

E-Media

DV401



SISTEMA DI MODULI PER LA COMUNICAZIONE AUDIO-VISIVA

MODULES SYSTEM FOR AUDIOVISUAL COMMUNICATION

SISTEMA DE MÓDULOS PARA LA COMUNICACIÓN AUDIO-VISUAL

SYSTEME DE MODULES POUR LA COMMUNICATION AUDIO-VISUELLE

MODULSYSTEME FÜR DIE AUDIO-VISUELLE KOMMUNIKATION

SISTEMA DE MÓDULOS PARA COMUNICAÇÃO AUDIO VISUAL

Simboli - symbols - símbolos - symboles - symbole - símbolos



articolo non in pronta consegna. Per la disponibilità contattare l'ufficio commerciale

item not in prompt delivery. Please contact the commercial department for cheking availability
producto no disponible en stock. Para la disponibilidad contactar con el departamento comercial
article non disponible en stock. Merci de contacter le service commercial pour vérifier la disponibilité
Dieses Produkt ist nicht sofort lieferbar. Setzen Sie sich mit unserem Handelsbüro in Verbindung für die Warenverfügbarkeit
produtos não pronta entrega. Acerca da disponibilidade, contactar o sector comercial



fino ad esaurimento

until exhaustion
hasta que se agoten
soumises à disponibilité
bis Erschöpfung
até à exaustão

V01 M1	<p>Piani di lavoro in melaminico sp. 25 mm, bordati in ABS perimetrale, colore IN TINTA CON I PIANI</p> <p>Melamine worktops 25 mm thick, with perimeter edge banding in ABS, WITH MATCHING WORKTOPS COLOUR Sobres de trabajo en melamina 25 mm de grosor, cantos perimétricos en ABS, ACABADO COORDINADO A LOS SOBRES Plans de travail en mélaminé ép. 25 mm, avec chants de périmètre en ABS, FINITION COORDONNÉE AUX PLANS Tischplatten aus Melamin St. 25 mm, mit ABS Kante, PASSEND ZU DEN TISCHPLATTEN DEKORE Planos de trabalho em melamínico esp. 25 mm, com fita de bordo em ABS, NA MESMA COR QUE A DOS PLANOS</p>
-----------	---

V02 M1	<p>Schiena in melaminico sp. 25 mm</p> <p>Melamine back 25 mm thick Trasera en melamina 25 mm de grosor Dos en mélaminé ép. 25 mm Rückwandblende aus Melamin St. 25 mm Costas en melamínico esp. 25 mm</p>
-----------	---

V03 M1	<p>Basamento sottopiano in melaminico sp. 25 mm</p> <p>Melamine undertop pedestal 25 mm thick Base bajo encimera en melamina de 25 mm de grosor Structure sous plateau en mélaminé ép.25 mm Tragender Unterbau aus Melamin St. 25 mm Base sob o plano de trabalho em melamínico esp. 25 mm</p>
-----------	---



Bianco
 White
 Blanco
 Blanc
 Weiss
 Branco

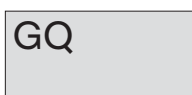

Grigio chiaro
 Light grey
 Gris claro
 Gris clair
 Hellgrau
 Cinza claro



Rovere chiaro
 Light oak
 Roble claro
 Chêne clair
 Eiche hell
 Carvalho claro



Noce "Maroncelli"
 Walnut "Maroncelli"
 Nogal "Maroncelli"
 Noyer "Maroncelli"
 Nussbaum "Maroncelli"
 Nogueira "Maroncelli"



Terra d'ombra
 Umber
 Tierra sombra
 Terre d'ombre
 Umbr
 Terra sombra



Rovere moro
 Dark oak
 Roble oscuro
 Chêne foncé
 Eiche dunkel
 Carvalho escuro



Rovere tabacco
 Tobacco Oak
 Roble tabaco
 Chêne tabac
 Eiche tabak
 Carvalho tabaco

V01 V02 V03 M2	<p>NO</p> <p>Nero opaco Black matt Negro mate Noir mat Schwarz matt Preto opaco</p>
-------------------------	---

DV401 E-media

Finiture - finishes - acabados - finitions - farben - acabamentos

V04	Staffe / Carter / Vassoio
	Brackets / Casing / Tray
	Soportes / Carter / Bandeja
	Supports / Carter / Plateau
	Halterungen / Carter / Tablett
	Suportes / Carter / Bandeja

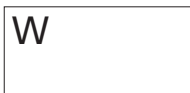

Bianco
White
Blanco
Blanc
Weiss
Branco



Alluminio
Aluminium
Aluminio
Aluminium
Aluminium
Aluminio

V13	Top access Alluminio
	Top access Aluminium
	Top access Aluminio
	Top access Aluminium
	Top Access Aluminium
	Top access Aluminio

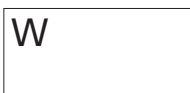

Bianco
White
Blanco
Blanc
Weiss
Branco



Alluminio
Aluminium
Aluminio
Aluminium
Aluminium
Aluminio



Nero anodizzato
Anodized black
Negro anodizado
Noir anodisé
eloxiert Schwarz
Preto anodizado

N.B.: Su specifica richiesta è possibile ordinare abbinamenti tra pannelli e piani di lavoro diversi da quelli previsti a listino. Eventuali richieste di pannelli DV401 con colorazioni e finiture differenti verranno valutate di volta in volta dall'ufficio commerciale.

N.B.: At your specific request you can order panels and working tops matched differently than those provided for in the price list. Any request for DV401 panels with different colours and finishes will be evaluated from time to time by commercial dept.

N.B.: Bajo específica solicitud es posible pedir combinaciones entre paneles y sobres de trabajo diferentes de las previstas en tarifH. Eventuales solicitudes de paneles DV401 con colores y acabados diferentes serán evaluadas en su momento por el departamento comercial.

N.B.: Sur demande spécifique, il est possible de commander des panneaux et plateaux à assortir différemment que ceux prévus dans le tarif. Toutes les demandes de panneaux DV401 de couleurs et finitions diverses seront examinées au cas par cas par le service commercial.

HINWEIS: Auf ausdrückliche Anfrage können andere Kombinationen von Paneelen und Arbeitsplatten als in der Preisliste angeführt bestellt werden. Der Preis für eventuelle Bestellungen von DV401-Paneelen in anderen Farben und Ausführungen wird von Fall zu Fall von der Handelsabteilung berechnet.

NOTA: Sob encomenda, é possível solicitar composições entre painéis e planos de trabalho diversos dos previstos na lista de produtos. Possíveis solicitações de painéis DV401 com colorações e acabamentos diferentes serão avaliadas pelo sector comercial.

DV401 E-media

Come ordinare - How to order

codice / code
401.SM.02.20

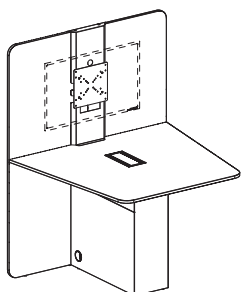

categoria prezzo / price category

- V01** piani / worktop
 → **NM**
- V03** schiena / back
 → **GQ**
- V04** staffe e carter / brackets and casing
 → **HH**
- V07** basamento / basement
 → **WN**
- V13** top access / top access
 → **H**

401SM0220

V01 - NM
V03 - GQ
V04 - HH
V07 - WN
V13 - H

Prezzo / Price
2.043

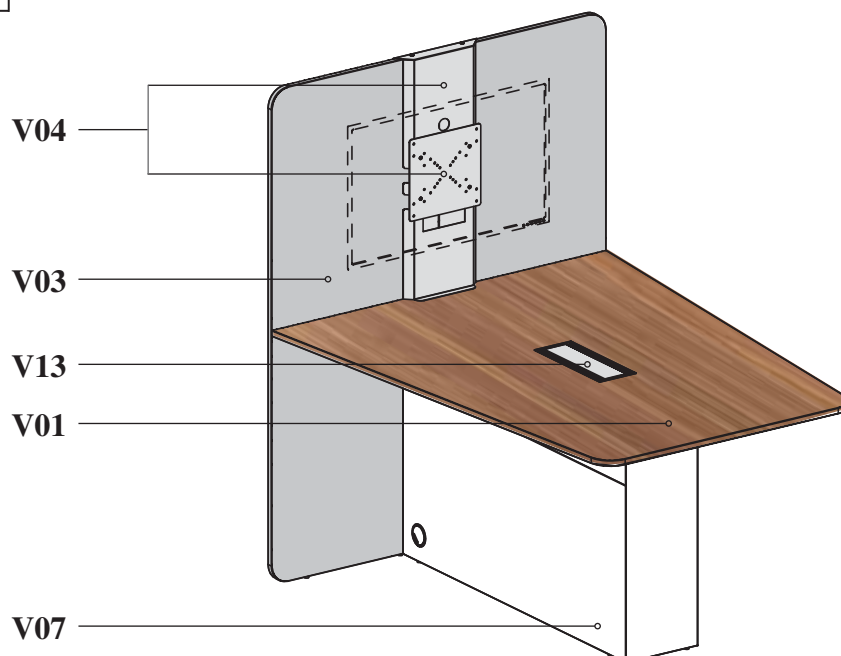

DV401 E-media

H. 174 cm

H. 68 1/2"

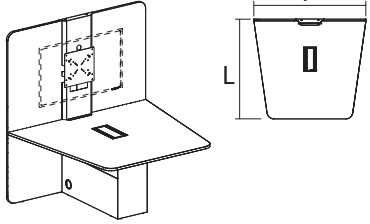
MODULI UNITS	L. W.	P. D.	H. H.	CODICE CODE	CATEGORIA PREZZO / PRICE CATEGORY		Kg. lb	m ³ ft ³	n. no.				
					S1	S2							
	142,5 56 1/8"	160 63"	174 68 1/2"	401.SM.01.14	1.785	2.146	137,30 302,74	0,416 14,69	12 12				
	202,5 79 3/4"	160 63"	174 68 1/2"	401.SM.01.20	1.865	2.202	168,30 371,10	0,518 18,30	12 12				
<p>modulo per la comunicazione audio visiva</p> <p>module for audio-visual communication</p> <p>módulo para la comunicación audio-video</p> <p>module pour la communication audio-visuelle</p> <p>Modul für die Audio-visuKommunikation</p> <p>módulo para comunicação áudio visual</p>					<p>1 Top access incluso</p> <p>1 Top access included</p> <p>1 Top access incluido</p> <p>1 Top access compris</p> <p>1 Top Access Inbegriffen</p> <p>1 Top access incluso</p> <p>Cod. 300.AC.20.04</p> <p>L.44,7 cm - W. 17 58"</p>								

S1	V01 piani worktops	WN	GQ	RC	TD	NM	RM	RT
	V03 schiena back	WN	GQ	RC	TD	NM	RM	RT
	V07 basamento basament	WN	GQ	RC	TD	NM	RM	RT
	V13 top access top access					W	H	N
	V04 staffa / carter / vassoio bracket / casings / tray					W	H	

S2	V01 piani worktops							NO
	V02 schiena back							NO
	V07 basamento basament							NO
	V13 top access top access					W	H	N
	V04 staffa / carter / vassoio bracket / casings / tray					W	H	

H. 207 cm

H. 81 1/2"

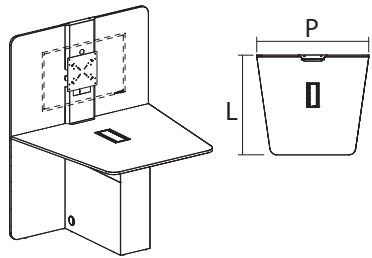
MODULI UNITS	L. W.	P. D.	H. H.	CODICE CODE	CATEGORIA PREZZO / PRICE CATEGORY		Kg. lb	m ³ ft ³	n. no.	
					S1	S2				
	142,5 56 1/8"	160 63"	207 81 1/2"	401.SM.02.14	1.894	2.297	159,10 350,81	0,477 16,85	12 12	
	202,5 79 3/4"	160 63"	207 81 1/2"	401.SM.02.20	2.043	2.467	196,50 433,28	0,597 21,09	12 12	
					1 Top access incluso 1 Top access included 1 Top access incluido 1 Top access compris 1 Top Access Inbegriffen 1 Top access incluso Cod. 300.AC.20.04 L.44,7 cm - W. 17 58"					
modulo per la comunicazione audio visiva module for audio-visual communication módulo para la comunicación audio-video module pour la communication audio-visuelle Modul für die Audio-visuKommunikation módulo para comunicação áudio visual										

S1	V01 piani worktops	WN	GQ	RC	TD	NM	RM	RT
	V03 schiena back	WN	GQ	RC	TD	NM	RM	RT
	V07 basamento basament	WN	GQ	RC	TD	NM	RM	RT
	V13 top access top access				W	H	N	
	V04 staffa / carter / vassoio bracket / casings / tray				W	H		

S2	V01 piani worktops							NO
	V02 schiena back							NO
	V07 basamento basament							NO
	V13 top access top access				W	H	N	
	V04 staffa / carter / vassoio bracket / casings / tray				W	H		

DV401 E-media

V04	vassoio tray	W	H
------------	-----------------	----------	----------

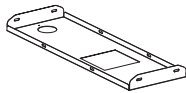
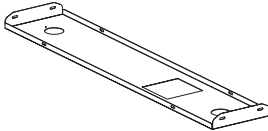
MODULI UNITS	L. W.	P. D.	H. H.	CODICE CODE	V04	Kg. lb	m ³ ft ³	n. no.
 <p>vassoio aggiuntivo per modulo P.142,5 cm 📏</p> <p>additional tray for module D.142,5 cm</p> <p>bandeja adicional para modulo P.142,5 cm</p> <p>plateau supplémentaire pour module P.142,5 cm</p> <p>zusätzliche Metallschahle für Modul T.142,5 cm</p> <p>bandeja adicional para módulo L.142,5 cm</p>	89,5 35 1/4"	61,5 24 1/4"	29,3 11 5/8"	401.VA.01.09	93	4,60 10,14	0,023 0,81	1 1
 <p>vassoio aggiuntivo per modulo P.202,5 cm 📏</p> <p>additional tray for module D.202,5 cm</p> <p>bandeja adicional para modulo L.202,5 cm</p> <p>plateau supplémentaire pour module P.202,5 cm</p> <p>zusätzliche Metallschahle für Modul T.202,5 cm</p> <p>bandeja adicional para módulo L.202,5 cm</p>	149,5 58 7/8"	61,5 24 1/4"	29,3 11 5/8"	401.VA.02.14	116	6,60 14,55	0,038 1,34	1 1