

Oxford

DV910



LINEA DIREZIONALE

EXECUTIVE LINE

SERIE EJECUTIVA

LIGNES DE DIRECTION

DIREKTIONSEINRICHTUNGSPROGRAMME

LINHA DIRECÇÃO

DV913
VIGO

DV911
NOTO

DV909
TOKIO

DV905
RYM

DV903
TAY

DV901
VERTIGO

DV902
PLANETA

DV914
DAKAR

DV910
OXFORD

Simboli - symbols - símbolos - symboles - symbole - símbolos

 **con serratura**
with lock
con cerradura
avec serrure
mit Schloss
com fechadura

 **articolo non in pronta consegna. Per la disponibilità contattare l'ufficio commerciale**
item not in prompt delivery. Please contact the commercial department for checking availability
producto no disponible en stock. Para la disponibilidad contactar con el departamento comercial
article non disponible en stock. Merci de contacter le service commercial pour vérifier la disponibilité
Dieses Produkt ist nicht sofort lieferbar. Setzen Sie sich mit unserem Handelsbüro in Verbindung für die Warenverfügbarkeit
produtos não pronta entrega. Acerca da disponibilidade, contactar o sector comercial

 **Posizione seduta**
Chair position
Posición asiento
Position siège
Stuhl Position
Posición asiento

DV910 Oxford

Finiture - finishes - acabados - finitions - farben - acabamentos

V01 **Piani di lavoro in melaminico sp. 38 mm**
 Melamine worktops 38 mm thick
 Sobres de trabajo en melamina 38 mm de grosor
 Plans de travail en melaminé ép. 38 mm
 Tischplatten aus Melamin St. 38 mm
 Planos de trabalho em melaminico esp. 38 mm



WN Bianco White Blanco Blanc Weiss Branco	RC Rovere chiaro Light oak Roble claro Chêne clair Eiche hell Carvalho claro	NM Noce "Maroncelli" Walnut "Maroncelli" Nogal "Maroncelli" Noyer "Maroncelli" Nussbaum "Maroncelli" Nogueira "Maroncelli"	RS Rovere scuro Dark oak Roble oscuro Chêne foncé Eiche dunkel Carvalho escuro
--	---	---	---

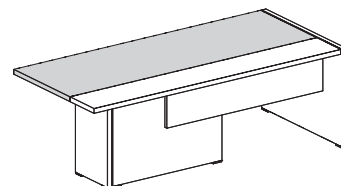

AR Arena Arena Arena Arena Arena	CF Caffe' Coffee Café Café Kaffee Café	JS Jasmine Jasmine Jasmine Jasmine Jasmine	NR Nero Black Negro Noir Schwartz Preto
--	---	--	--

V02 **Pianetto frontale piani composti sp. 38 mm**
 Front top for composed worktops 38 mm thick
 Sobres de trabajo frontal para sobre compuesto en melamina 38 mm de grosor
 Plans de travail fronl pour plateau composé en melaminé ép. 38 mm
 Tischplatten aus Melamin St. 38 mm
 Plano frontal de trabalho para tampo composto em melaminico esp. 38 mm



WN Bianco White Blanco Blanc Weiss Branco	RC Rovere chiaro Light oak Roble claro Chêne clair Eiche hell Carvalho claro	NM Noce "Maroncelli" Walnut "Maroncelli" Nogal "Maroncelli" Noyer "Maroncelli" Nussbaum "Maroncelli" Nogueira "Maroncelli"	RS Rovere scuro Dark oak Roble oscuro Chêne foncé Eiche dunkel Carvalho escuro
--	---	---	---

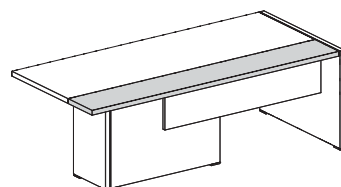

V02 **Gambe pannellate in melaminico sp. 38 mm**
 Panelled legs 38 mm thick
 Patas paneladas en melamina 38 mm de grosor
 Pieds panneaux en melaminé ép. 38 mm
 Wangenfuß aus Melamin St. 38 mm
 Pernas em painel en melaminico esp. 38 mm



WN Bianco White Blanco Blanc Weiss Branco	RC Rovere chiaro Light oak Roble claro Chêne clair Eiche hell Carvalho claro	NM Noce "Maroncelli" Walnut "Maroncelli" Nogal "Maroncelli" Noyer "Maroncelli" Nussbaum "Maroncelli" Nogueira "Maroncelli"	RS Rovere scuro Dark oak Roble oscuro Chêne foncé Eiche dunkel Carvalho escuro
--	---	---	---

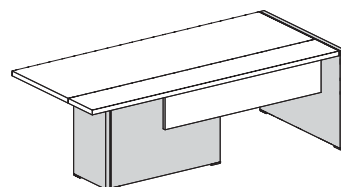

DV913 VIGO
 DV911 NOTO
 DV909 TOKIO
 DV905 RYM
 DV903 TAY
 DV901 VERTIGO
 DV902 PLANETA
 DV914 DAKAR
 DV910 OXFORD

DV910 Oxford

Finiture - finishes - acabados - finitions - farben - acabamentos

V01 Modesty panel
Modesty panel
Faldón
Voile de fond
Knieblende
Modesty panel



Bianco
White
Blanco
Blanc
Weiss
Branco



Rovere chiaro
Light oak
Roble claro
Chêne clair
Eiche hell
Carvalho claro



Noce "Maroncelli"
Walnut "Maroncelli"
Nogal "Maroncelli"
Noyer "Maroncelli"
Nussbaum "Maroncelli"
Nogueira "Maroncelli"

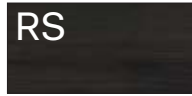

Rovere scuro
Dark oak
Roble oscuro
Chêne foncé
Eiche dunkel
Carvalho escuro

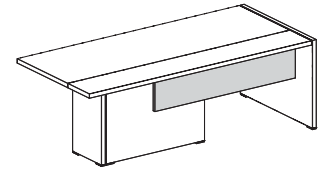

Arena
Arena
Arena
Arena
Arena
Arena



Caffe'
Coffee
Café
Café
Kaffee
Café



Jasmine
Jasmine
Jasmine
Jasmine
Jasmine
Jasmine



Nero
Black
Negro
Noir
Schwartz
Preto

V19 Alimentazione elettrica
Power supply
Alimentación eléctrica
Alimentation électrique
Stromversorgung
fonte de alimentação

EU

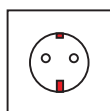

Presa per mercato EU
EU power outlet
Enchufe eléctrico EU
Prise électrique EU
Stecker für den EU-Markt
soquete elétrico EU

UK

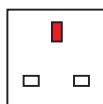

Presa per mercato UK
UK power outlet
Enchufe eléctrico UK
Prise électrique UK
Stecker für den UK-Markt
soquete elétrico US

US

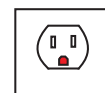

Presa per mercato US
US power outlet
Enchufe eléctrico US
Prise électrique US
Stecker für den UK-Markt
soquete elétrico US

DV910 Oxford

Finiture - finishes - acabados - finitions - farben - acabamentos

V02 **MOBILI DI SERVIZIO - Scocca in melaminico sp. 25/38 mm e ripiani in melaminico sp.25 mm**
 SERVICE UNITS - Bodies in melamine panels 25/38 mm thick and shelves in melamine panels 25 mm thick
 MUEBLE AUXILIAR - Cuerpo en melamina de 25/38 mm de grosor y estantes en melamina de 25 mm de grosor
 DESSERTTE - Coffre en mélaminé ép. 25/38 mm et tablettes en mélaminé ép. 25 mm
 BEISTELLMÖBEL - Korpus aus Melamin St. 25/38 mm und Einlegeböden aus Melamin St. 25 mm
 MÓVEL DE SERVIÇO - Estrutura em melamínico espessura 25/38 mm e prateleiras em melamínico espessura 25 mm

WN	RC	NM	RS
Bianco	Rovere chiaro	Noce "Maroncelli"	Rovere scuro
White	Light oak	Walnut "Maroncelli"	Dark oak
Blanco	Roble claro	Nogal "Maroncelli"	Roble oscuro
Blanc	Chêne clair	Noyer "Maroncelli"	Chêne foncé
Weiss	Eiche hell	Nussbaum "Maroncelli"	Eiche dunkel
Branco	Carvalho claro	Nogueira "Maroncelli"	Carvalho escuro

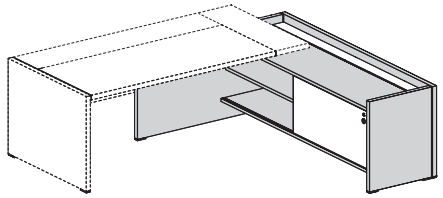

V01 **MOBILI DI SERVIZIO - Ante sp.18 mm bordate in ABS perimetrale**
 SERVICE UNITS - Doors 18 mm thick with perimeter edge banding in ABS
 MUEBLE AUXILIAR - Puertas de 18 mm de grosor, con cantos perimétricos en ABS
 DESSERTTE - Portes ép.18 mm avec chants de périmètre en ABS
 BEISTELLMÖBEL - Türen St. 18 mm mit ABS Kante
 MÓVEL DE SERVIÇO - Portas espessura 18 mm orladas a ABS perimetral

WN	RC	NM	RS
Bianco	Rovere chiaro	Noce "Maroncelli"	Rovere scuro
White	Light oak	Walnut "Maroncelli"	Dark oak
Blanco	Roble claro	Nogal "Maroncelli"	Roble oscuro
Blanc	Chêne clair	Noyer "Maroncelli"	Chêne foncé
Weiss	Eiche hell	Nussbaum "Maroncelli"	Eiche dunkel
Branco	Carvalho claro	Nogueira "Maroncelli"	Carvalho escuro

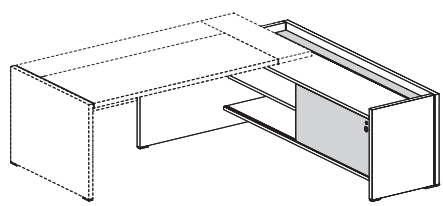

AR	CF	JS	NR
Arena	Caffe'	Jasmine	Nero
Arena	Coffee	Jasmine	Black
Arena	Café	Jasmine	Negro
Arena	Café	Jasmine	Noir
Arena	Kaffee	Jasmine	Schwartz
Arena	Café	Jasmine	Preto

V81 **Moblie di servizio - LATO SINISTRO (SX) o LATO DESTRO (DX)**
 Service unit - LEFT HAND (SX) or RIGHT HAND (DX)
 Mueble auxiliar - LADO IZQUIERDO (SX) o LADO DERECHO (DX)
 Desserte - CÔTÉ GAUCHE (SX) ou CÔTÉ DROITE (DX)
 Beistellschrank - LINKS (SX) oder RECHT (DX)
 Móvel de serviço - LATERAL ISQUIERDA (SX) ou LATERAL DIREITO (DX)

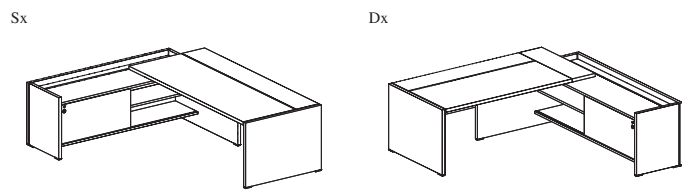

DV913 VIGO
 DV911 NOTO
 DV909 TOKIO
 DV905 RYM
 DV903 TAY
 DV901 VERTIGO
 DV902 PLANETA
 DV914 DAKAR
 DV910 OXFORD

DV910 Oxford

Finiture - finishes - acabados - finitions - farben - acabamentos

V01 MOBILI MULTIFUNZIONE - Ante in melaminico sp. 18 mm / Piani di lavoro in melaminico sp. 38 mm
 MULTI-PURPOSE STORAGE UNIT - Melamine doors 18 mm thick / Melamine worktops 38 mm thick
 MUEBLE MULTIUSO - Puertass en melamina 18 mm de grosor / Sobres de trabajo en melamina 38 mm de grosor
 MEUBLE MULTIFONCTION - Portes en melaminé ép. 18 mm / Plans de travail en melaminé ép. 38 mm
 MULTIFUNKTIONS-MÖBEL - Türen aus Melamin St. 18 mm / Tischplatten aus Melamin St. 38 mm
 ARMÁRIO MULTIFUNCIONAL - Portas en melaminico esp. 18 mm / Planos de trabalho en melaminico esp. 38 mm

WN	RC	NM	RS
Bianco	Rovere chiaro	Noce "Maroncelli"	Rovere scuro
White	Light oak	Walnut "Maroncelli"	Dark oak
Blanco	Roble claro	Nogal "Maroncelli"	Roble oscuro
Blanc	Chêne clair	Noyer "Maroncelli"	Chêne foncé
Weiss	Eiche hell	Nussbaum "Maroncelli"	Eiche dunkel
Branco	Carvalho claro	Nogueira "Maroncelli"	Carvalho escuro
AR	CF	JS	NR
Arena	Caffe'	Jasmine	Nero
Arena	Coffee	Jasmine	Black
Arena	Café	Jasmine	Negro
Arena	Café	Jasmine	Noir
Arena	Kaffee	Jasmine	Schwartz
Arena	Café	Jasmine	Preto

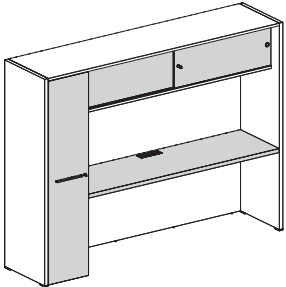

V04 MOBILI MULTIFUNZIONE - Scocche in melaminico sp. 38 mm
 MULTI-PURPOSE STORAGE UNIT - Melamine bodies 38 mm thick
 MUEBLE MULTIUSO - Cuerpos en melamina 38 mm de grosor
 MEUBLE MULTIFONCTION - Coffres en melaminé ép. 38 mm
 MULTIFUNKTIONS-MÖBEL - Korpus aus Melamin St. 38 mm
 ARMÁRIO MULTIFUNCIONAL - Corpo en melaminico esp. 38 mm

WN	RC	NM	RS
Bianco	Rovere chiaro	Noce "Maroncelli"	Rovere scuro
White	Light oak	Walnut "Maroncelli"	Dark oak
Blanco	Roble claro	Nogal "Maroncelli"	Roble oscuro
Blanc	Chêne clair	Noyer "Maroncelli"	Chêne foncé
Weiss	Eiche hell	Nussbaum "Maroncelli"	Eiche dunkel
Branco	Carvalho claro	Nogueira "Maroncelli"	Carvalho escuro

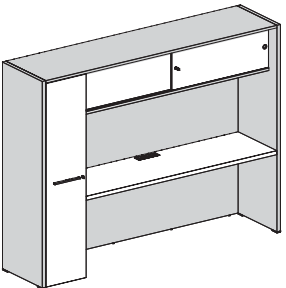

V81 MOBILI MULTIFUNZIONE - Anta con maniglia lato sinistro (sx) o lato destro (dx)
 MULTI-PURPOSE STORAGE UNIT - Door with handle left hand (sx) or right hand (dx)
 MUEBLE MULTIUSO - Puertata con tirador lado izq (sx) o lado drch (dx)
 MEUBLE MULTIFONCTION - Porte avec poignée côté gauche (sx) ou côté droite (dx)
 MULTIFUNKTIONS-MÖBEL - Tür mit griff links (sx) oder recht (dx)
 ARMÁRIO MULTIFUNCIONAL - Porta com puxadored lateral isquierda (sx) ou lateral direito (dx)

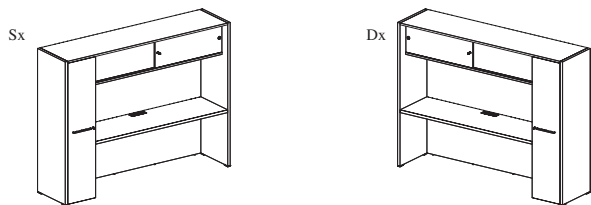

V06 MOBILI MULTIFUNZIONE - Schiena pinnabile
 MULTI-PURPOSE STORAGE UNIT - Pinnable back panel
 MUEBLE MULTIUSO - Trasera pinnable para
 MEUBLE MULTIFONCTION - Dos pinnable pour
 MULTIFUNKTIONS-MÖBEL - Pinnable Rückwand
 ARMÁRIO MULTIFUNCIONAL - Fundo "pinnable"



Rivestimento in poliester 100% Trevira CS

Polyester 100% Trevira CS coating
 Revestimiento en polyester 100% Trevira CS
 Revêtement en polyéster 100% Trevira CS
 Beistellschrank aus polyester 100% Trevira CS
 Revestimento em polyéster 100% Trevira CS

JB9109	JB9110	JB9804	JB9806
JB9109 - Pepe	JB9110 - Sesamo	JB9804 - Timo	JB9806 - Liquirizia
JB9109 - Pepper	JB9110 - Sesame	JB9804 - Thyme	JB9806 - Licorice
JB9109 - Pimienta	JB9110 - Sésamo	JB9804 - Tomillo	JB9806 - Regaliz
JB9109 - Poivre	JB9110 - Sésame	JB9804 - Thym	JB9806 - Réglisse
JB9109 - Pfeffer	JB9110 - Sesam	JB9804 - Thymian	JB9806 - Lakritze
JB9109 - Pimenta	JB9110 - Sésamo	JB9804 - Tomilho	JB9806 - Alcaçuz

DV910 Oxford

Finiture - finishes - acabados - finitions - farben - acabamentos

V01 CASSETTIERE - Frontali cassetti in melaminico sp. 18 mm
 PEDESTALS - Melamine drawers fronts 18 mm thick
 CAJONERAS - Frentes de cajones en melamina 18 mm de grosor
 CAISSON - Façades des tiroirs en melaminé ép. 18 mm
 SCHUBLADENELEMENT - Schubladenfronten aus Melamin St. 18 mm
 GAVETEIROS - Frentes de gaveta en melaminico esp. 18 mm



WN	RC	NM	RS
Bianco	Rovere chiaro	Noce "Maroncelli"	Rovere scuro
White	Light oak	Walnut "Maroncelli"	Dark oak
Blanco	Roble claro	Nogal "Maroncelli"	Roble oscuro
Blanc	Chêne clair	Noyer "Maroncelli"	Chêne foncé
Weiss	Eiche hell	Nussbaum "Maroncelli"	Eiche dunkel
Branco	Carvalho claro	Nogueira "Maroncelli"	Carvalho escuro



AR	CF	JS	NR
Arena	Caffe'	Jasmine	Nero
Arena	Coffee	Jasmine	Black
Arena	Café	Jasmine	Negro
Arena	Café	Jasmine	Noir
Arena	Kaffee	Jasmine	Schwartz
Arena	Café	Jasmine	Preto

V04 CASSETTIERE - Scocche in melaminico sp. 18 mm
 PEDESTALS - Melamine bodies 18 mm thick
 CAJONERAS - Cuerpos en melamina 18 mm de grosor
 CAISSON - Coffres en melaminé ép. 18 mm
 SCHUBLADENELEMENT - Korpus aus Melamin St. 18 mm
 GAVETEIROS - Corpo en melaminico esp. 18 mm



WN	RC	NM	RS
Bianco	Rovere chiaro	Noce "Maroncelli"	Rovere scuro
White	Light oak	Walnut "Maroncelli"	Dark oak
Blanco	Roble claro	Nogal "Maroncelli"	Roble oscuro
Blanc	Chêne clair	Noyer "Maroncelli"	Chêne foncé
Weiss	Eiche hell	Nussbaum "Maroncelli"	Eiche dunkel
Branco	Carvalho claro	Nogueira "Maroncelli"	Carvalho escuro

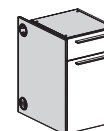

XBR

Maniglia per ante e cassetti (di serie)

Handle for doors and drawers (standard)
 Tirador para puertas y cajones (estándar)
 Poignée pour portes et tiroirs (standard)
 Standardgriff für Türen und Schubladen
 Puxadores para portas e gavetas (standard)

Int. 96 mm - L. 106 mm
 Int. 256 mm - L. 266 mm
 Int. 512 mm - L. 522 mm

DV913 VIGO
 DV911 NOTO
 DV909 TOKIO
 DV905 RYM
 DV903 TAY
 DV901 VERTIGO
 DV902 PLANETA
 DV914 DAKAR
 DV910 OXFORD

DV910 Oxford

Come ordinare - How to order

CODICE CODE	L. W.	P. D.	H. H.
910.TS.59.20	200 78 3/4"	90 35 1/2"	75 29 5/8"

Tavolo scrivania con piano composto

Desk with composed worktop

Mesa despacho con sobre compuesto

Bureau avec plateau composé

Besprechungstisch mit mehrteiliger Arbeitsplatte

Mesa escritorio com tampo composto

Diagram of desk 910.TS.59.20 showing components: V01 (piani worktops, modesty panel), V81 (verso hand), V02 (piano frontale frontal top, gambe legs), NR (modesty panel), Sx (hand), NM (frontal top, legs). Price: € 1.033.

CODICE CODE	L. W.	P. D.	H. H.
910.TM.33.25	250 98 1/2"	210 82 3/4"	75 29 5/8"

Tavolo scrivania con piano sliding, mobile di servizio H.65 con anta scorrevole e piano composto

Desk with sliding top with service unit H.65 with sliding door and composed worktop

Mesa con sobre deslizante, mueble auxiliar H. 65 con puerta corredera y sobre compuesto

Bureau avec plateau coulissant, desserte H. 65 avec porte coulissante et plateau composé

Schreibtisch mit Sliding Arbeitsplatte und Beistellmöbel H.65 mit Schiebetür und mehrteiliger Tischplatte

Mesa escritorio com tampo deslizante, móvel de serviço H.65 com anta deslizante e tampo composto

Diagram of desk 910.TM.33.25 showing components: V01 (piani worktops, modesty panel), V81 (verso hand), V02 (piano frontale frontal top, gambe legs), CF (modesty panel), Dx (hand), NM (frontal top, legs). Price: € 2.720.

CODICE CODE	L. W.	P. D.	H. H.
910.CM.P2.20	250 98 1/2"	276 108 3/4"	190 74 7/8"

Composizione con piano composto e contenitore multifunzione

Composition with composed worktop and multi-purpose storage unit

Composición con sobre de trabajo compuesto y mueble multiuso

Composition avec plateau composé et meuble multifonction

Komposition mit mehrteiliger Tischplatte und Multifunktions-Möbel

Composição com tampo composto e armário multifuncional

Diagram of desk 910.CM.P2.20 showing components: V01 (piani worktops, modesty panel), V81 (verso hand), V02 (piano frontale frontal top, gambe legs), AR (modesty panel), Sx (hand), RC (frontal top, legs). Price: € 4.250.

DV910 Oxford

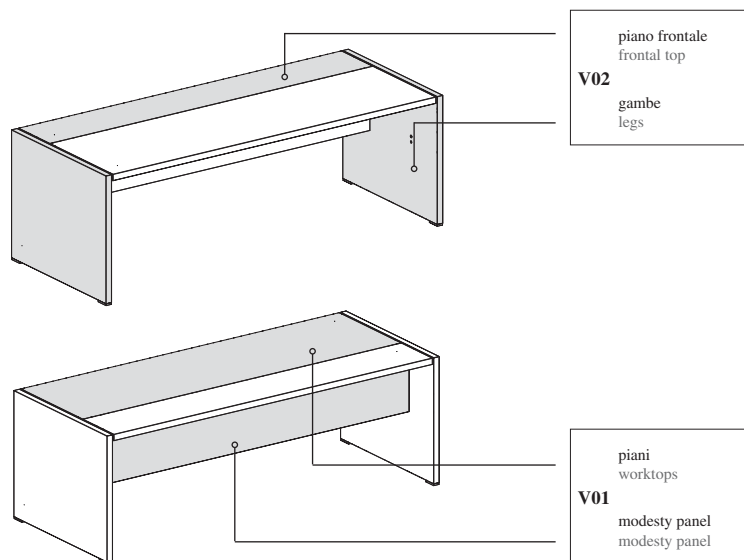
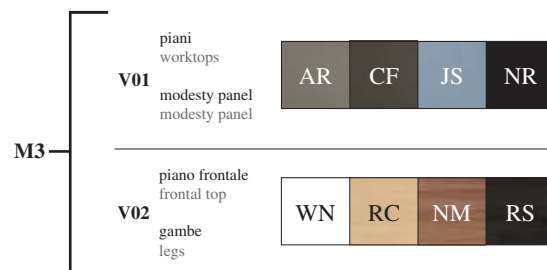
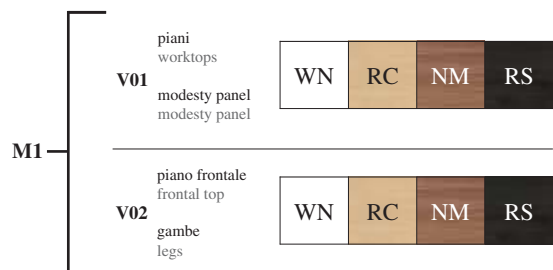

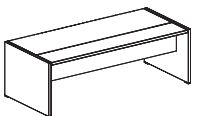
TAVOLI SCRIVANIA DESKS	L. W.	P. D.	H. H.	CODICE CODE	CATEGORIA PREZZO / PRICE CATEGORY		Kg. lb	m ³ ft ³	n. no.
					M1	M3			
 Tavolo scrivania Desk Mesa despacho Bureau Schreibtisch Mesa scrivania	204 80 3/8"	90 35 1/2"	75 29 5/8"	910.TS.68.20	883	917	96,50 212,78	0,220 7,77	4 4
	224 88 1/4"	90 35 1/2"	75 29 5/8"	910.TS.68.22	1.043	1.077	102,00 224,91	0,234 8,26	4 4

DV913 VIGO
DV911 NOTO
DV909 TOKIO
DV905 RYM
DV903 TAY
DV901 VERTIGO
DV902 PLANETA
DV914 DAKAR
DV910 OXFORD

DV910 Oxford

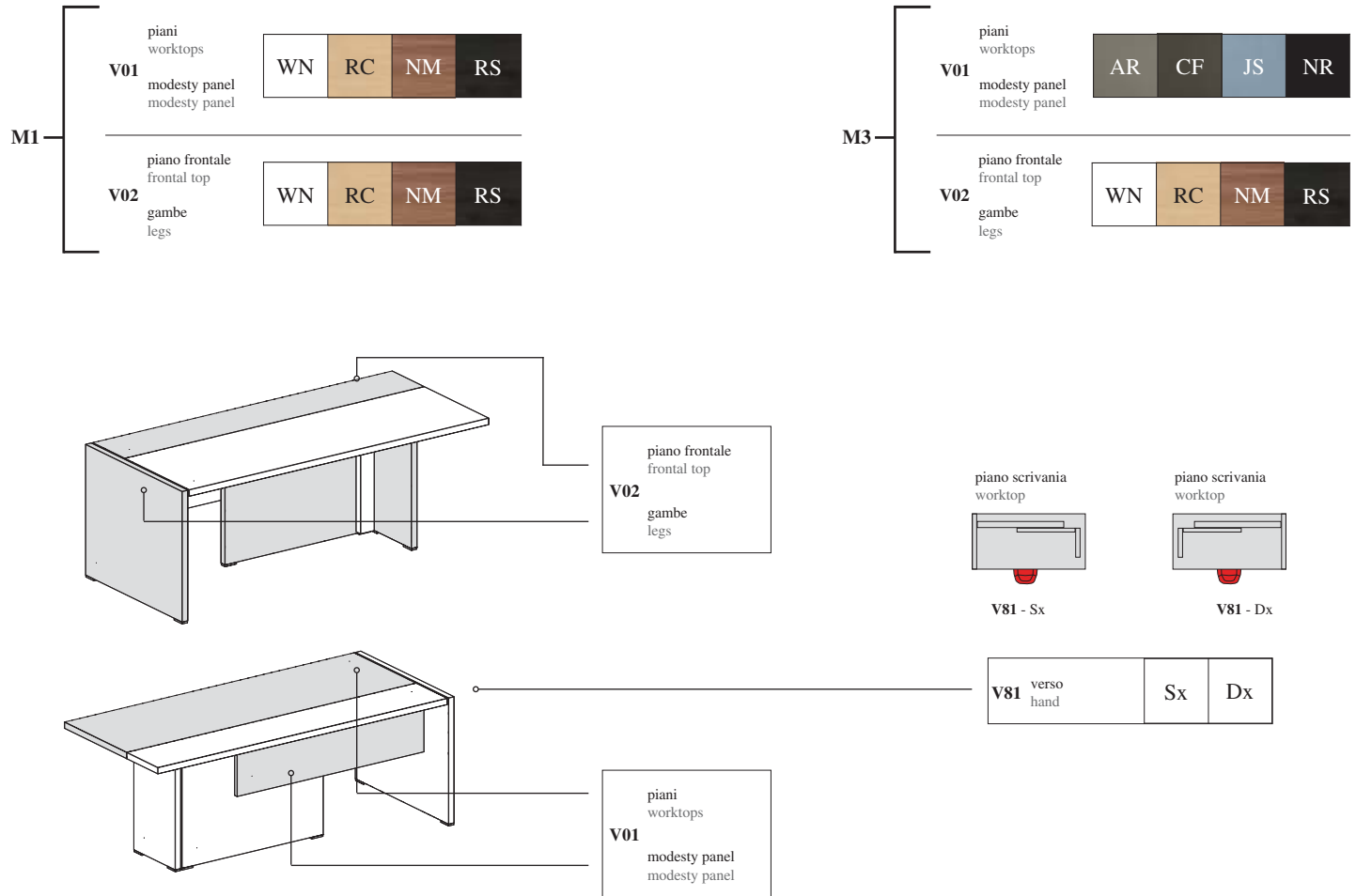

TAVOLI SCRIVANIA DESKS	L. W.	P. D.	H. H.	CODICE CODE	CATEGORIA PREZZO / PRICE CATEGORY		Kg. lb	m³ ft³	n. no.
					M1	M3			
	200 78 3/4"	90 35 1/2"	75 29 5/8"	910.TS.59.20	1.019	1.033	101,00 222,70	0,238 8,40	7 7
	220 86 5/8"	90 35 1/2"	75 29 5/8"	910.TS.59.22	1.127	1.132	107,00 235,93	0,248 8,76	7 7
<p>Tavolo scrivania con piano composto</p> <p>Desk with composed worktop</p> <p>Mesa despacho con sobre compuesto</p> <p>Bureau avec plateau composé</p> <p>Besprechungstisch mit mehrteiliger Arbeitsplatte</p> <p>Mesa escritorio com tampo composto</p>									

DV910 Oxford

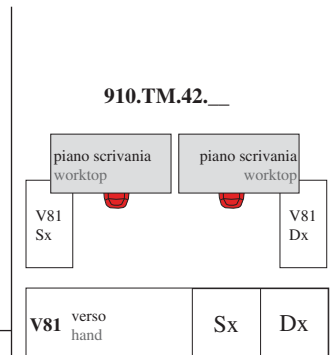
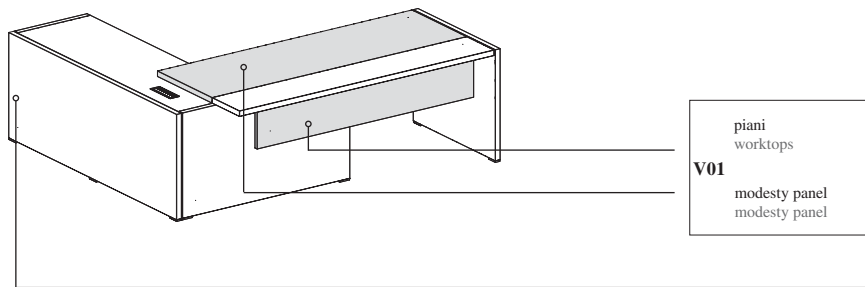
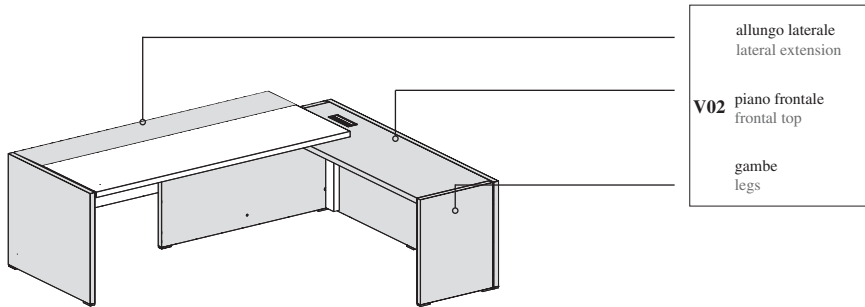
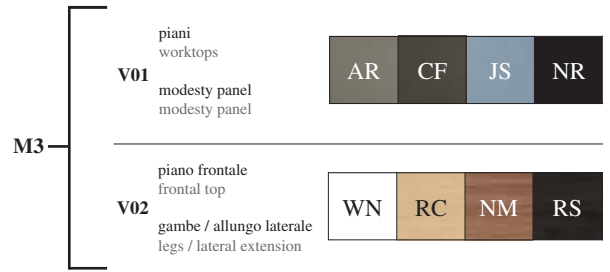
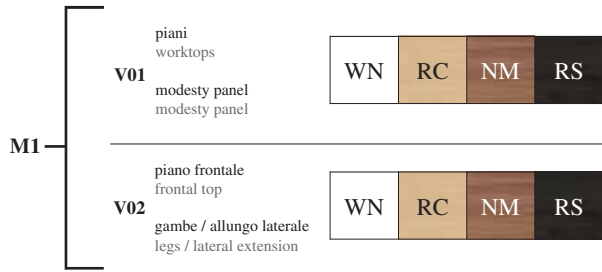

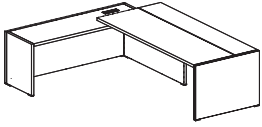
TAVOLI SU ALLUNGO H.71 DESKS ON LATERAL EXTENSION H.71	LT TW	L. W.	P. D.	H. H.	CODICE CODE	CATEGORIA PREZZO / PRICE CATEGORY		Kg. lb	m ³ ft ³	n. no.
						M1	M3			
 <p>Tavolo scrivania con piano composto e con allungo H.71 cm Desk with composed worktop and extension H. 71 cm Mesa despacho con sobre compuesto y alargó lateral H. 71 cm Bureau avec plateau composé et retour H. 71 cm Schreibtisch mit mehrteiliger Tischplatte und Anschluss H.71 cm Mesa escritorio com tampo composto e tampo complementar H.71 cm</p>	200 78 3/4"	230 90 5/8"	210 82 3/4"	75 29 5/8"	910.TM.42.23	1.764	1.777	175,00 385,87	0,400 14,13	10 10
	220 86 5/8"	250 98 1/2"	210 82 3/4"	75 29 5/8"	910.TM.42.25	1.876	1.880	181,50 400,20	0,414 14,62	10 10

DV913 VIGO
DV911 NOTO
DV909 TOKIO
DV905 RYM
DV903 TAY
DV901 VERTIGO
DV902 PLANETA
DV914 DAKAR
DV910 OXFORD

DV910 Oxford

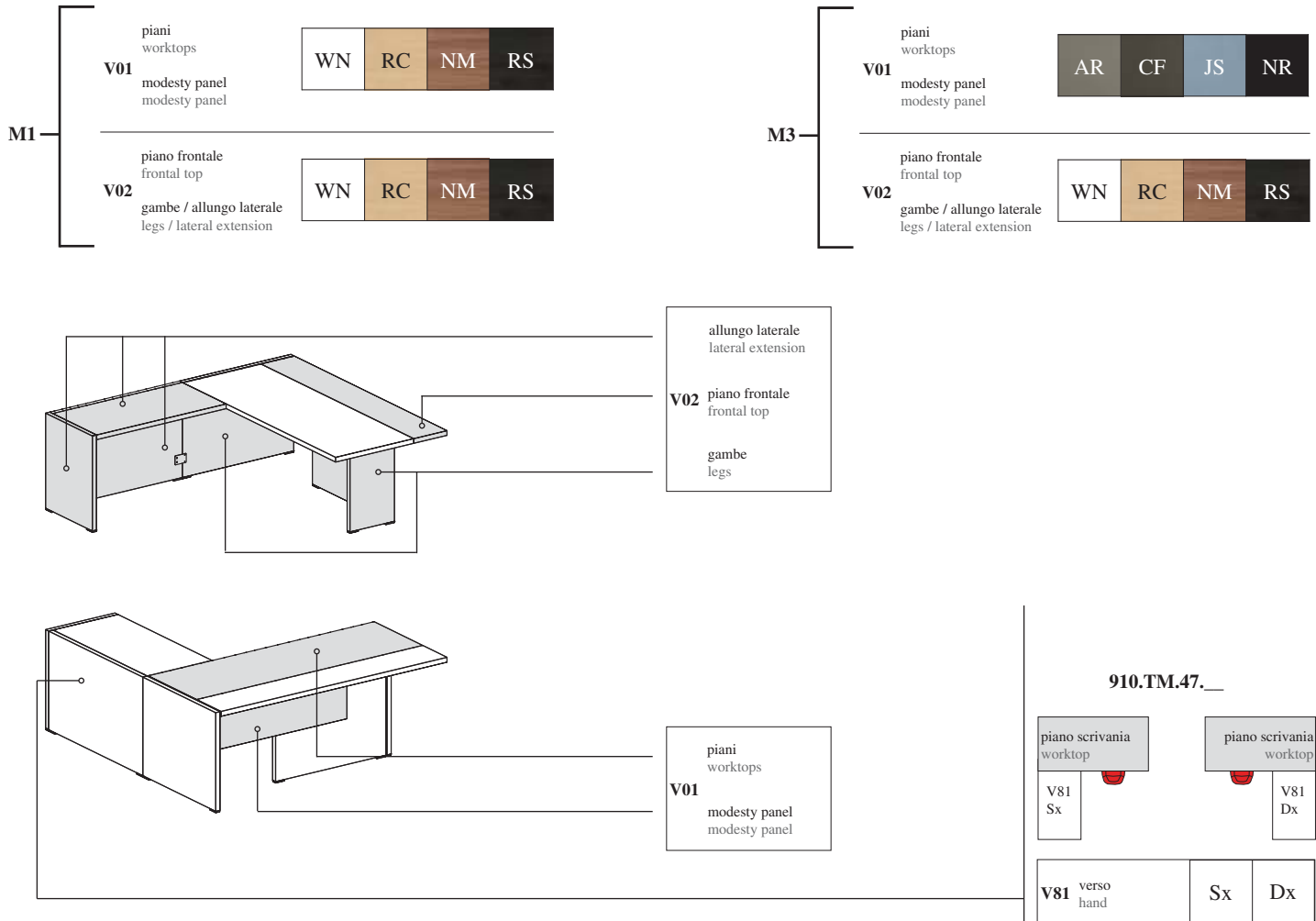

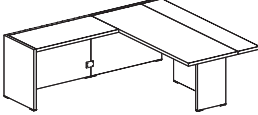
TAVOLI CON ALLUNGO DESK WITH EXTENSION	L. W.	P. D.	H. H.	CODICE CODE	CATEGORIA PREZZO / PRICE CATEGORY		Kg. lb	m ³ ft ³	n. no.
					M1	M3			
	200 78 3/4"	210 82 3/4"	75 29 5/8"	910.TM.47.20	1.621	1.635	157,50 347,28	0,360 12,72	12 12
	220 86 5/8"	210 82 3/4"	75 29 5/8"	910.TM.47.22	1.729	1.734	163,50 360,51	0,370 13,07	12 12
Tavolo scrivania con piano composto e con allungo H.75 cm Desk with composed worktop and extension H. 75 cm Mesa despacho con sobre compuesto y alargó lateral H. 75 cm Bureau avec plateau composé et retour H. 75 cm Schreibtisch mit mehrteiliger Tischplatte und Anschluss H.75 cm Mesa escritorio con tampo compuesto e tampo complementar H.75 cm									

DV910 Oxford

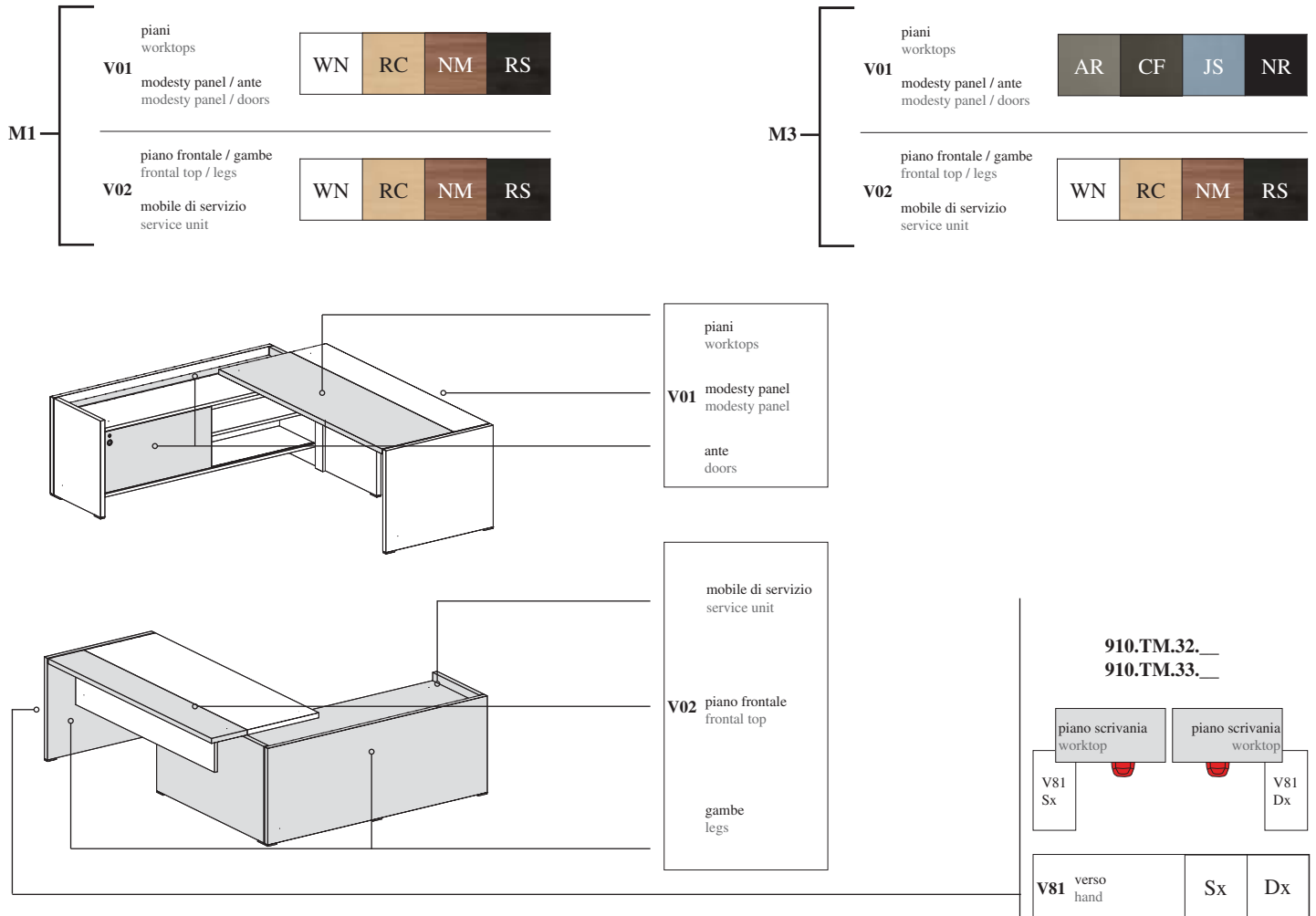

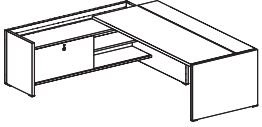
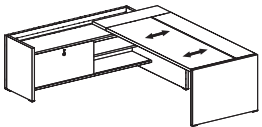
TAVOLI CON MOBILI DI SERVIZIO DESK WITH SERVICE UNIT	LT TW	L. W.	P. D.	H. H.	CODICE CODE	CATEGORIA PREZZO / PRICE CATEGORY		Kg. lb	m ³ ft ³	n. no.
						M1	M3			
 <p>Tavolo scrivania con mobile di servizio H.65 con anta scorrevole e piano composto Desk with service unit H.65 with sliding door and composed worktop Mesa despacho con mueble auxiliar H. 65 con puerta corredera y sobre compuesto Bureau avec desserte H. 65 avec porte coulissante et plateau composé Schreibtisch mit Beistellmöbel H.65 mit Schiebetür und mehrteiliger Tischplatte Mesa escritoria con móvel de serviço H.65 com anta deslizante e tampo composto</p>	200 78 3/4"	230 90 5/8"	210 82 3/4"	75 29 5/8"	910.TM.32.23	2.422	2.438	211,50 466,35	0,503 17,77	16 16
	220 86 5/8"	250 98 1/2"	210 82 3/4"	75 29 5/8"	910.TM.32.25	2.534	2.541	218,00 480,69	0,517 18,26	16 16
	200 78 3/4"	230 90 5/8"	210 82 3/4"	75 29 5/8"	910.TM.33.23	2.683	2.688	218,50 481,79	0,521 18,40	19 19
 <p>Tavolo scrivania con piano sliding, mobile di servizio H.65 con anta scorrevole e piano composto Desk with sliding top with service unit H.65 with sliding door and composed worktop Mesa con sobre deslizante, mueble auxiliar H. 65 con puerta corredera y sobre compuesto Bureau avec plateau coulissant, desserte H. 65 avec porte coulissante et plateau composé Schreibtisch mit Sliding Arbeitsplatte und Beistellmöbel H.65 mit Schiebetür und mehrteiliger Tischplatte Mesa escritoria com tampo deslizante, móvel de serviço H.65 com anta deslizante e tampo composto</p>	220 86 5/8"	250 98 1/2"	210 82 3/4"	75 29 5/8"	910.TM.33.25	2.703	2.720	224,50 495,02	0,535 18,90	19 19

DV913 VIGO
DV911 NOTO
DV909 TOKIO
DV905 RYM
DV903 TAY
DV901 VERTIGO
DV902 PLANETA
DV914 DAKAR
DV910 OXFORD

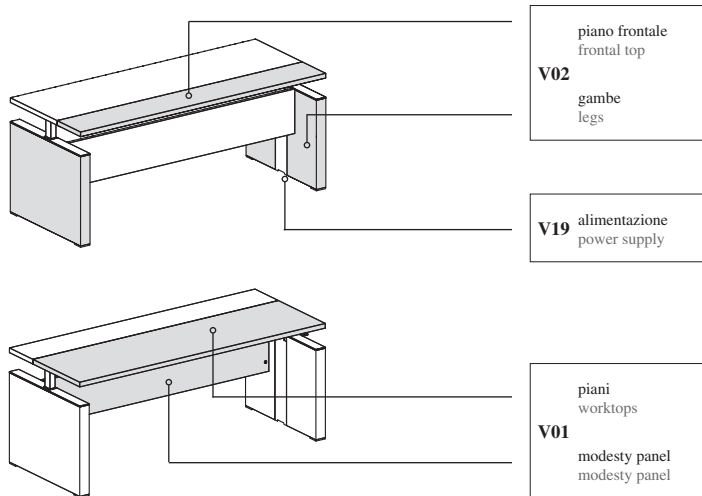
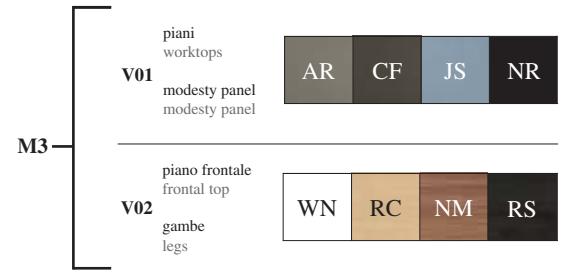
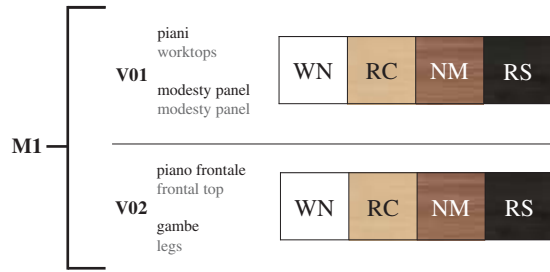

V19 alimentazione power supply	EU	UK	US
--	----	----	----

Tastierino per regolazione altezza piano (Standard)
Keypad for worktop height adjustment (Standard)
Teclado para ajuste altura sobre de trabajo (Standard)
Clavier pour réglage hauteur plan de travail (Standard)
Tastatur für die Höhe Einstellung (Standard)
Teclas para regulação em altura do tampo (Standard)

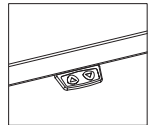

Tastierino per regolazione altezza piano con memorie
Control pad with memories for height adjustable worktop
Unidad de control con memorias para regulación altura sobre de trabajo
Clavier pour le réglage de la hauteur plateau avec mémoires de positions
Tastatur zur Höhenverstellung mit Speicher
Teclado com memória para regulação da altura do tampo

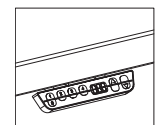

Articolo su richiesta - vedi pag.16
Item on demand - see page 16
Artículo su específica - ver pagina 16
Article sur demande - voir page 16
Artikel auf Anfrage - siehe Seite 16
Artigo sob encomenda - ver pag. 16

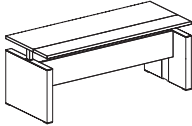
TAVOLI SCRIVANIA DESKS	L. W.	P. D.	H. H.	CODICE CODE	V19	CATEGORIA PREZZO / PRICE CATEGORY		Kg. lb	m³ ft³	n. no.
						M1	M3			
	200 78 3/4"	90 35 1/2"	77÷142 30 1/4÷56"	910.TS.69.20	EU	3.459	3.467	142,10 313,33	0,448 15,83	10 10
						3.459	3.467	142,10 313,33	0,448 15,83	10 10
						3.459	3.467	142,10 313,33	0,448 15,83	10 10
						3.459	3.467	142,10 313,33	0,448 15,83	10 10
Tavolo scrivania regolabile in altezza	220 86 5/8"	90 35 1/2"	77 ÷142 30 1/4÷56"	910.TS.69.22	EU	3.524	3.570	147,30 324,79	0,491 17,34	10 10
Desk with height adjustment						3.524	3.570	147,30 324,79	0,491 17,34	10 10
Mesa ajustables en altura						3.524	3.570	147,30 324,79	0,491 17,34	10 10
table de bureau avec réglage en hauteur						3.524	3.570	147,30 324,79	0,491 17,34	10 10
Schreibtische mit Höheneinstellung										
Mesa escritivaninha com regulagem de altura										

CANALIZZAZIONE TAVOLI SCRIVANIA CON REGOLAZIONE ELETTRICA IN ALTEZZA

Wire management desks with electric height adjustment / Canalización mesas con ajuste de altura eléctrico / Goulotte bureaux avec réglage hauteur électrique / Kabelkanal bei Tischen mit elektrischer Höheneinstellung / Calha técnica de secretária com regulação eléctrica em altura

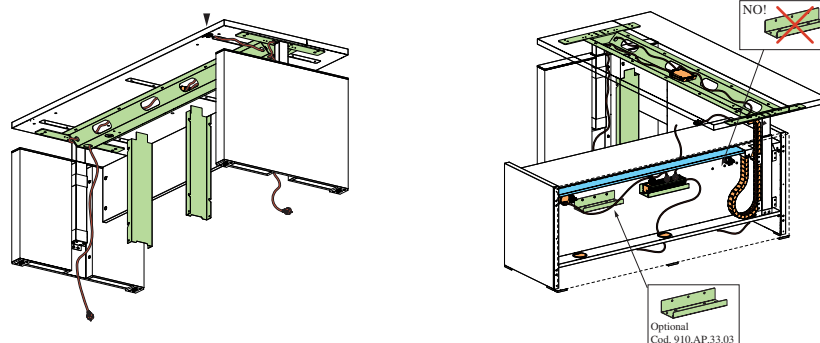

DV910 Oxford

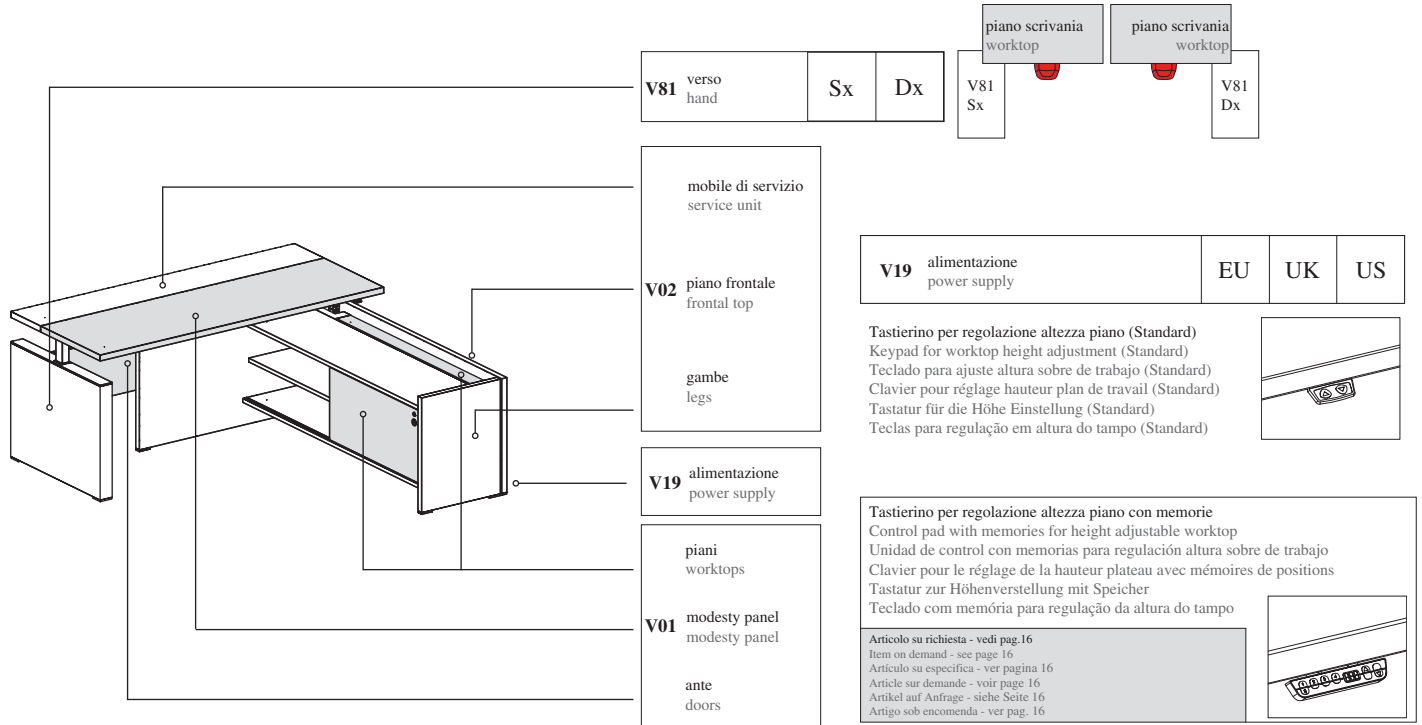
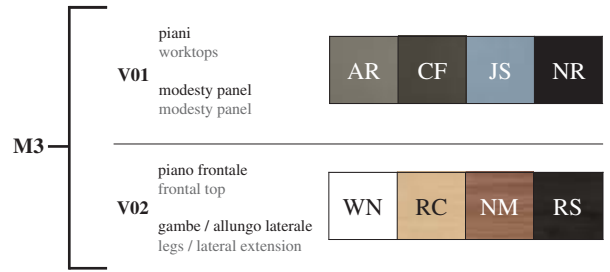
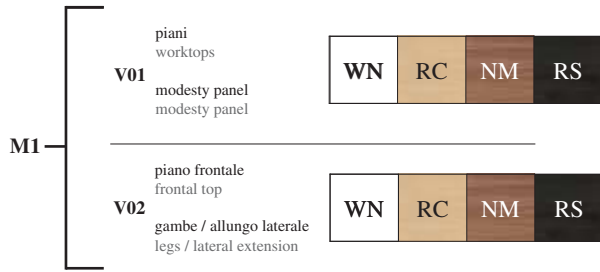

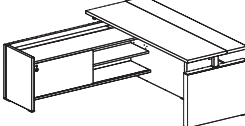
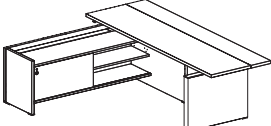
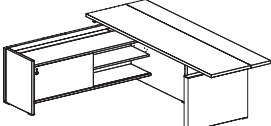

TAVOLI CON MOBILI DI SERVIZIO DESK WITH SERVICE UNIT	L. W.	P. D.	H. H.	CODICE CODE	V19	CATEGORIA PREZZO / PRICE CATEGORY		Kg. lb	m ³ ft ³	n. no.
						M1	M3			
 <p>Tavolo scrivania con mobile di servizio H.65 e piano composto, regolabile in altezza Desk with service unit H.65 with sliding door and composed worktop, with height adjustment Mesa despacho con mueble auxiliar H. 65 con puerta corredera y sobre compuesto, ajustables en altura Bureau avec desserte H. 65 avec porte coulissante et plateau composé, réglage en hauteur Schreibtisch mit Beistellmöbel H.65 mit Schiebetür und mehrteiliger Tischplatte, mit Höheneinstellung Mesa escrivaninhac om móvel de serviço H.65 com anta deslizante e tampo composto, regulagem de altura</p>	200 78 3/4"	214 84 1/4"	77÷142 30 1/4÷56"	910.TM.34.20	EU	4.552	4.556	252.10 555,88	0,675 23,85	19
					UK	4.552	4.556	252.10 555,88	0,675 23,85	19
					US	4.552	4.556	252.10 555,88	0,675 23,85	19
 <p>Tavolo scrivania con mobile di servizio H.65 e piano composto, regolabile in altezza Desk with service unit H.65 with sliding door and composed worktop, with height adjustment Mesa despacho con mueble auxiliar H. 65 con puerta corredera y sobre compuesto, ajustables en altura Bureau avec desserte H. 65 avec porte coulissante et plateau composé, réglage en hauteur Schreibtisch mit Beistellmöbel H.65 mit Schiebetür und mehrteiliger Tischplatte, mit Höheneinstellung Mesa escrivaninhac om móvel de serviço H.65 com anta deslizante e tampo composto, regulagem de altura</p>	220 86 5/8"	214 84 1/4"	77÷142 30 1/4÷56"	910.TM.34.22	EU	4.605	4.637	256.40 565,36	0,715 25,26	19
					UK	4.605	4.637	256.40 565,36	0,715 25,26	19
					US	4.605	4.637	256.40 565,36	0,715 25,26	19
 <p>Tavolo scrivania con mobile di servizio H.65 e piano composto, regolabile in altezza Desk with service unit H.65 with sliding door and composed worktop, with height adjustment Mesa despacho con mueble auxiliar H. 65 con puerta corredera y sobre compuesto, ajustables en altura Bureau avec desserte H. 65 avec porte coulissante et plateau composé, réglage en hauteur Schreibtisch mit Beistellmöbel H.65 mit Schiebetür und mehrteiliger Tischplatte, mit Höheneinstellung Mesa escrivaninhac om móvel de serviço H.65 com anta deslizante e tampo composto, regulagem de altura</p>	270 106 3/8"	214 84 1/4"	77 ÷142 30 1/4÷56"	910.TM.34.27	EU	4.694	4.701	271.60 598,87	0,728 25,72	19
					UK	4.694	4.701	271.60 598,87	0,728 25,72	19
					US	4.694	4.701	271.60 598,87	0,728 25,72	19

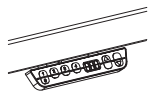
DV913 VIGO
DV911 NOTO
DV909 TOKIO
DV905 RYM
DV903 TAY
DV901 VERTIGO
DV902 PLANETA
DV914 DAKAR
DV910 OXFORD

ACCESSORI PER TAVOLI REGOLABILI IN ALTEZZA ACCESSORIES FOR DESK WITH HEIGHT ADJUSTMENT		CODICE CODE	PREZZO PRICE	Kg. lb	m ³ ft ³	n. no.
	Tastierino per regolazione altezza piano con memorie Control pad with memories for height adjustable worktop Unidad de control con memorias para regulación altura sobre de trabajo Clavier pour le réglage de la hauteur plateau avec mémoires de positions Tastatur zur Höhenverstellung mit Speicher Teclado com memória para regulação da altura do tampo	910.AC.T1.00	284	0,50 1,10	0,001 0,03	1 1

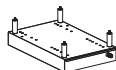
V04 cassetto drawer	WN
------------------------	----

ACCESSORI ACCESSORIES	L. W.	P. D.	H. H.	CODICE CODE	V04	Kg. lb	m ³ ft ³	n. no.
 Cassetto metallico sotto piano Under top metallic drawer Cajón metálico bajo sobre de trabajo Tiroir métallique inférieur Metallzarge Gaveta metálica sob o tampo	FO 32,5 12 7/8"	52,5 20 3/4"	7,2 2 7/8"	910.CA.01.04	166	4,00 8,82	0,012 0,42	1 1
 Cassetto metallico sotto piano (solo per tavoli scrivania regolabili in altezza) Under top metallic drawer (only for desk with height adjustment) Cajón metálico bajo sobre de trabajo (solo para mesa ajustables en altura) Tiroir métallique inférieur (uniquement pour table de bureau avec réglage en hauteur) Metallzarge (nur für Schreibtische mit Höheneinstellung) Gaveta metálica sob o tampo (só por mesa escritivaninha com regulagem de altura)	FO 32,5 12 7/8"	52,5 20 3/4"	14,5 5 3/4"	910.CA.01.05	199	4,30 9,48	0,013 0,45	2 2
 Cassetto metallico per mobile di servizio Metallic drawer for service unit Cajón metálico para mueble auxiliar Tiroir métallique pour desserte Metallzarge für Beistellmöbel gaveta metálica para móvel de serviço	FO 86 33 7/8"	31 12 1/4"	7 2 7/8"	910.CA.01.09	171	4,70 10,36	0,023 0,81	1 1

N.B.: Non è possibile posizionare il cassetto sottopiano sull'allungo collegato al contenitore multifunzione e alla scrivania / Note: It is not possible to place the drawer under the worktop on the extension side when it is connected to the multifunctional storage unit and the desk / N.B.: No es posible colocar el cajón debajo el sobre de trabajo de la ala auxiliar cuando está conectado al contenedor multifunción y a la mesa / N.B.: Il n'est pas possible de placer le tiroir sous plateau dans le retour si le retour est branché au rangement multifonctionnel et au bureau / NB: Metallzarge kann nicht unter der seitlichen Schreibtischplatte eingesetzt werden, wenn diese mit dem Multifunktionsschrank angeschlossen ist / N.B.: Não é possível posicionar a gaveta sob o tampo da extensão quando esta última está conectada ao armário multifunções e à secretária

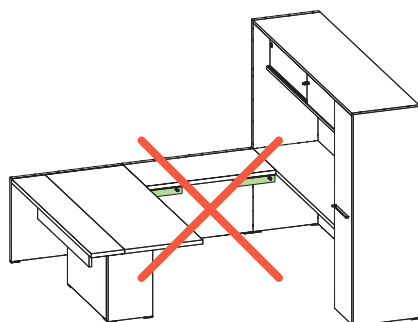

N.B.: Non è possibile abbinare il cassetto sottopiano ai tavoli sliding / Note: It is not possible to place the drawer under the worktop on the desk with sliding tops / N.B.: No es posible colocar el cajón debajo el sobre de trabajo de la mesa con sobres sliding / N.B.: Il n'est pas possible de placer le tiroir sous plateau dans le bureaux avec plateau coulissants / NB: Metallzarge kann nicht unter des Schreibtisches mit Arbeitsplatte "sliding top" / N.B.: Não é possível posicionar a gaveta sob o tampo da escritivaninha com planos sliding

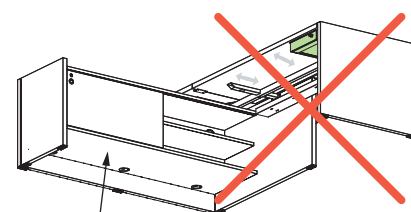

Cod. 910.TM.33.23
Cod. 910.TM.33.25

portacartelle draw-out frame	H
---------------------------------	---

ACCESSORI ACCESSORIES	L. W.	P. D.	H. H.	CODICE CODE	PREZZO PRICE	Kg. lb	m ³ ft ³	n. no.
 <p>Portacartelle estraibile per mobile di servizio Draw-out frame for service unit Portacarpetas extraíble para mueble auxiliar Porte-dossiers extractible pour desserte Ausziehbarer Hängeregister Rahmen für Beistellmöbel Dispositivo para pasta suspensa para móvel de serviço</p>	90 35 1/2"			910.CS.A5.08	148	1,00 2,20	0,033 1,16	1 1

box metallico metal box	H
----------------------------	---

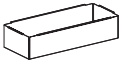
ACCESSORI ACCESSORIES	L. W.	P. D.	H. H.	CODICE CODE	PREZZO PRICE	Kg. lb	m ³ ft ³	n. no.
 <p>box (optional) per portacartelle estraibile per mobile di servizio art. 910.CS.A5.08 box (optional) for draw-out frame for service unit art. 910.CS.A6.08 box (opcional) para portacarpetas extraíble para mueble auxiliar art. 910.CS.A5.08 box (optional) pour Porte-dossiers extractible pour desserte Art. 910.CS.A5.08 Box (Option) für Ausziehbarer Hängeregister Rahmen für Beistellmöbel Art. 910.CS.A5.08 box (optional) para dispositivo para pasta suspensa para móvel de serviço Art. 910.CS.A5.08</p>	82 32 3/8"	34,5 13 5/8"	18 7 1/8"	910.CS.A6.08	100	4,10 9,04	0,013 0,45	1 1

DV913
VIGO

DV911
NOTO

DV909
TOKIO

DV905
RYM

DV903
TAY

DV901
VERTIGO

DV902
PLANETA

DV914
DAKAR

DV910
OXFORD

DV910 Oxford



All'interno dell'anta è posizionato uno specchio L=30 cm - 11 7/8" H=70 cm - 27 9/16"
 A mirror L=30 cm - 11 7/8" H=70 cm - 27 9/16" is positioned inside the hinged door
 En el interior de la puerta batiente se coloca un espejo L=30 cm - 11 7/8" H=70 cm - 27 9/16"
 Un miroir L = 30 cm - 11 7/8 "H = 70 cm - 27 9/16" est prévu à l'intérieur de la porte.
 Hinter der Tür befindet sich einen Spiegel L = 30 cm - 11 7/8 "H = 70 cm - 27 9/16"
 No interior da porta está posicionado um espelho L=30 cm - 11 7/8" H=70 cm - 27 9/16"

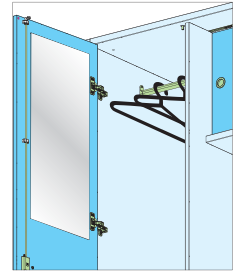

All'interno dell'anta è presente un tubo appendiabiti
 A clothes rail is placed in the inside of the door
 En el interno de la puerta se coloca un perchero
 Un tube porte-manteaux est fourni à l'intérieur de la penderie
 Hinter der Tür befindet sich ein Kleiderbügelrohr
 No interior do armário está posicionado um varão para cabides

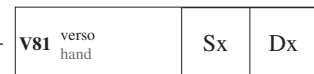
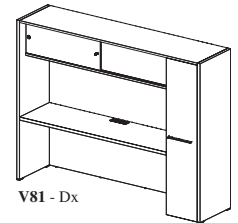
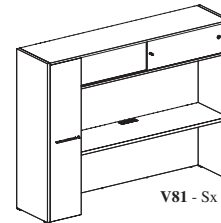
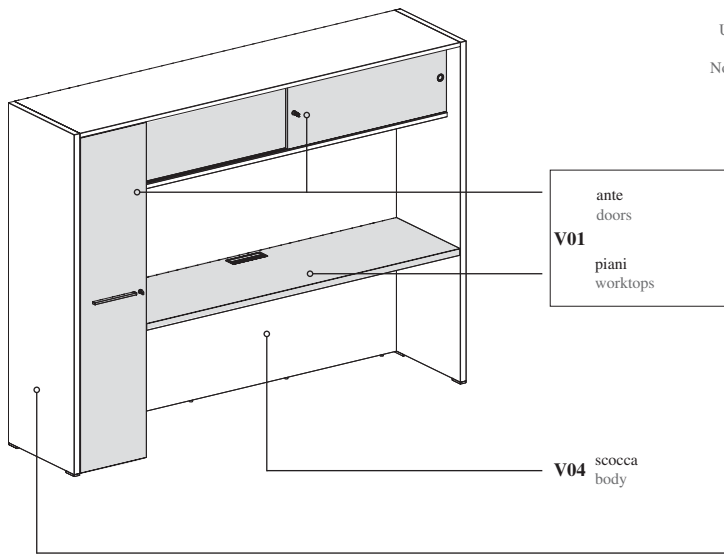

* Sotto i piani dei contenitori multifunzione è possibile integrare le cassettiere 910.EC.01._._ e 910.EC.02._._
 It is possible to integrate 910.EC.01._._ and 910.EC.02._._ pedestals under the worktops of the multi-purpose storage unit

maniglia di serie standard handle

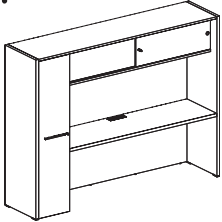

CONTENITORI MULTIUSO MULTIPURPOSE UNITS	L. W.	P. D.	H. H.	CODICE CODE	CATEGORIA PREZZO / PRICE CATEGORY		Kg. lb	m³ ft³	n. no.
					M1	M3			
* 	250 98 1/2"	60 23 5/8"	190 74 7/8"	910.HC.01.25	2.693	2.728	229,00 504,94	0,707 24,98	13 13
Contenitore multifunzione Multi-purpose storage unit Mueble multiuso Meuble multifonction Multifunktions-Möbel Armário multifuncional									

DV910 Oxford

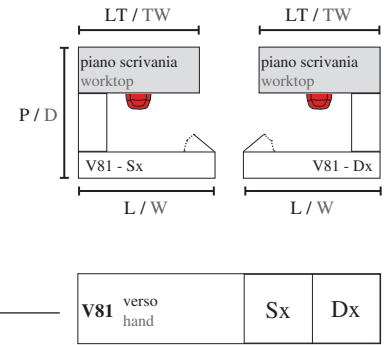
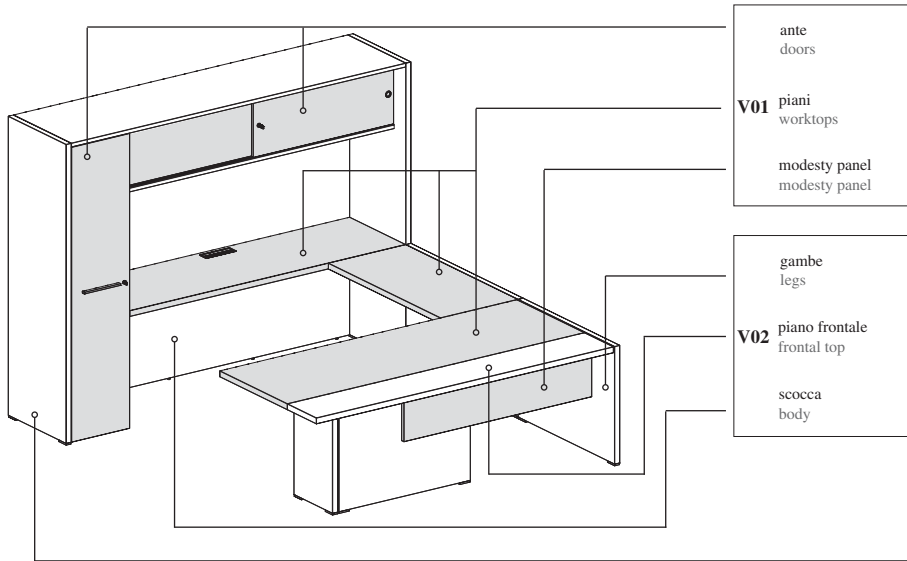
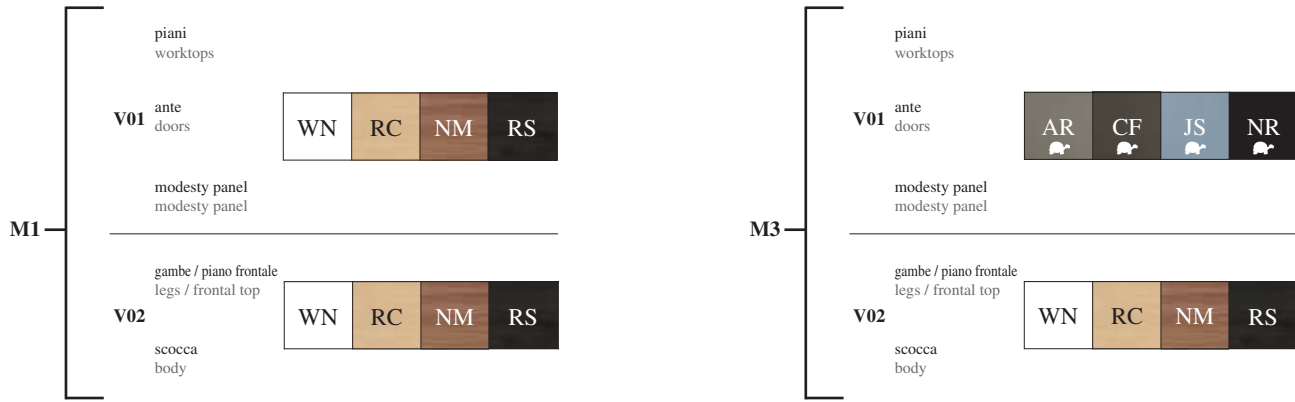

* Sotto i piani dei contenitori multifunzione è possibile integrare le cassettiere 910.EC.01._ _ e 910.EC.02._ _
It is possible to integrate 910.EC.01._ _ and 910.EC.02._ _ pedestals under the worktops of the multi-purpose storage unit

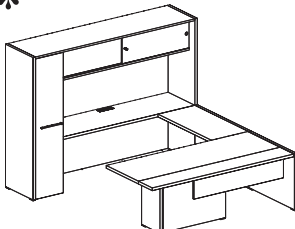

COMPOSIZIONI COMPOSITIONS	LT TW	L. W.	P. D.	H. H.	CODICE CODE	CATEGORIA PREZZO / PRICE CATEGORY		Kg. lb	m ³ ft ³	n. no.
						M1	M3			
* 	200 78 3/4"	250 98 1/2"	276 108 3/4"	190 74 7/8"	910.CM.P2.20	4.196	4.250	376,50 830,18	1,041 36,78	25 25
	220 86 5/8"	250 98 1/2"	276 108 3/4"	190 74 7/8"	910.CM.P2.22	4.304	4.349	382,50 843,41	1,051 37,13	25 25

Composizione con piano composto e contenitore multifunzione
Composition with composed worktop and multi-purpose storage unit
Composición con sobre de trabajo compuesto y mueble multiuso
Composition avec plateau composé et meuble multifonction
Komposition mit mehrteiliger Tischplatte und Multifunktions-Möbel
Composição com tampo composto e armário multifuncional

DV910 VIGO
DV911 NOTO
DV909 TOKIO
DV905 RYM
DV903 TAY
DV901 VERTIGO
DV902 PLANETA
DV914 DAKAR
DV910 OXFORD

maniglia di serie
standard handle



* Sotto i piani dei contenitori multifunzione è possibile integrare le cassetiere 910.EC.01._ e 910.EC.02._
It is possible to integrate 910.EC.01._ and 910.EC.02._ pedestals under the worktops of the multi-purpose storage unit

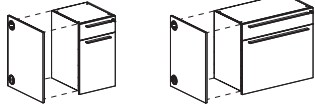
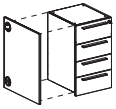

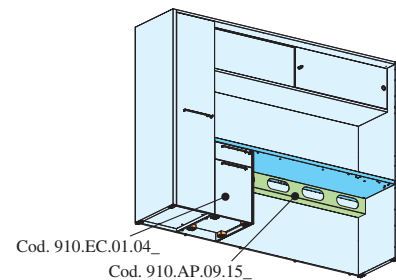
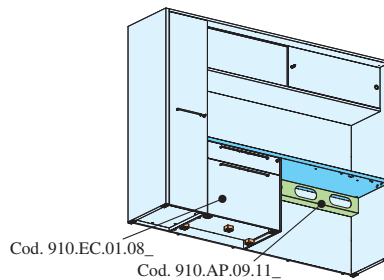
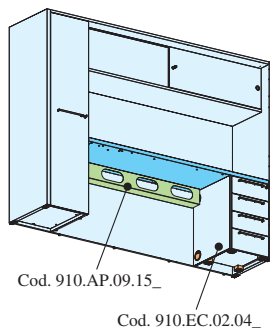
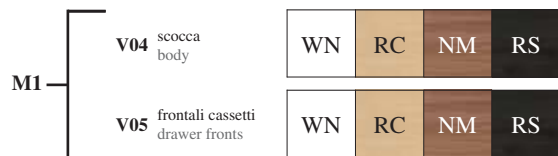

CASSETTIERE PER CONTENITORI PEDESTALS FOR STORAGE UNITS	L. W.	P. D.	H. H.	CODICE CODE	CATEGORIA PREZZO / PRICE CATEGORY		Kg. lb	m ³ ft ³	n. no.
					M1	M3			
*  L. 43,5 cm - W. 17 1/4" L. 82 cm - W. 32 3/8" Cassetiera portante 2 cassetti, di cui uno classificatore, da utilizzare sui contenitori multifunzione Drawers + file carrying pedestal, to be used on multi-purpose storage unit Cajonera portante 2 cajones, uno archivador, para mueble multiuso Caisson-porteur 2 tiroirs + classificateur, à utiliser sur meuble multifonction Schubkastenblock mit 2 Schüben, davon eine für Hängeregister, für Multifunktions-Möbel Gaveteiro volante 2 gavetas, sendo 1 gavetão, para ser utilizado no armário multifuncional	43,5 17 1/4"	58 22 7/8"	71 28"	910.EC.01.04	481	486	32,50 71,66	0,196 6,92	6 6
	82 32 3/8"	58 22 7/8"	71 28"	910.EC.01.08	591	597	46,00 101,43	0,318 11,23	6 6
*  Cassetiera portante 4 cassetti, da utilizzare sui contenitori multifunzione 4 drawers carrying pedestal, to be used on multi-purpose storage unit Cajonera portante 4 cajones, para mueble multiuso Caisson-porteur 4 tiroirs à utiliser sur meuble multifonction Schubkastenblock mit 4 Schüben, für Multifunktions-Möbel Gaveteiro pedestal 4 gavetas, para ser utilizado no armário multifuncional	43,5 17 1/4"	58 22 7/8"	71 28"	910.EC.02.04	507	509	32,82 25,35	0,200 1,20	8 8



maniglia di serie standard handle

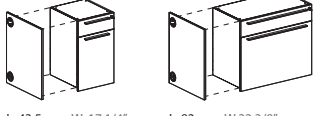

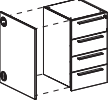
* Sotto i piani in allungo delle composizioni con il mobile multifunzione è possibile integrare le cassettiere 910.EC.03._ e 910.EC.04._
It is possible to integrate 910.EC.03._ and 910.EC.04._ pedestals under the worktops of the extension tables

CASSETTIERE PER ALLUNGI PEDESTALS FOR EXTENSION TABLES	L. W.	P. D.	H. H.	CODICE CODE	CATEGORIA PREZZO / PRICE CATEGORY		Kg. lb	m ³ ft ³	n. no.	
					M1	M3				
*  L. 43,5 cm - W. 17 1/4" L. 82 cm - W. 32 3/8"		43,5 17 1/4"	56 22 1/8"	71 28"	910.EC.03.04	481	486	32,50 71,66	0,196 6,92	6 6
						591	597			
Cassettiera portante 2 cassetti, di cui uno classificatore, da utilizzare sugli allunghi laterali Carrying 2 drawers pedestals for extension tables Cajonera portante 2 cajones, uno archivador, para mesa alargó lateral Caisson-porteur 2 tiroirs + classificateur, à utiliser sur retour latéral Schubkastenblock mit 2 Schüben, davon eine für Hängeregister, für Beistelltisch Gaveteiro pedestal 2 gavetas, sendo 1 gavetão, para ser utilizado no complemento lateral										
* 		43,5 17 1/4"	56 22 1/8"	71 28"	910.EC.04.04	507	509	32,82 25,35	0,200 1,20	8 8
Cassettiera portante 4 cassetti, da utilizzare sugli allunghi laterali 4 drawers carrying pedestal, to be used on extension tables Cajonera portante 4 cajones para mesa alargó lateral Caisson-porteur 4 tiroirs à utiliser sur retour latéral Schubkastenblock mit 4 Schüben, für Beistelltische Gaveteiro pedestal 4 gavetas, para ser utilizado no complemento lateral										

M1	V04 scocca body	WN	RC	NM	RS
	V05 frontali cassetti drawer fronts	WN	RC	NM	RS

M3	V04 scocca body	WN	RC	NM	RS
	V05 frontali cassetti drawer fronts	AR	CF	JS	NR

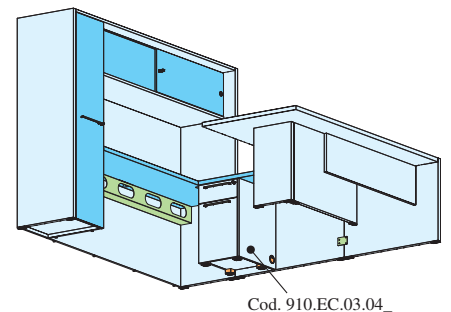
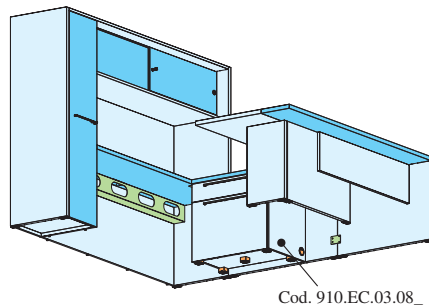
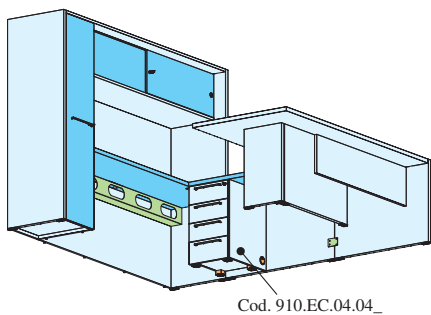

DV913 VIGO
DV911 NOTO
DV909 TOKIO
DV905 RYM
DV903 TAY
DV901 VERTIGO
DV902 PLANETA
DV914 DAKAR
DV910 OXFORD

V06	schiena back panel	9109	9110	9804	9806

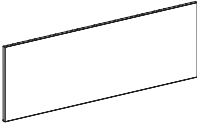
SCHIENA PER CONTENITORE BACK PANEL FOR UNITS	L. W.	P. D.	H. H.	CODICE CODE	V06		Kg. lb	m ³ ft ³	n. no.
 <p>Schiena pinnabile per mobile multifunzione</p> <p>Pinnable back panel for multi-purpose storage unit</p> <p>Trasera pinnabile para mueble multiuso</p> <p>Dos pinnable pour meuble multifonction</p> <p>Pinnable Rückwand für Multifunktions-Möbel</p> <p>Fundo "pinnable" para armário multifuncional</p>	200 78 3/4"	2,5 1"	69,5 27 3/8"	910.AC.SC.20	299		6,00 13,23	0,055 1,94	1 1

V19	alimentazione power	EU socket	UK socket	US socket

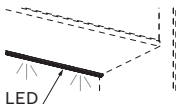
ACCESSORI ACCESSORIES	L. W.	P. D.	H. H.	CODICE CODE	V19		Kg. lb	m ³ ft ³	n. no.
 <p>Barra led (optional) per contenitore multifunzione</p> <p>LED spotlight (optional) for multi-purpose storage unit</p> <p>Luz LED (opcional) para mueble multiuso</p> <p>Spot LED (en option) pour meuble multifonction</p> <p>LED Stange (Option) für Multifunktions-Möbel</p> <p>Barra de led (opcional) para armário multifuncional</p>	200 78 3/4"	3 1 1/4"	1,5 5/8"	910.LL.02.20	EU socket	242	6,50 14,33	0,018 0,63	2 2
					UK socket	242			
					US socket	220			

M1	V01 piano worktop	WN	RC	NM	RS
	V02 gambe legs	WN	RC	NM	RS

M3	V01 piano worktop	AR	CF	JS	NR
	V02 gambe legs	WN	RC	NM	RS

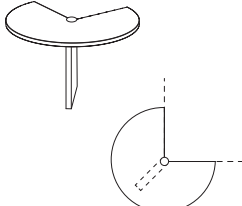
PENISOLA END UNIT	L. W.	P. D.	H. H.	CODICE CODE	CATEGORIA PREZZO / PRICE CATEGORY		Kg. lb	m ³ ft ³	n. no.
					M1	M3			
 <p>Penisola con gamba</p> <p>End meeting element with leg</p> <p>Península con pata</p> <p>Élément terminal avec piétement</p> <p>Halbinsel mit Fuß</p> <p>Tampo peninsular com pé</p>	120 47 1/4"	120 47 1/4"	75 29 5/8"	910.PE.01.12	582	600	35,00 77,17	0,104 3,67	5 5

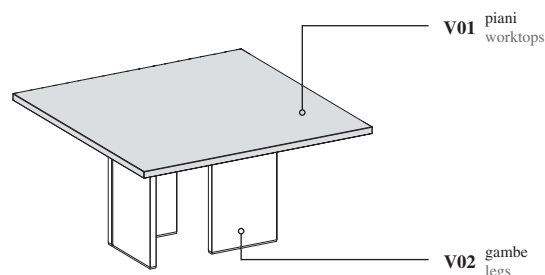
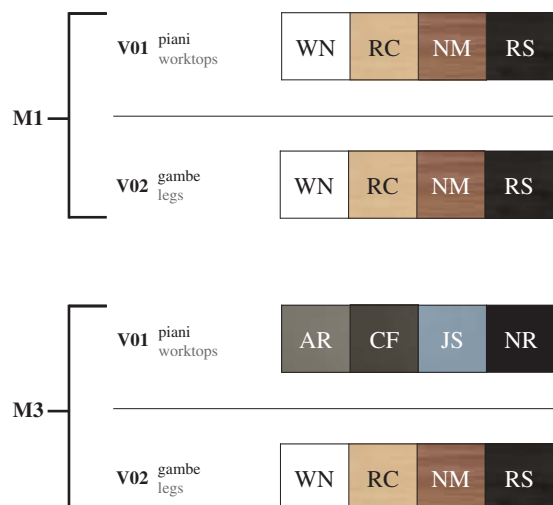

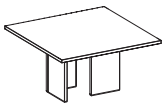
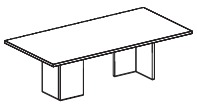
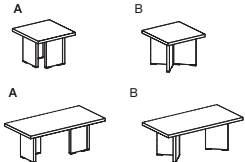

TAVOLI RIUNIONI / TAVOLI CAFFÉ MEETING TABLES / COFFEE TABLES	L. W.	P. D.	H. H.	CODICE CODE	CATEGORIA PREZZO / PRICE CATEGORY		Kg. lb	m ³ ft ³	n. no.			
					M1	M3						
 <p>Tavolo riunioni quadrato Square meeting table Mesa de reunión cuadrada Table de réunion carrée Besprechungstisch, quadratisch Mesa reunião quadrada</p>	140 55 1/8"	140 55 1/8"	75 29 3/8"	910.TR.38.14	897	982	89,00 196,24	0,199 7,03	3 3			
 <p>Tavolo riunioni rettangolare Rectangular meeting table Mesa de reunión rectangular Table de réunion rectangulaire Besprechungstisch, rechteckig Mesa reunião retangular</p>	240 94 1/2"	120 47 1/4"	75 29 3/8"	910.TR.41.24	1.093	1.128	111,00 244,75	0,250 8,83	3 3			
 <p>tavolino caffè con gambe pannellate coffee table with panelled legs mesa de café con patas paneladas table basse pieds panneau Beistelltisch mit Wangenfuss mesinha de café com pernas em painel</p>	60 23 5/8"	60 23 5/8"	45 17 3/4"	910.TT.03.06	311	313	24,00 52,92	0,047 1,66	2 2			
	120 47 1/4"	60 23 5/8"	45 17 3/4"	910.TT.03.12	361	369	34,00 74,97	0,067 2,36	2 2			
					<table border="1"> <tr> <td>A</td> <td>B</td> </tr> <tr> <td>Con gambe a "L" With "L" shaped legs Con patas a "L" Avec pied en forme de "L" Mit "L" Wangen Füße Com perna em "L"</td> <td>Con gambe a "V" With "V" shaped legs Con patas a "V" Avec pied en forme de "V" Mit "V" Wangen Füße Com perna em "V"</td> </tr> </table>	A	B	Con gambe a "L" With "L" shaped legs Con patas a "L" Avec pied en forme de "L" Mit "L" Wangen Füße Com perna em "L"	Con gambe a "V" With "V" shaped legs Con patas a "V" Avec pied en forme de "V" Mit "V" Wangen Füße Com perna em "V"			
A	B											
Con gambe a "L" With "L" shaped legs Con patas a "L" Avec pied en forme de "L" Mit "L" Wangen Füße Com perna em "L"	Con gambe a "V" With "V" shaped legs Con patas a "V" Avec pied en forme de "V" Mit "V" Wangen Füße Com perna em "V"											

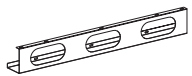
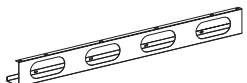
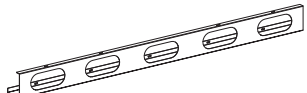
DV913 VIGO
DV911 NOTO
DV909 TOKIO
DV905 RYM
DV903 TAY
DV901 VERTIGO
DV902 PLANETA
DV914 DAKAR
DV910 OXFORD

CANALIZZAZIONE WIRE MANAGEMENT		L. W.	P. D.	H. H.	CODICE CODE	PREZZO PRICE	Kg. lb	m ³ ft ³	n. no.
	canalina per contenitori multifunzione L.116,5	116,5 45 7/8"	12 4 3/4"	15 6"	910.AP.09.11	88	4,00 8,82	0,025 0,88	1 1
	cable channel for multi-purpose storage unit L.116,5								
	canal pasacables para mueble multiuso L. 116,5								
	Goulotte pour meuble multifonction L. 116,5								
	Kabelkanal für Multifunktions-Möbel L.116,5								
calha para armário multifuncional L.116,5									
	canalina per contenitori multifunzione L.155	155 61 1/8"	12 4 3/4"	15 6"	910.AP.09.15	109	5,00 11,02	0,033 1,16	1 1
	cable channel for multi-purpose storage unit L.155								
	canal pasacables para mueble multiuso L. 155								
	Goulotte pour meuble multifonction L. 155								
	Kabelkanal für Multifunktions-Möbel L.155								
calha para armário multifuncional L.155									
	canalina per contenitori multifunzione L.199	199 78 3/8"	12 4 3/4"	15 6"	910.AP.09.19	124	6,50 14,33	0,040 1,41	1 1
	cable channel for multi-purpose storage unit L.199								
	canal pasacables para mueble multiuso L. 199								
	Goulotte pour meuble multifonction L. 199								
	Kabelkanal für Multifunktions-Möbel L.199								
calha para armário multifuncional L.199									

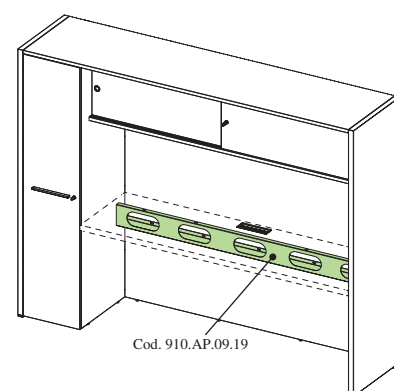
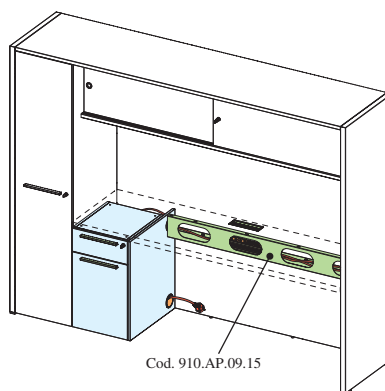
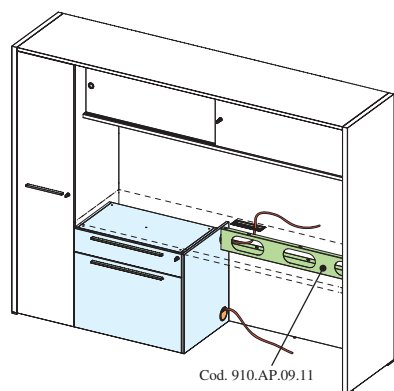
ESEMPI DI CANALIZZAZIONE SU CONTENITORI MULTIFUNZIONE
 EXAMPLES OF CABLE MANAGEMENT FOR MULTIFUNCTIONAL STORAGE UNIT
 EJEMPLOS DE CANALIZACIÓN DEL CONTENEDOR MULTIFUNCIÓN
 EXEMPLES DE CANALISATION RANGEMENT MULTIFONCTIONNEL
 BEISPIELE VON VERKABELUNG BEI MULTIFUNKTIONSSCHRANK
 EXEMPLOS DE CANAIS PASSA-CABOS NOS ARMÁRIOS MULTIFUNÇÕES

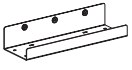

CANALIZZAZIONE WIRE MANAGEMENT		L. W.	P. D.	H. H.	CODICE CODE	PREZZO PRICE	Kg. lb	m ³ ft ³	n. no.
 <p>canalina in lamiera per salita verticale</p> <p>vertical cable channel made of sheet metal</p> <p>canal pasacable vertical en chapa</p> <p>goulotte en tôle d'acier verticale</p> <p>Senkrechter Metall Kabelkanal</p> <p>Calha em chapa de aço para subida de cabos</p>			58 22 7/8"	910.AP.08.06	47	1,00 2,20	0,003 0,10	1 1	
 <p>Catena passacavi per tavoli con regolazione elettrica in altezza</p> <p>Cable management chain for desks with electric height adjustment</p> <p>Cadena de gestión de cables para mesas con ajuste de altura eléctrico</p> <p>Chaîne de gestion des câbles pour bureaux avec réglage hauteur électrique</p> <p>Kabelführungskette für Tische mit elektrischer Höheneinstellung</p> <p>Cadeia de gerenciamento de cabos para mesas com regulação eléctrica em altura</p>			130 51 1/4"	910.AP.10.00	100	0,50 1,10	0,007 0,24	1 1	
 <p>Vassoio (optional) per mobile di servizio</p> <p>Tray (optional) for service unit</p> <p>Bandeja (opcional) para mueble auxiliar</p> <p>Plateau de service (en option) pour desserte</p> <p>Servicewanne (optional) für Beistellmöbel</p> <p>Tabuleiro (optional) para móvel de serviço</p>	32 12 5/8"	10 4"		910.AP.33.03	38	1,00 2,20	0,003 0,10	1 1	

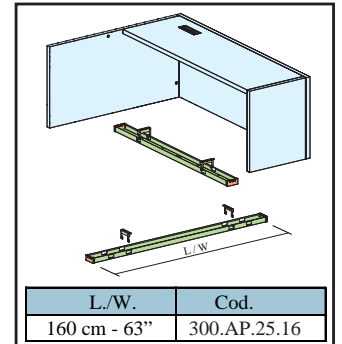
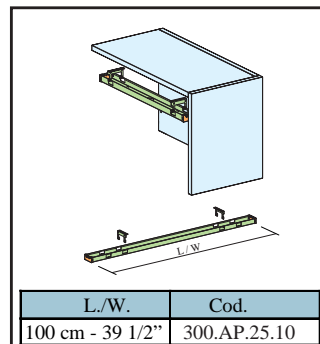
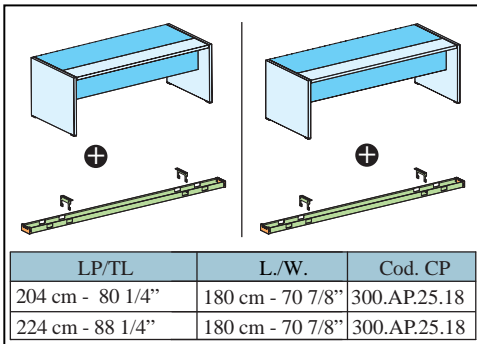

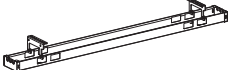
CANALIZZAZIONE WIRE MANAGEMENT		LP TL	L. W.	P. D.	H. H.	CODICE CODE	V04	Kg. lb	m ³ ft ³	n. no.
 <p>canale passacavi singolo per tavoli</p> <p>single cable channel for desks</p> <p>canal pasacables individual para mesas</p> <p>goulotte simple pour bureaux</p> <p>einzelner Kabelkanal für Schreibtische</p> <p>canal passa-cabos único para mesas</p>		120 47 1/4"	100 39 3/8"	10,2 4 1/8"	11,4 4 1/2"	300.AP.25.10	54	1,90 4,18	0,006 0,21	1 1
		184 72 1/2"	160 63"	10,2 4 1/8"	11,4 4 1/2"	300.AP.25.16	64	2,50 5,51	0,010 0,35	1 1
		204 80 1/4"	180 70 7/8"	10,2 4 1/8"	11,4 4 1/2"	300.AP.25.18	67	2,80 6,17	0,012 0,42	1 1
		224 88 1/4"	180 70 7/8"	10,2 4 1/8"	11,4 4 1/2"	300.AP.25.18	67	2,80 6,17	0,012 0,42	1 1
						<div style="border: 1px solid black; padding: 5px;"> <p>vedi note tecniche see technical notes ver manual técnico voir notes techniques siehe Technikanmerkungen ver notas técnicas</p> </div>				

DV913 VIGO
DV911 NOTO
DV909 TOKIO
DV905 RYM
DV903 TAY
DV901 VERTIGO
DV902 PLANETA
DV914 DAKAR
DV910 OXFORD

V81 verso hand	Sx	Dx
-----------------------	----	----

CANALIZZAZIONE WIRE MANAGEMENT	L. W.	P. D.	H. H.	CODICE CODE	V81	Kg. lb	m ³ ft ³	n. no.
canalina in lamiera per scrivanie L.200 cable channel made of sheet metal for desks L.200 canal pasacable en chapa para mesas L.200 goulotte en tôle d'acier pour les bureaux L.200 Metall Kabelwanne für Schreibtisch L. 200 Calha em chapa de aço para escrivanía L.200	165 65"			910.AP.01.16	74	4,50 9,92	0,015 0,53	1 1
canalina in lamiera per scrivanie L.220 cable channel made of sheet metal for desks L.220 canal pasacable en chapa para mesas L.220 goulotte en tôle d'acier pour les bureaux L.220 Metall Kabelwanne für Schreibtisch L. 220 Calha em chapa de aço para escrivanía L.220	185 72 7/8"			910.AP.01.18	86	5,00 11,02	0,017 0,60	1 1



Le composizioni possono essere completate con le canaline (optional), come da schema

Compositions can be completed with wire management (optional), as shown
 Las composiciones se pueden completar con canaleta pasacabos (opcional), como se muestra
 Les compositions peuvent être complétées de goulotte (en option), comme le montre le schéma
 Die Kompositionen können mit Kabelkanal (optional) vervollständigt werden, wie unten schematisch dargestellt wird
 As composições podem ser completadas com as canais passa-cabos (opcional), conforme esquema

910.TS.59.

Dx/R

+

Cod. 910.AP.01. Dx/R

Sx/L

+

od. 910.AP.01. Sx/L

L/WC	P	Cod. CP
200 cm - 78 3/4"	150 cm - 59 1/16"	910.AP.01.16
220 cm - 86 5/8"	170 cm - 67"	910.AP.01.18

910.TM.32.

Dx/R

+

Cod. 910.AP.01. Sx/L

Sx/L

+

od. 910.AP.01. Dx/R

L/WC	P	Cod. CP
200 cm - 78 3/4"	150 cm - 59 1/16"	910.AP.01.16
220 cm - 86 5/8"	170 cm - 67"	910.AP.01.18

910.TM.33.

Dx/R

+

Cod. 910.AP.01. Sx/L

Sx/L

+

od. 910.AP.01. Dx/R

L/WC	P	Cod. CP
200 cm - 78 3/4"	150 cm - 59 1/16"	910.AP.01.16
220 cm - 86 5/8"	170 cm - 67"	910.AP.01.18

910.TM.42.

Dx/R

+

Cod. 910.AP.01. Sx/L

Sx/L

+

od. 910.AP.01. Dx/R

L/WC	P	Cod. CP
200 cm - 78 3/4"	150 cm - 59 1/16"	910.AP.01.16
220 cm - 86 5/8"	170 cm - 67"	910.AP.01.18

910.TM.47.

Dx/R

+

Cod. 910.AP.01. Dx/R

Sx/L

+

od. 910.AP.01. Sx/L

L/WC	P	Cod. CP
200 cm - 78 3/4"	150 cm - 59 1/16"	910.AP.01.16
220 cm - 86 5/8"	170 cm - 67"	910.AP.01.18



N.B.: Fare attenzione al verso delle canaline da ordinare
 Note: Please pay attention to the direction of the wire management
 N.B.: Para la aplicación hay que averiguar a la dirección de la canalización
 N.B.: Pour l'application faire attention à la direction de goulotte
 N.B.: Für die Montage beachten Sie bitte die Richtung der Kabelkanal
 Nota: Para a instalação, preste atenção na direção da canalização