

# Planeta

DV902



## **LINEA DIREZIONALE**

EXECUTIVE LINE

SERIE EJECUTIVA

LIGNES DE DIRECTION

DIREKTIONSEINRICHTUNGSPROGRAMME

LINHA DIRECÇÃO

DV913  
VIGO

DV911  
NOTO

DV909  
TOKIO

DV905  
RYM

DV903  
TAY

DV901  
VERTIGO

DV902  
PLANETA

 **con serratura**  
with lock  
con cerradura  
avec serrure  
mit Schloss  
com fechadura

---

 **articolo non in pronta consegna. Per la disponibilità contattare l'ufficio commerciale**  
item not in prompt delivery. Please contact the commercial department for checking availability  
producto no disponible en stock. Para la disponibilidad contactar con el departamento comercial  
article non disponible en stock. Merci de contacter le service commercial pour vérifier la disponibilité  
Dieses Produkt ist nicht sofort lieferbar. Setzen Sie sich mit unserem Handelsbüro in Verbindung für die Warenverfügbarkeit  
produtos não pronta entrega. Acerca da disponibilidade, contactar o sector comercial

---

**T** **vetro temperato**  
tempered glass  
cristal templado  
verre trempé  
Gehärtetes glas  
vidro temperado

---

 **fino ad esaurimento**  
until exhaustion  
hasta que se agoten  
soumises à disponibilité  
bis Erschöpfung  
até à exaustão

---

**Σ** **articolo completo di tappi passacavi per il passaggio dei cablaggi**  
item provided with outlet lids for the cable management  
artículo completo de tapones pasacables aplicados al panel interior  
article équipé d'obturateurs pour le passage des câbles  
der artikel hat abdeckungen für den kabelausgang  
artigo completo com tampas passa-cabos para passagem de ação

---

**V01 M1 Piani di lavoro in melaminico sp. 18 mm**  
 Melamine worktops 18 mm thick  
 Sobres de trabajo en melamina 18 mm de grosor  
 Plans de travail en melaminé ép. 18 mm  
 Tischplatten aus Melamin St. 18 mm  
 Planos de trabalho em melaminico esp. 18 mm



**RC**  
 Rovere chiaro  
 Light oak  
 Roble claro  
 Chêne clair  
 Eiche hell  
 Carvalho claro



**NM**  
 Noce "Maroncelli"  
 Walnut "Maroncelli"  
 Nogal "Maroncelli"  
 Noyer "Maroncelli"  
 Nussbaum "Maroncelli"  
 Nogueira "Maroncelli"

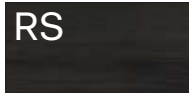

**RS**  
 Rovere scuro  
 Dark oak  
 Roble oscuro  
 Chêne foncé  
 Eiche dunkel  
 Carvalho escuro

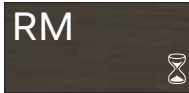

**RM**  
 Rovere moro  
 Dark oak  
 Roble oscuro  
 Chêne foncé  
 Eiche dunkel  
 Carvalho escuro



**RT**  
 Rovere tabacco  
 Tobacco oak  
 Roble tabaco  
 Chêne tabac  
 Eiche tabak  
 Carvalho tabacco

**V01 M2 Piani di lavoro in melaminico sp. 18 mm**  
 Melamine worktops 18 mm thick  
 Sobres de trabajo en melamina 18 mm de grosor  
 Plans de travail en melaminé ép. 18 mm  
 Tischplatten aus Melamin St. 18 mm  
 Planos de trabalho em melaminico esp. 18 mm



**NO**  
 Nero opaco  
 Matt black  
 Negro mate  
 Noir mat  
 Schwarz matt  
 Preto opaco

**V01 L Piani di lavoro in laminato sp. 18 mm**  
 Laminate work tops 18 mm  
 Sobres de trabajo en laminado 18 mm de grosor  
 Plateaux en laminé ép. 18 mm  
 Tischplatten aus Laminat St. 18 mm  
 Plano de trabalho em laminado de espessura de 18 mm



**WL**  
 Bianco lucido  
 Polished white  
 Blanco brillo  
 Blanc luisant  
 Weiß hochglanz  
 Branco brilhante

**V01 VW Piani di lavoro in vetro temperato retrolaccato sp. 10 mm**  
 Rear-lacquered gloss tempered tops 10 mm thick  
 Sobre de trabajo en cristal retrolacado y templado 10 mm de grosor  
 Plans de travail en verre retro-lacqué trempé ép. 10 mm  
 Rückseite lackiertem Ätzglas/Cristal aus Sicherheitsglas St. 10 mm  
 Plano de trabalho em vidro temperado espessura de 10 mm



**VW**  
 Bianco  
 White  
 Blanco  
 Blanc  
 Weiss  
 Branco

**V01 VAN Piani di lavoro in vetro temperato retrolaccato acidato sp. 10 mm**  
 Worktops rear-lacquered acetated tempered tops 10 mm thick  
 Sobre de trabajo en cristal retrolacado y ácido templado 10 mm de grosor  
 Plans de travail en verre retro-lacqué acide trempé ép. 10 mm  
 Tischplatte auslackiertem Ätzglas Crista aus Sicherheitsglas St. 10 mm  
 Plano de trabalho em vidro fosco temperado espessura de 10 mm



**VAN**  
 Nero  
 Black  
 Negro  
 Noir  
 Schwarz  
 Preto

**V01 C Piani di lavoro in cuoio con cuciture sp. 20 mm**  
 Worktops in leather with stitches, 20 mm thick  
 Sobre en cuero cosido de 20 mm de grosor/espesor  
 Plateaux en cuir avec coutures, 20 mm épaisseur  
 Leder Tischplatten mit Nähten, 20 mm Stärke  
 Plano de trabalho revestido com couro natural com costuras espessura 20 mm

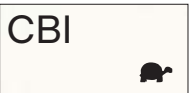

**CBI**  
 Cuoio bianco  
 White hard leather  
 Cuero blanco  
 Cuir blanc  
 Weiß Leder  
 Couro branco



**CNE**  
 Cuoio nero  
 Black hard leather  
 Cuero negro  
 Cuir noir  
 Schwarz Leder  
 Couro preto



**CTM**  
 Cuoio testa di moro  
 Dark brown hard leather  
 Cuero marrón oscuro  
 Cuir marron foncé  
 Leder Dunkelbraun  
 Couro castanho escuro

**V01 GRES Piano scrivania in vetro temprato trasparente sp. 8 mm, accoppiato con piano in gres porcellanato sp. 6 mm**  
 Desktop in 8 mm thick transparent tempered glass, matched with a 6 mm thick porcelain stoneware top  
 Encimera de cristal templado transparente de 8 mm de grosor, unida a una tapa de gres porcelánico de 6 mm de grosor  
 Plan de travail en verre trempé transparent de 8 mm d'ép., assorti d'un plateau en grès porcelaine de 6 mm d'ép.  
 Arbeitsplatte aus 8 mm dickem, transparentem, gehärtetem Glas in Kombination mit einer 6 mm dicken Platte aus Feinsteinzeug  
 Tampo de trabalho em vidro transparente temperado de 8 mm de espessura, combinado com uma placa de grés porcelânico de 6 mm de espessura



**VGB**  
 Bianco "Extra White"  
 White "Extra White"  
 Blanco "Extra White"  
 Blanc "Extra White"  
 Weiß "Extra White"  
 Branco "Extra White"



**VGN**  
 Nero "Marquina"  
 Black "Marquina"  
 Negro "Marquina"  
 Noir "Marquina"  
 Schwarz "Marquina"  
 Preto "Marquina"

DV913 VIGO  
 DV911 NOTO  
 DV909 TOKIO  
 DV905 RYM  
 DV903 TAY  
 DV901 VERTIGO  
 DV902 PLANETA

# DV902 Planeta

Finiture - finishes - acabados - finitions - farben - acabamentos

**V02** **Strutture metalliche**  
 Metal structures  
 Estructuras metálicas  
 Structures métalliques  
 Metallstrukturen  
 Estruturas metálicas



**Bianco**  
 White  
 Blanco  
 Blanc  
 Weiss  
 Branco

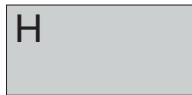

**Alluminio**  
 Aluminium  
 Aluminio  
 Aluminium  
 Aluminium  
 Aluminio



**Antracite**  
 Anthracite  
 Antracita  
 Anthracite  
 Anthrazit  
 Antracite

**V13** **Top access Alluminio**  
 Top access Aluminium  
 Top access Aluminio  
 Top access Aluminium  
 Top Access Aluminium  
 Top access Aluminio



**Bianco**  
 White  
 Blanco  
 Blanc  
 Weiss  
 Branco



**Alluminio**  
 Aluminium  
 Aluminio  
 Aluminium  
 Aluminium  
 Aluminio



**Nero anodizzato**  
 Anodized black  
 Negro anodizado  
 Noir anodisé  
 eloxiert Schwarz  
 Preto anodizado

**V02** **Struttura metallica (gambone in metallo con base)**  
 Metallic structure (metal column base)  
 Estructura metálica (pata cilíndrica de metal)  
 Structure métallique (pied-colonne en métal avec base)  
 Metall struktur (Metallsäule mit Säulenfuß)  
 Estrutura metálica (pedestal em metal cor com base)

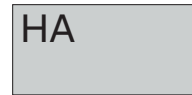

**Alluminio "anodizzato"**  
 "anodized" aluminium  
 aluminio "anodizado"  
 aluminium "anodisé"  
 "eloxiert" Aluminium  
 alumínio "anodizado"



gambone alluminio / basamento inox  
 aluminium column / stainless steel base

**Top access mobili di servizio (solo in colore alluminio)**  
 Top access Aluminium (only in aluminum colour)  
 Top access Aluminio (solo en color aluminio)  
 Top access Aluminium (uniquement en couleur aluminium)  
 Top Access Aluminium (nur in Aluminium)  
 Top access Aluminio (somente na cor alumínio)



**Alluminio**  
 Aluminium  
 Aluminio  
 Aluminium  
 Aluminium  
 Aluminio

V09	<b>Modesty panel</b> Modesty panel Faldón Voile de fond Knieblende Modesty panel				
	<b>M1</b>	<b>WN</b>	<b>HH</b>	<b>RC</b>	<b>NM</b>
	Melaminico sp. 18 mm Melamine 18 mm thick Melamina 18 mm de grosor Melaminé ép. 18 Mm épaisseur Melamin st. 18 Mm Melamínico esp. 18 Mm	Bianco White Blanco Blanc Weiss Branco	Alluminio Aluminium Aluminio Aluminium Aluminium Aluminio	Rovere chiaro Light oak Roble claro Chêne clair Eiche hell Carvalho claro	Noce "Maroncelli" Walnut "Maroncelli" Nogal "Maroncelli" Noyer "Maroncelli" Nussbaum "Maroncelli" Nogueira "Maroncelli"
		<b>RS</b>	<b>RM</b>	<b>RT</b>	
		Rovere scuro Dark oak Roble oscuro Chêne foncé Eiche dunkel Carvalho escuro	Rovere moro Dark oak Roble oscuro Chêne foncé Eiche dunkel Carvalho escuro	Rovere tabacco Tobacco Oak Roble tabaco Chêne tabac Eiche tabak Carvalho tabaco	
	<b>M2</b>	<b>NO</b>		<b>L</b>	<b>WL</b>
	Melaminico sp. 18/25 mm Melamine 18/25 mm thick Melamina 18/25 mm de grosor Melaminé ép. 18/25 mm Melamin st. 18/25 mm Melamínico esp. 18/25 mm	Nero opaco Matt black Negro mate Noir mat Schwarz matt Preto opaco		Laminato sp. 18 mm Laminate 18 mm thick Laminado 18 mm de grosor Laminé ép. 18 mm Laminat st. 18 mm Laminado de espessura de 18 mm	Bianco lucido Polished white Blanco brillo Blanc luisant Weiß hochglanz Branco brilhante
	<b>C</b>	<b>CBI</b>	<b>CNE</b>	<b>CTM</b>	
	Cuoio con cuciture sp. 20 mm Leather with stitches, 20 mm thick Cuero cosido de 20 mm de grosor Cuir avec coutures, ép. 20 mm Leder mit Nähten, 20 mm Stärke Couro com costuras esp. 20 mm	Cuoio bianco White hard leather Cuero blanco Cuir blanc Weiß Leder Couro branco	Cuoio nero Black hard leather Cuero negro Cuir noir Schwarz Leder Couro preto	Cuoio testa di moro Dark brown hard leather Cuero marrón oscuro Cuir marron foncé Leder Dunkelbraun Couro castanho escuro	

DV913  
VIGO

DV911  
NOTO

DV909  
TOKIO

DV905  
RYM

DV903  
TAY

DV901  
VERTIGO

DV902  
PLANETA

# DV902 Planeta

## Finiture - finishes - acabados - finitions - farben - acabamentos

**V04** **Mobile di servizio / cassettiera per vano interno mobile di servizio e ripiano**  
 Service unit / pedestal for inside service unit and shelf  
 Mueble auxiliar / cajonera para hueco interior meuble auxiliar y balda  
 Desserte / caisson pour compartiment intérieur desserte et tablette  
 Beistellschrank / Schubladenelement für internes Beistellmöbel und Einlegeboden  
 Móvel de serviço / gaveteiro para compartimento interno móvel de serviço e prateleira

**M1**

Melaminico sp. 18/25 mm

Melamine 18/25 mm thick  
 Melamina 18/25 mm de grosor  
 Melaminé ép. 18/25 mm  
 Melamin st. 18/25 mm  
 Melaminico esp. 18/25 mm

**WN**

Bianco opaco

Matt white  
 Blanco opaco  
 Blanc mat  
 Mattweiß  
 Branco fosco

**RC**

Rovere chiaro

Light oak  
 Roble claro  
 Chêne clair  
 Eiche hell  
 Carvalho claro

**NM**

Noce "Maroncelli"

Walnut "Maroncelli"  
 Nogal "Maroncelli"  
 Noyer "Maroncelli"  
 Nussbaum "Maroncelli"  
 Nogueira "Maroncelli"

**RS**

Rovere scuro

Dark oak  
 Roble oscuro  
 Chêne foncé  
 Eiche dunkel  
 Carvalho escuro

**RM**

Rovere moro

Dark oak  
 Roble oscuro  
 Chêne foncé  
 Eiche dunkel  
 Carvalho escuro

**RT**

Rovere tabacco

Tobacco oak  
 Roble tabaco  
 Chêne tabac  
 Eiche tabak  
 Carvalho tabaco

**M2**

Melaminico sp. 18/25 mm

Melamine 18/25 mm thick  
 Melamina 18/25 mm de grosor  
 Melaminé ép. 18/25 mm  
 Melamin st. 18/25 mm  
 Melaminico esp. 18/25 mm

**NO**

Nero opaco

Matt black  
 Negro mate  
 Noir mat  
 Schwarz matt  
 Preto opaco

**L**

Laminato sp. 18/25 mm

Laminate 18/25 mm thick  
 Laminado 18/25 mm de grosor  
 Laminé ép. 18/25 mm  
 Laminat st. 18/25 mm  
 Laminado esp. 18/25 mm

**WL**

Bianco lucido

Polished white  
 Blanco brillo  
 Blanc luisant  
 Weiß hochglanz  
 Branco brilhante

**V81** **Mobile di servizio - LATO SINISTRO (SX) o LATO DESTRO (DX)**  
 Service unit - LEFT HAND (SX) or RIGHT HAND (DX)  
 Mueble auxiliar - LADO IZQUIERDO (SX) o LADO DERECHO (DX)  
 Desserte - CÔTÉ GAUCHE (SX) ou CÔTÉ DROITE (DX)  
 Beistellschrank - LINKS (SX) oder RECHT (DX)  
 Móvel de serviço - LATERAL ISQUIERDA (SX) ou LATERAL DIREITO (DX)

**SX/L**

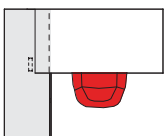

**DX/R**

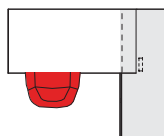

**V10** **Cassetti interni disponibili in melaminico rivestiti in PVC (\*) o metallico (\*\*)**  
 Inside drawers available with melamine coated with PVC (\*) or metal (\*\*)  
 Interior de los cajones disponibles en melamina revestida en PVC (\*) o en metal (\*\*)  
 Intérieur tiroir disponibles en mélaminé revêtus de PVC (\*) ou métal (\*\*)  
 Interne Schublade verfügbar in folgenden Ausführungen aus Melamin PVC Spanplatte (\*) oder Metall (\*\*)  
 Gavetas internas disponíveis em melamínico revestidas em PVC (\*) ou metálico (\*\*)

**DFT \***

Grigio chiaro (standard)

Light grey (standard)  
 Gris claro (standard)  
 Gris clair (standard)  
 Hellgrau (standard)  
 Cinza claro (standard)

**AL01 \*\***

Alluminio

Aluminium  
 Alumínio  
 Aluminium  
 Aluminium  
 Alumínio

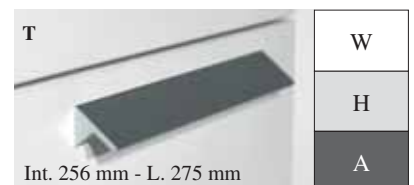
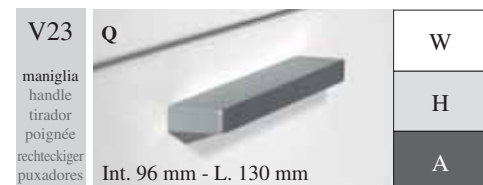

## POSIZIONAMENTO TAVOLI SCRIVANIA SU MOBILI DI SERVIZIO

Desk positioning on service unit / Posición mesas sobre muebles auxiliares / Positionnement du bureau sur meuble desserte / Schreibtischposition auf Beistellmöbel / Posicionamento da mesa escrivania sobre o móvel de serviço

I tavoli possono essere montati sui mobili di servizio P. 66 - 92,5 cm D. 26" - 36 1/2" (destri o sinistri) scegliendo tra 3 diverse posizioni. Per ogni soluzione compositiva è disponibile a listino la dimensione del corrispondente modesty panel (vedi relativa quota indicata con MP) mentre il canale passacavi si ordina secondo la lunghezza del piano di lavoro utilizzato / The desks can be fixed on the service units depth 66 - 92,5 cm 26" - 36 1/2" (right or left hand) in 3 different positions. In the price list you can find the proper modesty panel to match according to the composition choose (see sizes indicated with the MP), while the cable channels change according to the size of the working top / Las mesas se pueden montar con muebles auxiliares P. 66 - 92,5 cm D. 26" - 36 1/2" (derechos o izquierdos) eligiendo entre 3 diferentes posiciones. Por cada solución está disponible, en tarifa, la dimensión del correspondiente faldón (ver medida indicada con MP), mientras que el canal pasacables se pide según la medida del sobre de trabajo / Les bureaux peuvent être fixés sur les dessertes P. 66 - 92,5 cm D. 26" - 36 1/2" (droit ou gauche) en choisissant parmi 3 différentes solutions. Pour chaque composition, la dimension du voile de fond correspondant (voir la cote indiquée par MP) est proposée dans le bordereau des prix, alors que la goulotte est à commander suivant la longueur du plateau utilisé / Die Tische können in 3 verschiedenen Positionen auf den Beistellmöbeln T. 66 - 92,5 cm D. 26" - 36 1/2" (rechts oder links) montiert werden. Für jede Lösung steht in der Preisliste die Abmessung der entsprechenden Knieblende zur Auswahl (siehe entsprechender Preis mit MP), während der Kabelkanal je nach Länge der verwendeten Tischplatte zu bestellen ist / As mesas podem ser montadas nos móveis de serviço P. 66 - 92,5 cm D. 26" - 36 1/2" (direitos ou esquerdos) a escolher entre 3 diferentes posições. Para cada solução componível encontra-se na lista de preços, a dimensão correspondente do modesty panel (vide relativa cota indicada por MP), enquanto o relativo canal passa-cabos é encomendado de acordo com o comprimento da mesa de trabalho utilizada

Le 3 possibili posizioni di montaggio tavoli L. 180 cm - W. 70 3/4" P. 90 cm - D. 35 1/2" sul mobile di servizio P. 66 cm - D. 26" / 3 solutions with desks W. 180 cm - 70 3/4" D. 90 cm - 35 1/2" with service unit D. 66 cm - 26" / Las 3 opciones de montaje mesas L. 180 cm - W. 70 3/4" P. 90 cm - D. 35 1/2" sobre el mueble de servicio P. 66 cm - D. 26" / Les 3 possibilités de montage des bureaux L. 180 cm - W. 70 3/4" P. 90 cm - D. 35 1/2" sur desserte P. 66 cm - D. 26" / Die 3 möglichen Montagepositionen für Tische B. 180 cm - W. 70 3/4" T. 90 cm - D. 35 1/2" auf Beistellmöbel T. 66 cm - D. 26" / As 3 posições de montagem previstas para mesas L. 180 cm - W. 70 3/4" P. 90 cm - D. 35 1/2" com móvel de serviço P. 66 cm - D. 26"

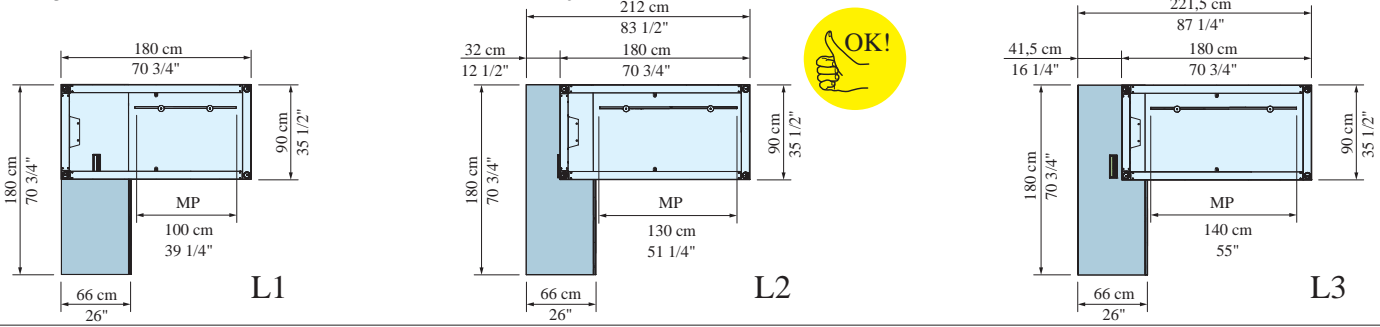

Le 3 possibili posizioni di montaggio tavoli L. 200 cm - W. 78 3/4" P. 90 cm - D. 35 1/2" sul mobile di servizio P. 66 cm - D. 26" / 3 solutions with desks W. 200 cm - 78 3/4" D. 90 cm - 35 1/2" with service unit D. 66 cm - 26" / Las 3 opciones de montaje mesas L. 200 cm - W. 78 3/4" P. 90 cm - D. 35 1/2" sobre el mueble de servicio P. 66 cm - D. 26" / Les 3 possibilités de montage des bureaux L. 200 cm - W. 78 3/4" P. 90 cm - D. 35 1/2" sur desserte P. 66 cm - D. 26" / Die 3 möglichen Montagepositionen für Tische B. 200 cm - W. 78 3/4" T. 90 cm - D. 35 1/2" auf Beistellmöbel T. 66 cm - D. 26" / As 3 posições de montagem previstas para mesas L. 200 cm - W. 78 3/4" P. 90 cm - D. 35 1/2" com móvel de serviço P. 66 cm - D. 26"

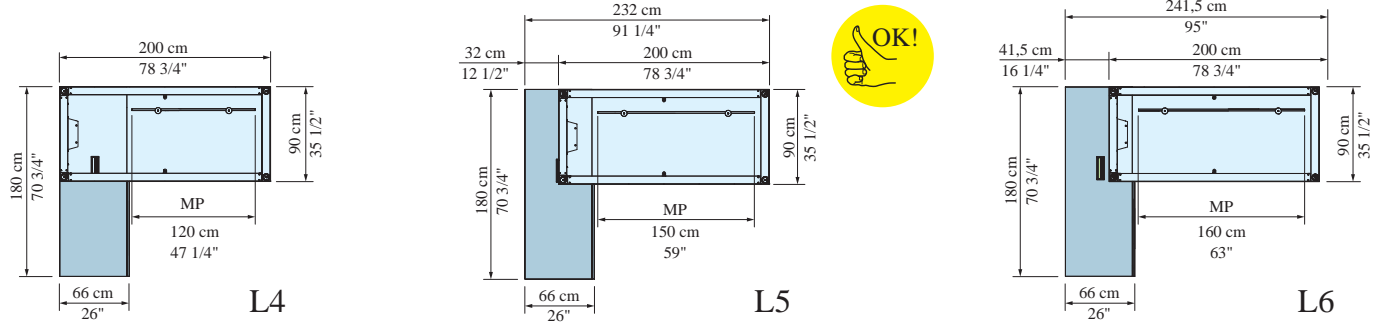

Le 3 possibili posizioni di montaggio tavoli L. 180 cm - W. 70 3/4" P. 90 cm - D. 35 1/2" sul mobile di servizio P. 92,5 cm - D. 36 1/2" / 3 solutions with desks W. 180 cm - 70 3/4" D. 90 cm - 35 1/2" with service unit D. 92,5 cm - 36 1/2" / Las 3 opciones de montaje mesas L. 180 cm - W. 70 3/4" P. 90 cm - D. 35 1/2" sobre el mueble de servicio P. 92,5 cm - D. 36 1/2" / Les 3 possibilités de montage des bureaux L. 180 cm - W. 70 3/4" P. 90 cm - D. 35 1/2" sur desserte P. 92,5 cm - D. 36 1/2" / Die 3 möglichen Montagepositionen für Tische B. 180 cm - W. 70 3/4" T. 90 cm - D. 35 1/2" auf Beistellmöbel T. 92,5 cm - D. 36 1/2" / As 3 posições de montagem previstas para mesas L. 180 cm - W. 70 3/4" P. 90 cm - D. 35 1/2" com móvel de serviço P. 92,5 cm - D. 36 1/2"

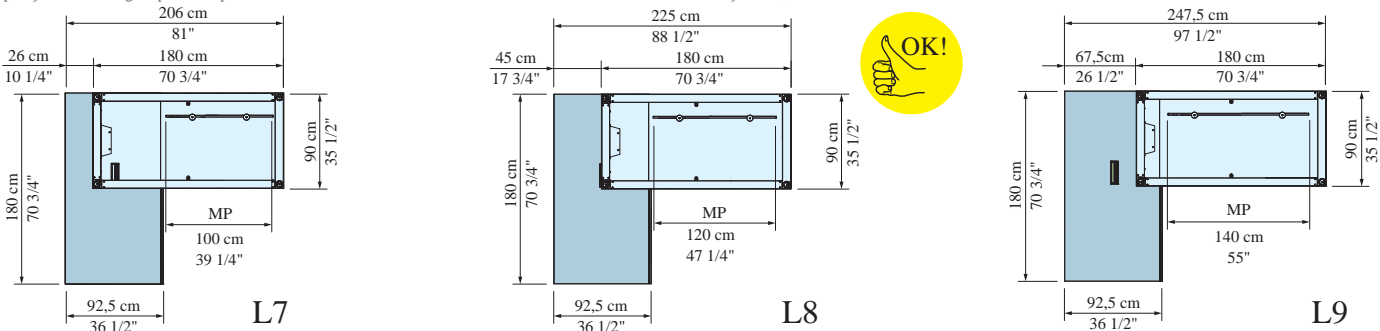

Le 3 possibili posizioni di montaggio tavoli L. 200 cm - W. 78 3/4" P. 90 cm - D. 35 1/2" sul mobile di servizio P. 92,5 cm - D. 36 1/2" / 3 solutions with desks W. 200 cm - 78 3/4" D. 90 cm - 35 1/2" with service unit D. 92,5 cm - 36 1/2" / Las 3 opciones de montaje mesas L. 200 cm - W. 78 3/4" P. 90 cm - D. 35 1/2" sobre el mueble de servicio P. 92,5 cm - D. 36 1/2" / Les 3 possibilités de montage des bureaux L. 200 cm - W. 78 3/4" P. 90 cm - D. 35 1/2" sur desserte P. 92,5 cm - D. 36 1/2" / Die 3 möglichen Montagepositionen für Tische B. 200 cm - W. 78 3/4" T. 90 cm - D. 35 1/2" auf Beistellmöbel T. 92,5 cm - D. 36 1/2" / As 3 posições de montagem previstas para mesas L. 200 cm - W. 78 3/4" P. 90 cm - D. 35 1/2" com móvel de serviço P. 92,5 cm - D. 36 1/2"

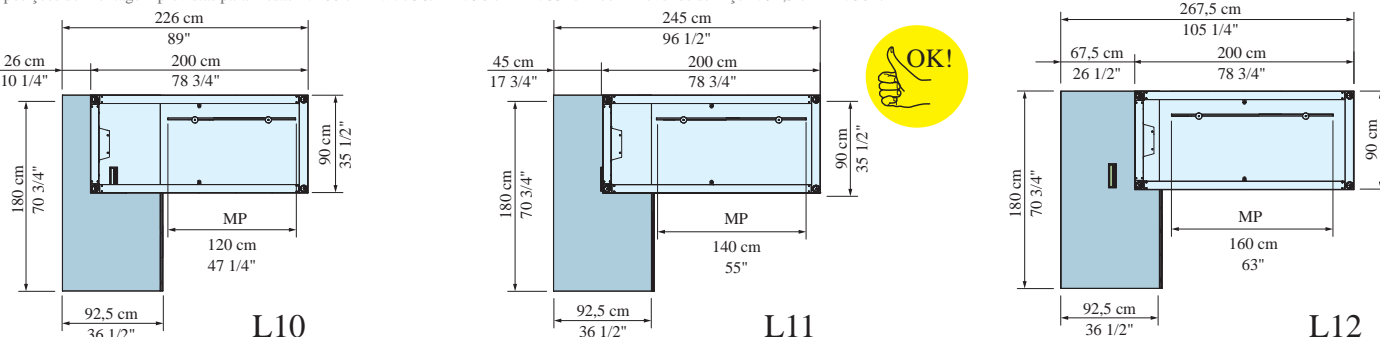

Soluzione base / Suggested solution / Solución aconsejada / Solution conseillée / Empfohlene Lösung / Solução básica

- DV913 VIGO
- DV911 NOTO
- DV909 TOKIO
- DV905 RYM
- DV903 TAY
- DV901 VERTIGO
- DV902 PLANETA

# DV902 Planeta

I tavoli si possono fissare sul mobile di servizio in diverse posizioni. Per ordinare il modesty panel vedi relativa nota tecnica

The desks can be fixed on the service unit with different positions. To order the modesty panel, please see technical note

Las mesas se pueden fijar al mueble auxiliar en diferentes soluciones. Para pedir el faldón ver relativa notas técnicas

Les bureaux peuvent être xés sur le meuble de service en diverses positions. Pour commander le voile de fond, voir note technique

Die Schreibtische können an dem Beistellmöbel in verschiedenen Positionen befestigt werden. Für die Bestellung der Sichtblende, siehe technischer Hinweis

As mesas com cm podem ser xadas no móvel de serviço em posições diversas. Para encomendar o modesty panel, ver nota técnica relacionada

TAVOLI CON MOBILI DI SERVIZIO DESK WITH SERVICE UNIT	V04	L. W.	P. D.	H. H.	LP. TL.	MSP. SUD.	CODICE CODE	V01				Kg. lb	m³ ft³	n. no.
								M1	M2	L	C			
	M1	L1-L2 L3	180 70 7/8"	75 29 5/8"	180 70 3/4"	66 26"	902.TM.6M.18	1.981	2.051	2.173	3.007	159,60 351,91	0,422 14,91	9 9
	M2	L1-L2 L3	180 70 7/8"	75 29 5/8"	180 70 3/4"	66 26"	902.TM.6M.18	2.267	2.337	2.459	3.293	159,60 351,91	0,422 14,91	9 9
	L	L1-L2 L3	180 70 7/8"	75 29 5/8"	180 70 3/4"	66 26"	902.TM.6W.18	2.732	2.802	2.924	3.758	159,60 351,91	0,422 14,91	9 9
	M1	L4-L5 L6	180 70 7/8"	75 29 5/8"	200 78 3/4"	66 26"	902.TM.6M.20	2.006	2.071	2.220	3.162	166,20 366,47	0,434 15,33	9 9
	M2	L4-L5 L6	180 70 7/8"	75 29 5/8"	200 78 3/4"	66 26"	902.TM.6M.20	2.292	2.357	2.506	3.448	166,20 366,47	0,434 15,33	9 9
	L	L4-L5 L6	180 70 7/8"	75 29 5/8"	200 78 3/4"	66 26"	902.TM.6W.20	2.757	2.822	2.971	3.913	166,20 366,47	0,434 15,33	9 9
tavolo scrivania con mobile di servizio desk with service unit mesa con mueble auxiliar bureau a/desserte Schreibtisch mit Beistellmöbel mesa tipo escrivaninha com móvel de serviço	M1	L7-L8 L9	180 70 7/8"	75 29 5/8"	180 70 3/4"	92,5 36 1/2"	902.TM.9M.18	2.211	2.281	2.403	3.237	196,30 432,84	0,506 17,87	10 10
	M2	L1-L2 L3	180 70 7/8"	75 29 5/8"	180 70 3/4"	92,5 36 1/2"	902.TM.9M.18	2.580	2.650	2.772	3.606	196,30 432,84	0,506 17,87	10 10
	L	L7-L8 L9	180 70 7/8"	75 29 5/8"	180 70 3/4"	92,5 36 1/2"	902.TM.9W.18	3.158	3.228	3.350	4.184	196,30 432,84	0,506 17,87	10 10
	M1	L10-L11 L12	180 70 7/8"	75 29 5/8"	200 78 3/4"	92,5 36 1/2"	902.TM.9M.20	2.236	2.301	2.450	3.392	202,90 447,39	0,518 18,30	10 10
	M2	L10-L11 L12	180 70 7/8"	75 29 5/8"	200 78 3/4"	92,5 36 1/2"	902.TM.9M.20	2.605	2.670	2.819	3.761	202,90 447,39	0,518 18,30	10 10
	L	L10-L11 L12	180 70 7/8"	75 29 5/8"	200 78 3/4"	92,5 36 1/2"	902.TM.9W.20	3.183	3.248	3.397	4.339	202,90 447,39	0,518 18,30	10 10

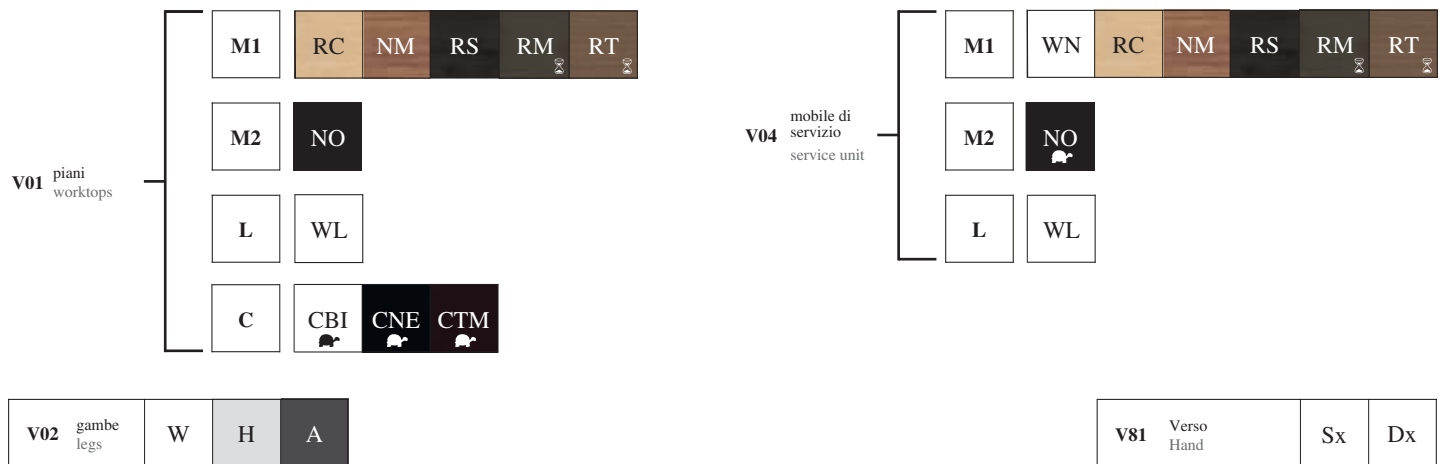



# DV902 Planeta

I tavoli si possono fissare sul mobile di servizio in diverse posizioni. Per ordinare il modesty panel vedi relativa nota tecnica

The desks can be fixed on the service unit with different positions. To order the modesty panel, please see technical note

Las mesas se pueden fijar al mueble auxiliar en diferentes soluciones. Para pedir el faldón ver relativa notas técnicas

Les bureaux peuvent être xés sur le meuble de service en diverses positions. Pour commander le voile de fond, voir note technique

Die Schreibtische können an dem Beistellmöbel in verschiedenen Positionen befestigt werden. Für die Bestellung der Sichtblende, siehe technischer Hinweis

As mesas com cm podem ser xadas no móvel de serviço em posições diversas. Para encomendar o modesty panel, ver nota técnica relacionada

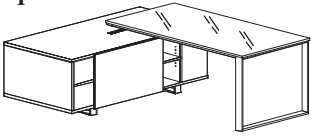
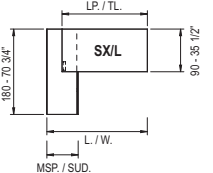
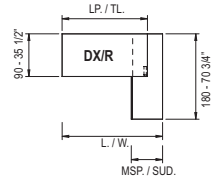
TAVOLI CON MOBILI DI SERVIZIO DESK WITH SERVICE UNIT	V04	L. W.	P. D.	H. H.	LP. TL.	MSP. SUD.	CODICE CODE	V01			Kg. lb	m <sup>3</sup> ft <sup>3</sup>	n. no.
								VW	VAN	GRES			
   <b>tavolo scrivania in vetro con mobile di servizio</b> desk with glass top with service unit mesa de cristal con mueble auxiliar bureau verre a/desserte Schreibtisch aus Glas mit Beistellmöbel mesa tipo escrivaninha em vidro com móvel de serviço	M1	L1-L2 L3	180 70 7/8"	75 29 5/8"	180 70 3/4"	66 26"	902.TV.6M.18	2.570	2.657	5.332	186,60 411,45	0,492 17,38	9 9
	M2	L1-L2 L3	180 70 7/8"	75 29 5/8"	180 70 3/4"	66 26"	902.TV.6M.18	2.856	2.943	5.618	186,60 411,45	0,492 17,38	9 9
	L	L1-L2 L3	180 70 7/8"	75 29 5/8"	180 70 3/4"	66 26"	902.TV.6W.18	3.321	3.408	6.083	186,60 411,45	0,492 17,38	9 9
	M1	L4-L5 L6	180 70 7/8"	75 29 5/8"	200 78 3/4"	66 26"	902.TV.6M.20	2.691	2.983	5.539	191,20 421,59	0,512 18,09	9 9
	M2	L4-L5 L6	180 70 7/8"	75 29 5/8"	200 78 3/4"	66 26"	902.TV.6M.20	2.977	3.269	5.825	191,20 421,59	0,512 18,09	9 9
	L	L4-L5 L6	180 70 7/8"	75 29 5/8"	200 78 3/4"	66 26"	902.TV.6W.20	3.442	3.734	6.290	191,20 421,59	0,512 18,09	9 9
	M1	L7-L8 L9	180 70 7/8"	75 29 5/8"	180 70 3/4"	92,5 36 1/2"	902.TV.9M.18	2.800	2.887	5.562	223,30 492,37	0,576 20,35	10 10
	M2	L7-L8 L9	180 70 7/8"	75 29 5/8"	180 70 3/4"	92,5 36 1/2"	902.TV.9M.18	3.169	3.256	5.931	223,30 492,37	0,576 20,35	10 10
	L	L7-L8 L9	180 70 7/8"	75 29 5/8"	180 70 3/4"	92,5 36 1/2"	902.TV.9W.18	3.747	3.834	6.509	223,30 492,37	0,576 20,35	10 10
	M1	L10-L11 L12	180 70 7/8"	75 29 5/8"	200 78 3/4"	92,5 36 1/2"	902.TV.9M.20	2.921	3.213	5.769	227,90 502,51	0,596 21,06	10 10
	M2	L10-L11 L12	180 70 7/8"	75 29 5/8"	200 78 3/4"	92,5 36 1/2"	902.TV.9M.20	3.290	3.582	6.138	227,90 502,51	0,596 21,06	10 10
	L	L10-L11 L12	180 70 7/8"	75 29 5/8"	200 78 3/4"	92,5 36 1/2"	902.TV.9W.20	3.868	4.160	6.716	227,90 502,51	0,596 21,06	10 10

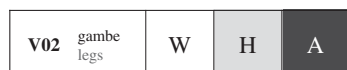
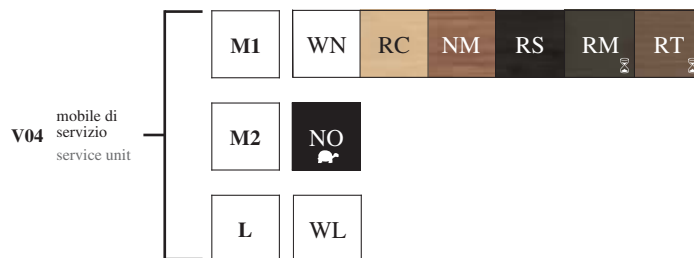
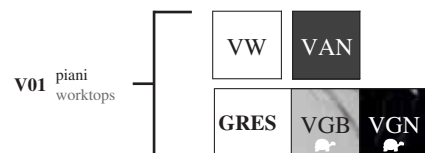

DV913 VIGO  
DV911 NOTO  
DV909 TOKIO  
DV905 RYM  
DV903 TAY  
DV901 VERTIGO  
DV902 PLANETA

# DV902 Planeta

**I tavoli si possono fissare sul mobile di servizio in diverse posizioni. Per ordinare il modesty panel vedi relativa nota tecnica**

The desks can be fixed on the service unit with different positions. To order the modesty panel, please see technical note

Las mesas se pueden fijar al mueble auxiliar en diferentes soluciones. Para pedir el faldón ver relativa notas técnicas

Les bureaux peuvent être xés sur le meuble de service en diverses positions. Pour commander le voile de fond, voir note technique

Die Schreibtische können an dem Beistellmöbel in verschiedenen Positionen befestigt werden. Für die Bestellung der Sichtblende, siehe technischer Hinweis

As mesas com cm podem ser xadas no móvel de serviço em posições diversas. Para encomendar o modesty panel, ver nota técnica relacionada

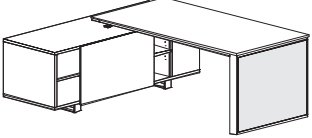
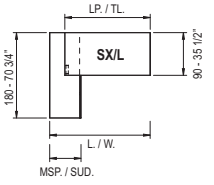
TAVOLI CON MOBILI DI SERVIZIO DESK WITH SERVICE UNIT	V04 V07	L. W.	P. D.	H. H.	LP. TL.	MSP. SUD.	CODICE CODE	V01				Kg. lb	m <sup>3</sup> ft <sup>3</sup>	n. no.
								M1	M2	L	C			
	M1	L1-L2 L3	180 70 7/8"	75 29 5/8"	180 70 3/4"	66 26"	<b>902.PM.6M.18</b>	<b>2.081</b>	<b>2.151</b>	<b>2.273</b>	<b>3.107</b>	178,60 393,81	0,460 16,25	10 10
	M2	L1-L2 L3	180 70 7/8"	75 29 5/8"	180 70 3/4"	66 26"	<b>902.PM.6M.18</b>	<b>2.433</b>	<b>2.503</b>	<b>2.625</b>	<b>3.459</b>	178,60 393,81	0,460 16,25	10 10
	L	L1-L2 L3	180 70 7/8"	75 29 5/8"	180 70 3/4"	66 26"	<b>902.PM.6W.18</b>	<b>2.976</b>	<b>3.046</b>	<b>3.168</b>	<b>4.002</b>	178,60 393,81	0,460 16,25	10 10
	M1	L4-L5 L6	180 70 7/8"	75 29 5/8"	200 78 3/4"	66 26"	<b>902.PM.6M.20</b>	<b>2.106</b>	<b>2.171</b>	<b>2.320</b>	<b>3.262</b>	185,20 408,36	0,472 16,67	10 10
	M2	L4-L5 L6	180 70 7/8"	75 29 5/8"	200 78 3/4"	66 26"	<b>902.PM.6M.20</b>	<b>2.458</b>	<b>2.523</b>	<b>2.672</b>	<b>3.614</b>	185,20 408,36	0,472 16,67	10 10
	L	L4-L5 L6	180 70 7/8"	75 29 5/8"	200 78 3/4"	66 26"	<b>902.PM.6W.20</b>	<b>3.001</b>	<b>3.066</b>	<b>3.215</b>	<b>4.157</b>	185,20 408,36	0,472 16,67	10 10
<b>tavolo scrivania con gamba pannellata e mobile di servizio</b> desk with panelled leg and service unit mesa con pata panelada y mueble auxiliar bureau a/pied panneau et desserte Schreibtisch mit Wangenfuss und mit Beistellmöbel mesa tipo escrivaninha com perna em painel e móvel de serviço	M1	L7-L8 L9	180 70 7/8"	75 29 5/8"	180 70 3/4"	92,5 36 1/2"	<b>902.PM.9M.18</b>	<b>2.311</b>	<b>2.381</b>	<b>2.503</b>	<b>3.337</b>	215,30 474,73	0,544 19,22	11 11
	M2	L1-L2 L3	180 70 7/8"	75 29 5/8"	180 70 3/4"	92,5 36 1/2"	<b>902.PM.9M.18</b>	<b>2.746</b>	<b>2.816</b>	<b>2.938</b>	<b>3.772</b>	215,30 474,73	0,544 19,22	11 11
	L	L7-L8 L9	180 70 7/8"	75 29 5/8"	180 70 3/4"	92,5 36 1/2"	<b>902.PM.9W.18</b>	<b>3.402</b>	<b>3.472</b>	<b>3.594</b>	<b>4.428</b>	215,30 474,73	0,544 19,22	11 11
	M1	L10-L11 L12	180 70 7/8"	75 29 5/8"	200 78 3/4"	92,5 36 1/2"	<b>902.PM.9M.20</b>	<b>2.336</b>	<b>2.401</b>	<b>2.550</b>	<b>3.492</b>	221,90 489,28	0,556 19,64	11 11
	M2	L10-L11 L12	180 70 7/8"	75 29 5/8"	200 78 3/4"	92,5 36 1/2"	<b>902.PM.9M.20</b>	<b>2.771</b>	<b>2.836</b>	<b>2.985</b>	<b>3.927</b>	221,90 489,28	0,556 19,64	11 11
	L	L10-L11 L12	180 70 7/8"	75 29 5/8"	200 78 3/4"	92,5 36 1/2"	<b>902.PM.9W.20</b>	<b>3.427</b>	<b>3.492</b>	<b>3.641</b>	<b>4.583</b>	221,90 489,28	0,556 19,64	11 11



V02 gambe legs	W	H	A
----------------	---	---	---

V81 Verso Hand	Sx	Dx
----------------	----	----

# DV902 Planeta

I tavoli si possono fissare sul mobile di servizio in diverse posizioni. Per ordinare il modesty panel vedi relativa nota tecnica

The desks can be fixed on the service unit with different positions. To order the modesty panel, please see technical note

Las mesas se pueden fijar al mueble auxiliar en diferentes soluciones. Para pedir el faldón ver relativa notas técnicas

Les bureaux peuvent être xés sur le meuble de service en diverses positions. Pour commander le voile de fond, voir note technique

Die Schreibtische können an dem Beistellmöbel in verschiedenen Positionen befestigt werden. Für die Bestellung der Sichtblende, siehe technischer Hinweis

As mesas com cm podem ser xadas no móvel de serviço em posições diversas. Para encomendar o modesty panel, ver nota técnica relacionada

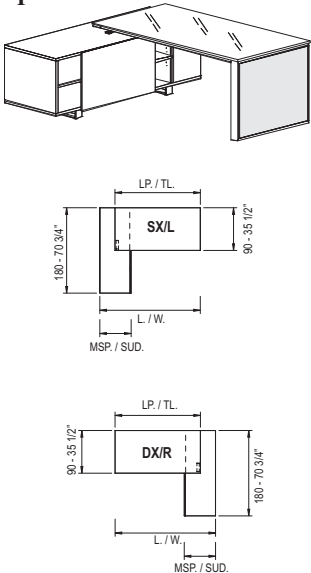
TAVOLI CON MOBILI DI SERVIZIO DESK WITH SERVICE UNIT	V04 V07	L. W.	P. D.	H. H.	LP. TL.	MSP. SUD.	CODICE CODE	V01			Kg. lb	m <sup>3</sup> ft <sup>3</sup>	n. no.
								VW	VAN	GRES			
 <p><b>T</b></p> <p>180 - 70 3/4" LP / TL 90 - 35 1/2" SX/L L / W. MSP. / SUD.</p> <p>90 - 35 1/2" LP / TL 180 - 70 3/4" DX/R L / W. MSP. / SUD.</p> <p><b>tavolo scrivania in vetro con gamba pannellata e mobile di servizio</b> desk with glass top with panelled leg and service unit mesa de cristal con pata panelada y mueble auxiliar bureau verre a/pied panneau et desserte Schreibtisch aus Glas mit Wangenfuss und mit Beistellmöbel mesa tipo escrivantina em vidro com perna em painel e móvel de serviço</p>	M1	L1-L2 L3	180 70 7/8"	75 29 5/8"	180 70 3/4"	66 26"	902.PV.6M.18	2.670	2.757	5.432	205,60 453,34	0,530 18,72	10 10
	M2	L1-L2 L3	180 70 7/8"	75 29 5/8"	180 70 3/4"	66 26"	902.PV.6M.18	3.022	3.109	5.784	205,60 453,34	0,530 18,72	10 10
	L	L1-L2 L3	180 70 7/8"	75 29 5/8"	180 70 3/4"	66 26"	902.PV.6W.18	3.565	3.652	6.327	205,60 453,34	0,530 18,72	10 10
	M1	L4-L5 L6	180 70 7/8"	75 29 5/8"	200 78 3/4"	66 26"	902.PV.6M.20	2.791	3.083	5.639	210,20 463,49	0,550 19,43	10 10
	M2	L4-L5 L6	180 70 7/8"	75 29 5/8"	200 78 3/4"	66 26"	902.PV.6M.20	3.143	3.435	5.991	210,20 463,49	0,550 19,43	10 10
	L	L4-L5 L6	180 70 7/8"	75 29 5/8"	200 78 3/4"	66 26"	902.PV.6W.20	3.686	3.978	6.534	210,20 463,49	0,550 19,43	10 10
	M1	L7-L8 L9	180 70 7/8"	75 29 5/8"	180 70 3/4"	92,5 36 1/2"	902.PV.9M.18	2.900	2.987	5.662	242,30 534,27	0,614 21,69	11 11
	M2	L7-L8 L9	180 70 7/8"	75 29 5/8"	180 70 3/4"	92,5 36 1/2"	902.PV.9M.18	3.335	3.422	6.097	242,30 534,27	0,614 21,69	11 11
	L	L7-L8 L9	180 70 7/8"	75 29 5/8"	180 70 3/4"	92,5 36 1/2"	902.PV.9W.18	3.991	4.078	6.753	242,30 534,27	0,614 21,69	11 11
	M1	L10-L11 L12	180 70 7/8"	75 29 5/8"	200 78 3/4"	92,5 36 1/2"	902.PV.9M.20	3.021	3.313	5.869	246,90 544,41	0,634 22,40	11 11
	M2	L10-L11 L12	180 70 7/8"	75 29 5/8"	200 78 3/4"	92,5 36 1/2"	902.PV.9M.20	3.456	3.748	6.304	246,90 544,41	0,634 22,40	11 11
	L	L10-L11 L12	180 70 7/8"	75 29 5/8"	200 78 3/4"	92,5 36 1/2"	902.PV.9W.20	4.112	4.404	6.960	246,90 544,41	0,634 22,40	11 11

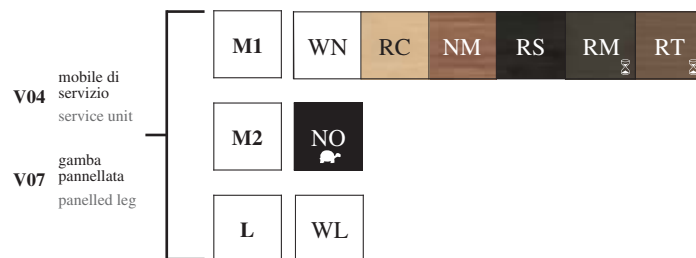

V02 gambe legs

W	H	A
---	---	---

V81 Verso Hand

Sx	Dx
----	----

DV913 VIGO  
DV911 NOTO  
DV909 TOKIO  
DV905 RYM  
DV903 TAY  
DV901 VERTIGO  
DV902 PLANETA

# DV902 Planeta

V01 piani worktops	V07 gamba pannellata panelled leg	M1	RC	NM	RS	RM	RT	L	WL
		M2	NO					C	CBI

V02 gambe legs	W	H	A
----------------	---	---	---

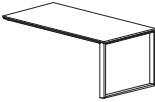
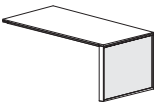
TAVOLI INTEGRABILI CON MOBILE DI SERVIZIO INTEGRABLE DESKS FOR SERVICE UNITS	V07	L. W.	P. D.	H. H.	CODICE CODE	V01				Kg. lb	m <sup>3</sup> ft <sup>3</sup>	n. no.
						M1	M2	L	C			
 <p><b>tavolo scrivania con gamba aperta</b> desk with open leg mesa con pata abierta bureau a/piét.ouvert Schreibtisch mit offenem Bein mesa tipo escrivaninha com perna aberta</p>	-	180 70 7/8"	90 35 1/2"	75 29 5/8"	<b>902.TI.15.18</b>	<b>724</b>	<b>794</b>	<b>916</b>	<b>1.750</b>	45,50 100,32	0,175 6,18	4 4
	-	200 78 3/4"	90 35 1/2"	75 29 5/8"	<b>902.TI.15.20</b>	<b>749</b>	<b>814</b>	<b>963</b>	<b>1.905</b>	52,10 114,88	0,187 6,60	4 4
	M1	180 70 7/8"	90 35 1/2"	75 29 5/8"	<b>902.TI.1M.18</b>	<b>824</b>	<b>894</b>	<b>1.016</b>	<b>1.850</b>	64,50 142,22	0,213 7,52	5 5
 <p><b>tavolo scrivania con gamba pannellata</b> desk with panelled leg mesa con pata panelada bureau a/pied panneau Schreibtisch mit Wangenfuss mesa tipo escrivaninha com perna em painel</p>	M2	180 70 7/8"	90 35 1/2"	75 29 5/8"	<b>902.TI.1M.18</b>	<b>890</b>	<b>960</b>	<b>1.082</b>	<b>1.916</b>	64,50 142,22	0,213 7,52	5 5
	L	180 70 7/8"	90 35 1/2"	75 29 5/8"	<b>902.TI.1W.18</b>	<b>968</b>	<b>1.038</b>	<b>1.160</b>	<b>1.994</b>	45,50 100,32	0,175 6,18	4 4
	M1	200 78 3/4"	90 35 1/2"	75 29 5/8"	<b>902.TI.1M.20</b>	<b>849</b>	<b>914</b>	<b>1.063</b>	<b>2.005</b>	71,10 156,77	0,225 7,95	5 5
	M2	200 78 3/4"	90 35 1/2"	75 29 5/8"	<b>902.TI.1M.20</b>	<b>915</b>	<b>980</b>	<b>1.129</b>	<b>2.071</b>	71,10 156,77	0,225 7,95	5 5
	L	200 78 3/4"	90 35 1/2"	75 29 5/8"	<b>902.TI.1W.20</b>	<b>993</b>	<b>1.058</b>	<b>1.207</b>	<b>2.149</b>	52,10 114,88	0,187 6,60	4 4

# DV902 Planeta

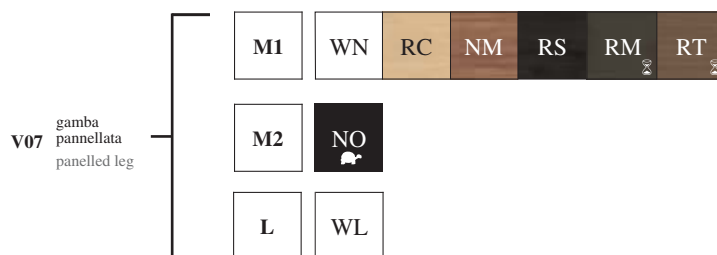
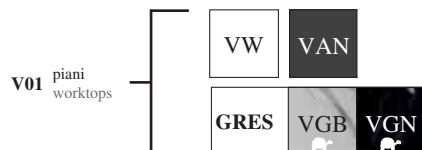

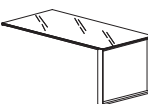
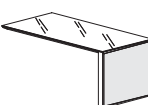
TAVOLI INTEGRABILI CON MOBILE DI SERVIZIO INTEGRABLE DESKS FOR SERVICE UNITS	V07 PAN. PAN.	L. W.	P. D.	H. H.	CODICE CODE	V01			Kg. lb	m <sup>3</sup> ft <sup>3</sup>	n. no.
						VW	VAN	GRES			
 <p><b>T</b> <b>tavolo scrivania in vetro temperato con gamba aperta</b> desk with tempered glass top with open leg Mesa de cristal templado con pata abierta bureau verre trempé a/piét.ouvert Schreibtisch aus gehärtetem Glas mit offenem Bein mesa tipo escrivaninha em vidro temperado com perna aberta</p>	-	180 70 7/8"	90 35 1/2"	74 29 1/4"	<b>902.TV.11.18</b>	<b>1.313</b>	<b>1.400</b>	<b>4.075</b>	72,50 159,86	0,234 8,26	4 4
	-	200 78 3/4"	90 35 1/2"	74 29 1/4"	<b>902.TV.11.20</b>	<b>1.434</b>	<b>1.726</b>	<b>4.282</b>	77,10 170,00	0,241 8,51	4 4
 <p><b>T</b> <b>tavolo scrivania in vetro temperato con gamba pannellata</b> desk with tempered glass top with panelled leg mesa de cristal templado con pata panelada bureau verre trempé a/pied panneau Schreibtisch aus gehärtetem Glas mit Wangenfuss mesa tipo escrivaninha em vidro temperado com perna em painel</p>	M1	180 70 7/8"	90 35 1/2"	74 29 1/4"	<b>902.TV.1M.18</b>	<b>1.413</b>	<b>1.500</b>	<b>4.175</b>	91,50 201,75	0,272 9,61	5 5
	M2	180 70 7/8"	90 35 1/2"	74 29 1/4"	<b>902.TV.1M.18</b>	<b>1.479</b>	<b>1.566</b>	<b>4.241</b>	91,50 201,75	0,272 9,61	5 5
	L	180 70 7/8"	90 35 1/2"	74 29 1/4"	<b>902.TV.1W.18</b>	<b>1.557</b>	<b>1.644</b>	<b>4.319</b>	91,50 201,75	0,272 9,61	5 5
	M1	200 78 3/4"	90 35 1/2"	74 29 1/4"	<b>902.TV.1M.20</b>	<b>1.534</b>	<b>1.826</b>	<b>4.382</b>	96,10 211,90	0,279 9,85	5 5
	M2	200 78 3/4"	90 35 1/2"	74 29 1/4"	<b>902.TV.1M.20</b>	<b>1.600</b>	<b>1.892</b>	<b>4.448</b>	96,10 211,90	0,279 9,85	5 5
	L	200 78 3/4"	90 35 1/2"	74 29 1/4"	<b>902.TV.1W.20</b>	<b>1.678</b>	<b>1.970</b>	<b>4.526</b>	96,10 211,90	0,279 9,85	5 5

DV913 VIGO  
DV911 NOTO  
DV909 TOKIO  
DV905 RYM  
DV903 TAY  
DV901 VERTIGO  
DV902 PLANETA

# DV902 Planeta

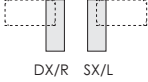
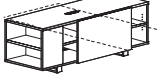
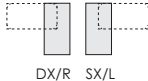
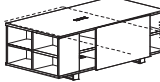
V04 mobile di servizio service unit	M1	WN	RC	NM	RS	RM	RT	V02 gambe legs	W	H	A
	M2	NO				L	WL	V81 Verso Hand	Sx	Dx	
MOBILI DI SERVIZIO SERVICE UNITS	MSF. SUF.	L. W.	P. D.	H. H.	CODICE CODE	V04 / V81	Kg. lb	m³ ft³	n. no.		
 DX/R SX/L  <b>mobile di servizio cm 180x66</b> service unit cm 180x66 mueble auxiliar 180x66 cm desserte 180x66 cm Beistellmöbel 180x66 cm móvel de serviço cm 180x66	M1	180 70 7/8"	66 26"	63 24 7/8"	902.MS.6M.18	1.257	114,10 251,59	0,247 8,72	5 5		
	M2	180 70 7/8"	66 26"	63 24 7/8"	902.MS.6M.18	1.543	114,10 251,59	0,247 8,72	5 5		
	L	180 70 7/8"	66 26"	63 24 7/8"	902.MS.6W.18	2.008	114,10 251,59	0,247 8,72	5 5		
 DX/R SX/L  <b>mobile di servizio cm 180x92,5</b> service unit cm 180x92,5 mueble auxiliar 180x92,5 cm desserte 180x92,5 cm Beistellmöbel 180x92,5 cm móvel de serviço cm 180x92,5	M1	180 70 7/8"	92,5 36 1/2"	63 24 7/8"	902.MS.9M.18	1.487	150,80 332,51	0,331 11,69	6 6		
	M2	180 70 7/8"	92,5 36 1/2"	63 24 7/8"	902.MS.9M.18	1.856	150,80 332,51	0,331 11,69	6 6		
	L	180 70 7/8"	92,5 36 1/2"	63 24 7/8"	902.MS.9W.18	2.434	150,80 332,51	0,331 11,69	6 6		

V10 cassetti interni metal drawers	PVC	DFT
	MET	AL01

V04 cassettiere pedestals	M1	WN	RC	NM	RS	RM	RT	V23 maniglia handle	Q	V	W
	M2	NO				L	WL		T		
											A

CASSETTIERE PER MOBILI DI SERVIZIO PEDESTALS FOR SERVICE UNITS	L. W.	P. D.	H. H.	CODICE CODE	V10-PVC			Kg. lb	m³ ft³	n. no.
					M1	M2	L			
 <b>cassettiera 3 cassetti per vano interno mobile di servizio + ripiano</b> 3 drawers pedestal for inside service unit + shelf cajonera 3 cajones para hueco interior mueble auxiliar + balda caisson 3 tiroirs pour compartiment intérieur desserte + tablette Schubladenelement mit 3 Schüben für internes Beistellmöbel + Einlegeboden gaveteiro 3 gavetas para compartimento interno móvel de serviço + prateleira	42 16 1/2"	55 21 3/4"	48 21 3/4"	550.CM.01.04	325	391	414	27,24 60,06	0,167 5,90	4 4
					V10-MET					
					374	429	452			

# DV902 Planeta

V01 piani  
worktops

M1	RC	NM	RS	RM	RT
M2	NO				

L	WL
---	----

C	CBI	CNE	CTM
---	-----	-----	-----

V02 gambe legs	W	H	A
-------------------	---	---	---

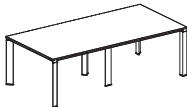
TAVOLI RIUNIONE CONFERENCE TABLES	L. W.	P. D.	H. H.	CODICE CODE	V01 / V02				Kg. lb	m <sup>3</sup> ft <sup>3</sup>	n. no.
					M1	M2	L	C			
 <p><b>tavolo riunioni</b> conference table mesa de reuniones table de réunion Besprechungstisch mesa de reunião</p>	100 39 3/8"	100 39 3/8"	75 29 5/8"	<b>902.TR.42.10</b>	<b>919</b>	<b>969</b>	<b>1.029</b>	<b>1.518</b>	11,70 25,79	0,039 1,37	1 1
 <p><b>tavolo riunioni cm 240x120</b> meeting table cm 240X120 mesa de reuniones de 240x120 cm table de réunion 240x120 cm Besprechungstisch 240x120 cm mesa reunião cm 240x120</p>	240 94 1/2"	75 29 5/8"	120 47 1/4"	<b>902.TR.41.24</b>	<b>1.734</b>	<b>1.983</b>	<b>2.203</b>	<b>3.728</b>	39,50 87,09	0,128 4,52	2 2

sottomano desk pad	N
-----------------------	---

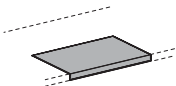
ACCESSORI ACCESSORIES	L. W.	P. D.	H. H.	CODICE CODE	PREZZO PRICE	Kg. lb	m <sup>3</sup> ft <sup>3</sup>	n. no.
 <p><b>sottomano in cuoio nero per tavoli</b> black leather desk pad for tables baden en cuero negro para mesas sous-main en cuir noir pour tables Schreibmappe aus Leder für Schreibtische, Schwarz apoio de mão em couro preto para mesas</p>	90 35 1/2"	60 23 5/8"	2 7/8"	<b>300.AS.01.09</b>	<b>243</b>	5,00 11,02	0,038 1,34	1 1

DV913 VIGO  
DV911 NOTO  
DV909 TOKIO  
DV905 RYM  
DV903 TAY  
DV901 VERTIGO  
DV902 PLANETA

# DV902 Planeta



V01 piani  
worktops

M1	RC	NM	RS	RM	RT
M2	NO				

L	WL
---	----

C	CBI	CNE	CTM
---	-----	-----	-----

V02 gambe legs	W	H	A
-------------------	---	---	---

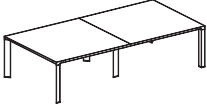
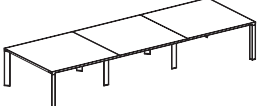



TAVOLI RIUNIONE CONFERENCE TABLES	L. W.	P. D.	H. H.	CODICE CODE	V01 / V02				Kg. lb	m³ ft³	n. no.
					M1	M2	L	C			
 <p><b>tavolo riunioni</b> meeting table mesa de reuniones table de réunion Besprechungstisch mesa de reunião</p>	160 63"	160 63"	75 29 5/8"	<b>902.TR.43.16</b>	<b>1.179</b>	<b>1.450</b>	<b>1.486</b>	<b>2.620</b>	38,10 84,01	0,093 3,28	1 1
 <p><b>elemento tavolo riunioni centrale con gamba rientrata</b> central element meeting table with returned central leg elemento mesa de reuniones central de con pata reentrada élément central table de réunion avec et pied central retourné Zentralbestandteil Besprechungstisch mit zurückspringendem Bein elemento para mesa de reunião central com perna central retornada</p>	160 63"	160 63"	75 29 5/8"	<b>902.TR.32.16</b>	<b>937</b>	<b>1.208</b>	<b>1.244</b>	<b>2.378</b>	41,10 90,62	0,106 3,74	2 2
 <p><b>tavolo riunioni cm 320x160 con gamba centrale rientrata</b> meeting table cm 320x160 with returned central leg mesa de reuniones de 320x160 cm con patas central reentrada table de réunion 320x160 cm avec pieds central retourné Besprechungstisch 320x160 cm mit mittlerem zurückspringendem Bein mesa reunião cm 320x160 com perna central retornada</p>	320 126"	160 63"	75 29 5/8"	<b>902.TR.32.32</b>	<b>2.116</b>	<b>2.658</b>	<b>2.730</b>	<b>4.998</b>	79,20 174,63	0,199 7,03	3 3
 <p><b>tavolo riunioni cm 480x160 con gamba centrale rientrata</b> meeting table cm 480x160 with returned central leg mesa de reuniones de 480x160 cm con patas central reentrada table de réunion 480x160 cm avec pieds central retourné Besprechungstisch 480x160 cm mit mittlerem zurückspringendem Bein mesa reunião cm 480x160 com perna central retornada</p>	480 189"	160 63"	75 29 5/8"	<b>902.TR.32.48</b>	<b>3.053</b>	<b>3.866</b>	<b>3.974</b>	<b>7.376</b>	120,30 265,26	0,305 10,77	5 5



# DV902 Planeta

V01 piani worktops	VW	VAN
	GRES	VGB

V02 gambe legs	W	H	A
----------------	---	---	---

TAVOLI RIUNIONE CONFERENCE TABLES	L. W.	P. D.	H. H.	CODICE CODE	V01 / V02			Kg. lb	m <sup>3</sup> ft <sup>3</sup>	n. no.	
					VW	VAN	GRES				
 <p><b>tavolo riunioni circolare in vetro retrolaccato o gres porcellanato, su gambone in metallo con base</b> round conference table in rear-lacquered glass or porcelain stoneware worktop, with metal column base mesa de reuniones redonda en cristal retrolacado ou en gres porcelánico, con pata cilíndrica de metal table de réunion ronde en verre rétro-laqué ou en grès finition marbre, sur pied-colonne en métal avec base runder Besprechungstisch aus Glas oder Arbeitsplatten in Porzellan Steingut auf Metallsäule mit Säulenfuß mesa de reunião circular em vidro retrolacado ou em grés porcelânico, sobre pedestal em metal cor alumínio com base</p>	T	100 39 3/8"	100 39 3/8"	74,5 29 3/8"	902.TV.15.10	890	1.020	2.303	70,50 155,45	0,143 5,05	4 4
 <p><b>tavolo riunioni circolare in vetro o gres porcellanato su gambone in metallo con base finitura inox</b> round meeting table with glass or stoneware top and with metal column, base inox finish mesa de reuniones redonda en cristal o en gres porcelánico con pata cilíndrica de metal y con base cuadrada acabado inox table de réunion ronde en verre ou en grès finition marbre, sur pied-colonne en métal avec base arrée finition inox runder Besprechungstisch aus Glas oder Porzellan Steingut, auf Metallsäule mit mit quadratischem Fuß Edelstahlfarbig mesa de reunião circular em vidro o grés porcelânico, sobre pedestal em metal cor alumínio com base quadrada, acabamento inox</p>	T	100 39 3/8"	100 39 3/8"	75 29 5/8"	902.TV.14.10	1.031	1.161	2.444	70,50 155,45	0,143 5,05	4 4
 <p><b>tavolo riunioni con piano in vetro retrolaccato o gres porcellanato</b> conference table with rear-lacquered glass or porcelain stoneware worktop mesa de reuniones con sobre en cristal retrolacado ou en gres porcelánico table réunion avec plateau en verre rétro-laqué ou en grès finition marbre Besprechungstisch aus Glas, auf der Rückseite lackiert, oder Arbeitsplatten in Porzellan Steingut mesa de reunião com plano em vidro retrolacado ou em grés porcelânico</p>	T	100 39 3/8"	100 39 3/8"	74,5 29 3/8"	902.TV.77.10	1.575	1.638	2.902	64,00 141,12	0,167 5,90	4 4
 <p><b>tavolo riunioni con piano in vetro retrolaccato o gres porcellanato</b> conference table with rear-lacquered glass or porcelain stoneware worktop mesa de reuniones con sobre en cristal retrolacado ou en gres porcelánico table réunion avec plateau en verre rétro-laqué ou en grès finition marbre Besprechungstisch aus Glas, auf der Rückseite lackiert, oder Arbeitsplatten in Porzellan Steingut mesa de reunião com plano em vidro retrolacado ou em grés porcelânico</p>	T	240 94 1/2"	120 47 1/4"	74,5 29 3/8"	902.TV.36.24	3.328	3.951	7.376	168,40 371,32	0,415 14,66	10 10



gambone alluminio / basamento inox  
aluminium column / stainless steel base

**1 Top access incluso**  
1 Top access included  
1 Top access incluido  
1 Top access compris  
1 Top Access Inbegriffen  
1 Top access incluso  
**Cod. 300.AC.20.03**  
L.34,7 cm - W. 13 3/4"

**2 Top access inclusi**  
2 Top access included  
2 Top access incluido  
2 Top access compris  
2 Top Access Inbegriffen  
2 Top access incluso  
**Cod. 300.AC.20.04**  
L.44,7 cm - W. 17 1/2"

DV913 VIGO  
DV911 NOTO  
DV909 TOKIO  
DV905 RYM  
DV903 TAY  
DV901 VERTIGO  
DV902 PLANETA

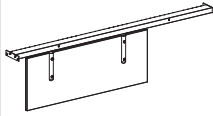
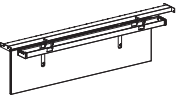

# DV902 Planeta

V09 modesty panel modesty panel	M1	WN	HH	RC	NM	RS	RM	RT	C	CBI	CNE	CTM
	M2	NO				L	WL					

MODESTY PANELS MODESTY PANELS	L. W.	P. D.	H. H.	CODICE CODE	CATEGORIA PREZZO / PRICE CATEGORY				Kg. lb	m³ ft³	n. no.	
					M1	M2	L	C				
 <p><b>modesty panel per tavoli L. 180 cm</b> modesty panel for desks L.180 cm faldón para mesas 180 cm voile de fond pour bureaux L. 180 cm Modesty Paneel für Tisch 180 cm modesty panel para mesas L. 180 cm</p>	L1-L7	100 39 3/8"	1,8 3/4"	38 15"	<b>902.MP.08.10</b>	<b>253</b>	<b>275</b>	<b>315</b>	<b>643</b>	12,60 27,78	0,032 1,13	4 4
	L8	120 47 1/4"	1,8 3/4"	38 15"	<b>902.MP.08.12</b>	<b>260</b>	<b>287</b>	<b>333</b>	<b>686</b>	13,60 29,98	0,035 1,23	4 4
	L2	130 51 1/4"	1,8 3/4"	38 15"	<b>902.MP.08.13</b>	<b>262</b>	<b>289</b>	<b>343</b>	<b>687</b>	14,10 31,09	0,036 1,27	4 4
	L3-L9	140 55 1/8"	1,8 3/4"	38 15"	<b>902.MP.08.14</b>	<b>275</b>	<b>305</b>	<b>347</b>	<b>688</b>	14,60 32,19	0,037 1,30	4 4
 <p><b>modesty panel + canale passacavi in lamiera piegata per tavoli L. 180 cm</b> modesty panel + sheet metal cable channel for desks cm 1.180 cm Faldón + canal pasacable en chapa doblada para mesas L. 180 cm voile de fond + goulotte passe câbles en acier plié pour bureaux L. 180 cm Modesty Paneel + Kabelkanal aus gebogenem Blech für Tisch 180 cm modesty panel + canal passa-cabos em chapa de aço dobrada para mesas L. 180 cm</p>	L1-L7	100 39 3/8"	1,8 3/4"	38 15"	<b>902.MP.23.10</b>	<b>337</b>	<b>359</b>	<b>399</b>	<b>727</b>	15,50 34,17	0,042 1,48	6 6
	L8	120 47 1/4"	1,8 3/4"	38 15"	<b>902.MP.23.12</b>	<b>344</b>	<b>371</b>	<b>417</b>	<b>770</b>	16,50 36,38	0,045 1,59	6 6
	L2	130 51 1/4"	1,8 3/4"	38 15"	<b>902.MP.23.13</b>	<b>346</b>	<b>373</b>	<b>427</b>	<b>771</b>	17,00 37,48	0,046 1,62	6 6
	L3-L9	140 55 1/8"	1,8 3/4"	38 15"	<b>902.MP.23.14</b>	<b>359</b>	<b>389</b>	<b>431</b>	<b>772</b>	17,50 38,58	0,047 1,66	6 6

## Per ordinare il modesty panel vedi relativa nota tecnica

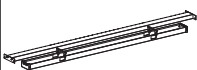
To order the modesty panel, please check technical notes  
 Para pedir el faldón ver relativa notas técnicas  
 Pour commander le voile de fond, voir note technique  
 Zu bestellen die Knieblende siehe entsprechende technischen Hinweis  
 Para encomendar o modesty panel, ver a nota técnica relevante

CANALIZZAZIONE WIRE MANAGEMENT	L. W.	P. D.	H. H.	CODICE CODE	PREZZO PRICE	Kg. lb	m³ ft³	n. no.
 <p><b>canale passacavi in lamiera piegata per tavoli L. 180 cm</b> sheet metal cable channel for desks cm 1.180 cm canal pasacable en chapa doblada para mesas L. 180 cm goulotte passe câbles en acier plié pour bureaux L. 180 cm Kabelkanal aus gebogenem Blech für Tisch 180 cm canal passa-cabos em chapa de aço dobrada para mesas L. 180 cm</p>	180 70 7/8"	10,2 4 1/8"	11,4 4 1/2"	<b>902.AP.25.18</b>	<b>205</b>	6,40 14,11	0,024 0,84	3 3
	 <p><b>canale passacavi in lamiera piegata per modesty panel art. 902.MP.08._</b> sheet metal cable channel for modesty panel art. 902.MP.08._ canal pasacables en chapa doblada para modesty panel art. 902.MP.08._ goulotte passe câbles en acier plié pour modesty panel art. 902.MP.08._ Kabelkanal aus gebogenem Blech, für modesty panel Art. 902.MP.08._ canal passa-cabos em chapa de aço dobrada para modesty panel art. 902.MP.08._</p>	180 70 7/8"	10,2 4 1/8"	11,4 4 1/2"	<b>902.AP.41.18</b>	<b>84</b>	2,90 6,39	0,010 0,35

# DV902 Planeta

V09 modesty panel  
modesty panel

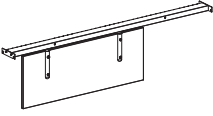
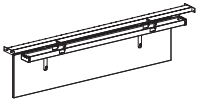

M1	WN	HH	RC	NM	RS	RM	RT
M2	NO					L	WL

C	CBI	CNE	CTM
---	-----	-----	-----

MODESTY PANELS MODESTY PANELS	L. W.	P. D.	H. H.	CODICE CODE	CATEGORIA PREZZO / PRICE CATEGORY				Kg. lb	m <sup>3</sup> ft <sup>3</sup>	n. no.	
					M1	M2	L	C				
 <p><b>modesty panel per tavoli L. 200 cm</b> modesty panel for desks L. 200 cm Faldón para mesa L.200 cm voile de fond pour bureaux L. 200 cm Modesty Paneel für Tisch L.200 cm modesty panel para mesas L. 200 cm</p>	L4-L10	120 47 1/4"	1.8 3/4"	38 15"	<b>902.MP.09.12</b>	<b>267</b>	<b>294</b>	<b>340</b>	<b>693</b>	13,90 30,64	0,036 1,27	4 4
	L11	140 55 1/8"	1.8 3/4"	38 15"	<b>902.MP.09.14</b>	<b>282</b>	<b>211</b>	<b>354</b>	<b>695</b>	14,90 32,85	0,038 1,34	4 4
	L5	150 59 1/8"	1.8 3/4"	38 15"	<b>902.MP.09.15</b>	<b>285</b>	<b>319</b>	<b>361</b>	<b>754</b>	15,40 33,95	0,040 1,41	4 4
	L6-L12	160 63"	1.8 3/4"	38 15"	<b>902.MP.09.16</b>	<b>291</b>	<b>319</b>	<b>365</b>	<b>786</b>	15,90 35,05	0,041 1,44	4 4
 <p><b>modesty panel + canale passacavi in lamiera piegata per tavoli L. 200 cm</b> modesty panel + sheet metal cable channel for desks cm L.200 cm Faldón + canal pasacable en chapa doblada para mesas L. 200 cm voile de fond + goulotte passe câbles en acier plié pour bureaux L. 200 cm Modesty Paneel + Kabelkanal aus gebogenem Blech für Tisch 200 cm modesty panel + canal passa-cabos em chapa de aço dobrada para mesas L. 200 cm</p>	L4-L10	120 47 1/4"	1.8 3/4"	38 15"	<b>902.MP.24.12</b>	<b>354</b>	<b>381</b>	<b>427</b>	<b>780</b>	17,10 37,70	0,047 1,66	6 6
	L11	140 55 1/8"	1.8 3/4"	38 15"	<b>902.MP.24.14</b>	<b>369</b>	<b>399</b>	<b>441</b>	<b>782</b>	18,10 39,91	0,049 1,73	6 6
	L5	150 59 1/8"	1.8 3/4"	38 15"	<b>902.MP.24.15</b>	<b>372</b>	<b>406</b>	<b>448</b>	<b>841</b>	18,60 41,01	0,051 1,80	6 6
	L6-L12	160 63"	1.8 3/4"	38 15"	<b>902.MP.24.16</b>	<b>378</b>	<b>406</b>	<b>452</b>	<b>873</b>	19,10 42,11	0,052 1,83	6 6

## Per ordinare il modesty panel vedi relativa nota tecnica

To order the modesty panel, please check technical notes  
Para pedir el faldón ver relativa notas técnicas  
Pour commander le voile de fond, voir note technique  
Zu bestellen die Knieblende siehe entsprechende technischen Hinweis  
Para encomendar o modesty panel, ver a nota técnica relevante

CANALIZZAZIONE WIRE MANAGEMENT	L. W.	P. D.	H. H.	CODICE CODE	PREZZO PRICE	Kg. lb	m <sup>3</sup> ft <sup>3</sup>	n. no.
 <p><b>canale passacavi in lamiera piegata per tavoli L. 200 cm</b> sheet metal cable channel for desks cm L.200 cm canal pasacable en chapa doblada para mesas L. 200 cm goulotte passe câbles en acier plié pour bureaux L. 200 cm Kabelkanal aus gebogenem Blech für Tisch 200 cm canal passa-cabos em chapa de aço dobrada para mesas L. 200 cm</p>	200 78 3/4"	10,2 4 1/8"	11,4 4 1/2"	<b>902.AP.25.20</b>	<b>215</b>	7,00 15,43	0,026 0,91	3 3
 <p><b>canale passacavi in lamiera piegata per modesty panel art. 902.MP.09._</b> sheet metal cable channel for modesty panel art. 902.MP.09._ canal pasacables en chapa doblada para modesty panel art. 902.MP.09._ goulotte passe câbles en acier plié pour modesty panel art. 902.MP.09._ Kabelkanal aus gebogenem Blech, für modesty panel Art. 902.MP.09._ canal passa-cabos em chapa de aço dobrada para modesty panel art. 902.MP.09._</p>	200 78 3/4"	10,2 4 1/8"	11,4 4 1/2"	<b>902.AP.41.20</b>	<b>87</b>	3,20 7,05	0,011 0,38	2 2

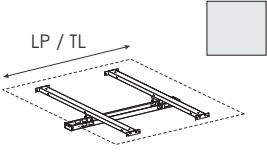
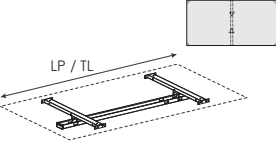
CANALIZZAZIONE WIRE MANAGEMENT	LP. TL.	CODICE CODE	PREZZO PRICE	Kg. lb	m <sup>3</sup> ft <sup>3</sup>	n. no.
 <p><b>canale passacavi in lamiera piegata per tavoli riunione cm 160x160 cm</b></p> <p>cable channels made of sheet metal for meeting tables cm 160x160 cm</p> <p>canal pasacables en chapa doblada para mesas de reuniones cm 160x160 cm</p> <p>goulotte en acier plié pour table de réunion 160x160 cm</p> <p>Kabelkanal aus gebogenem Blech, für Besprechungstisch 160x160 cm</p> <p>canal passa-cabos em chapa de aço dobrada para mesa de reunião cm 160x160 cm</p>	160 63"	<b>902.AP.27.16</b>	<b>287</b>	8,00 17,64	0,030 1,06	2 2
 <p><b>canale passacavi in lamiera piegata per tavoli riunione cm 240x120 cm</b></p> <p>cable channels made of sheet metal for meeting tables cm 240x120 cm</p> <p>canal pasacables en chapa doblada para mesas de reuniones cm 240x120 cm</p> <p>goulotte en acier plié pour table de réunion 240x120 cm</p> <p>Kabelkanal aus gebogenem Blech, für Besprechungstisch 240x120 cm</p> <p>canal passa-cabos em chapa de aço dobrada para mesa de reunião cm 240x120 cm</p>	240 94 1/2"	<b>902.AP.44.24</b>	<b>274</b>	8,30 18,30	0,027 0,95	2 2