

Vertigo

DV901



LINEA DIREZIONALE

EXECUTIVE LINE

SERIE EJECUTIVA

LIGNES DE DIRECTION

DIREKTIONSEINRICHTUNGSPROGRAMME

LINHA DIRECÇÃO

DV913
VIGO

DV911
NOTO

DV909
TOKIO

DV905
RYM

DV903
TAY

DV901
VERTIGO

 **con serratura**
with lock
con cerradura
avec serrure
mit Schloss
com fechadura

T **vetro temperato**
tempered glass
cristal templado
verre trempé
Gehärtetes glas
vidro temperado

 **articolo non in pronta consegna. Per la disponibilità contattare l'ufficio commerciale**
item not in prompt delivery. Please contact the commercial department for checking availability
producto no disponible en stock. Para la disponibilidad contactar con el departamento comercial
article non disponible en stock. Merci de contacter le service commercial pour vérifier la disponibilité
Dieses Produkt ist nicht sofort lieferbar. Setzen Sie sich mit unserem Handelsbüro in Verbindung für die Warenverfügbarkeit
produtos não pronta entrega. Acerca da disponibilidade, contactar o sector comercial

 **fino ad esaurimento**
until exhaustion
hasta que se agoten
soumises à disponibilité
bis Erschöpfung
até à exaustão

 **allunghi montabili anche in posizione centrale sui tavoli scrivania L.160 - 180 - 200**
tables suitable even for central extensions on desks L.160 - 180 - 200
alas que se pueden montar también en posición central con mesas L. 160 - 180 - 200
retours adaptés également à une jonction centrée pour les bureaux L.160 - 180 - 200
Verlängerungen können auch an der mittlere Position der Tische B. 160 - 180 - 200 fixiert werden
extensões de encaixe também na posição central sobre mesas escritaninhas, L. 160 - 180 - 200

DV901 Vertigo

Finiture - finishes - acabados - finitions - farben - acabamentos

V01 M1 **Piani di lavoro in melaminico sp. 18 mm**
 Melamine worktops 18 mm thick
 Sobres de trabajo en melamina 18 mm de grosor
 Plans de travail en melaminé ép. 18 mm
 Tischplatten aus Melamin St. 18 mm
 Planos de trabalho em melaminico esp. 18 mm

RC

Rovere chiaro
 Light oak
 Roble claro
 Chêne clair
 Eiche hell
 Carvalho claro

NM

Noce "Maroncelli"
 Walnut "Maroncelli"
 Nogal "Maroncelli"
 Noyer "Maroncelli"
 Nussbaum "Maroncelli"
 Nogueira "Maroncelli"

RS

Rovere scuro
 Dark oak
 Roble oscuro
 Chêne foncé
 Eiche dunkel
 Carvalho escuro

RM

Rovere moro
 Dark oak
 Roble oscuro
 Chêne foncé
 Eiche dunkel
 Carvalho escuro

RT

Rovere tabacco
 Tobacco oak
 Roble tabaco
 Chêne tabac
 Eiche tabak
 Carvalho tabacco

V01 M2 **Piani di lavoro in melaminico sp. 18 mm**
 Melamine worktops 18 mm thick
 Sobres de trabajo en melamina 18 mm de grosor
 Plans de travail en melaminé ép. 18 mm
 Tischplatten aus Melamin St. 18 mm
 Planos de trabalho em melaminico esp. 18 mm

NO

Nero opaco
 Matt black
 Negro mate
 Noir mat
 Schwarz matt
 Preto opaco

V01 L **Piani di lavoro in laminato sp. 18 mm**
 Laminate work tops 18 mm
 Sobres de trabajo en laminado 18 mm de grosor
 Plateaux en laminé ép. 18 mm
 Tischplatten aus Laminat St. 18 mm
 Plano de trabalho em laminado de espessura de 18 mm

WL

Bianco lucido
 Polished white
 Blanco brillo
 Blanc luisant
 Weiß hochglanz
 Branco brilhante

V01 VW **Piani di lavoro in vetro temperato retrolaccato sp. 10 mm**
 Rear-lacquered gloss tempered tops 10 mm thick
 Sobre de trabajo en cristal retrolacado y templado 10 mm de grosor
 Plans de travail en verre retro-lacqué trempé ép. 10 mm
 Rückseite lackiertem Ätzglas/Cristal aus Sicherheitsglas St. 10 mm
 Plano de trabalho em vidro temperado espessura de 10 mm

VW

Bianco
 White
 Blanco
 Blanc
 Weiss
 Branco

V01 VAN **Piani di lavoro in vetro temperato retrolaccato acidato sp. 10 mm**
 Worktops rear-lacquered acetated tempered tops 10 mm thick
 Sobre de trabajo en cristal retrolacado y ácido templado 10 mm de grosor
 Plans de travail en verre retro-lacqué acide trempé ép. 10 mm
 Tischplatte auslackiertem Ätzglas/Cristal aus Sicherheitsglas St. 10 mm
 Plano de trabalho em vidro fosco temperado espessura de 10 mm

VAN

Nero
 Black
 Negro
 Noir
 Schwarz
 Preto

V01 C **Piani di lavoro in cuoio con cuciture sp 20 mm**
 Worktops in leather with stitches, 20 mm thick
 Sobre en cuero cosido de 20 mm de grosor/espesor
 Plateaux en cuir avec coutures, 20 mm épaisseur
 Leder Tischplatten mit Nähten, 20 mm Stärke
 Plano de trabalho revestido com couro natural com costuras espessura 20 mm

CBI

Cuoio bianco
 White hard leather
 Cuero blanco
 Cuir blanc
 Weiß Leder
 Couro branco

CNE

Cuoio nero
 Black hard leather
 Cuero negro
 Cuir noir
 Schwarz Leder
 Couro preto

CTM

Cuoio testa di moro
 Dark brown hard leather
 Cuero marrón oscuro
 Cuir marron foncé
 Leder Dunkelbraun
 Couro castanho escuro

V01 GRES **Piano scrivania in vetro temprato trasparente sp. 8 mm, accoppiato con piano in gres porcellanato sp. 6 mm**
 Desktop in 8 mm thick transparent tempered glass, matched with a 6 mm thick porcelain stoneware top
 Encimera de cristal templado transparente de 8 mm de grosor, unida a una tapa de gres porcelánico de 6 mm de grosor
 Plan de travail en verre trempé transparent de 8 mm d'ép., assorti d'un plateau en grès porcelaine de 6 mm d'ép.
 Arbeitsplatte aus 8 mm dickem, transparentem, gehärtetem Glas in Kombination mit einer 6 mm dicken Platte aus Feinsteinzeug
 Tampo de trabalho em vidro transparente temperado de 8 mm de espessura, combinado com uma placa de grés porcelânico de 6 mm de espessura

VGB

Bianco "Extra White"
 White "Extra White"
 Blanco "Extra White"
 Blanc "Extra White"
 Weiß "Extra White"
 Branco "Extra White"

VGN

Nero "Marquina"
 Black "Marquina"
 Negro "Marquina"
 Noir "Marquina"
 Schwarz "Marquina"
 Preto "Marquina"

DV901 Vertigo

Finiture - finishes - acabados - finitions - farben - acabamentos

V02 **Strutture metalliche**
 Metal structures
 Estructuras metálicas
 Structures métalliques
 Metallstrukturen
 Estruturas metálicas

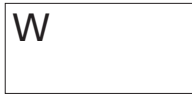

Bianco
 White
 Blanco
 Blanc
 Weiss
 Branco



Alluminio
 Aluminium
 Aluminio
 Aluminium
 Aluminium
 Aluminio



Antracite
 Anthracite
 Antracita
 Anthracite
 Anthrazit
 Antracite

V13 **Top access Alluminio**
 Top access Aluminium
 Top access Aluminio
 Top access Aluminium
 Top Access Aluminium
 Top access Aluminio



Bianco
 White
 Blanco
 Blanc
 Weiss
 Branco



Alluminio
 Aluminium
 Aluminio
 Aluminium
 Aluminium
 Aluminio



Nero anodizzato
 Anodized black
 Negro anodizado
 Noir anodisé
 eloxiert Schwarz
 Preto anodizado

V02 **Struttura metallica (gambone in metallo con base)**
 Metallic structure (metal column base)
 Estructura metálica (pata cilíndrica de metal)
 Structure métallique (pied-colonne en métal avec base)
 Metall struktur (Metallsäule mit Säulenfuß)
 Estrutura metálica (pedestal em metal cor com base)



Alluminio "anodizzato"
 "anodized" aluminium
 aluminio "anodizado"
 aluminium "anodisé"
 "eloxiert" Aluminium
 alumínio "anodizado"



gambone alluminio / basamento inox
 aluminium column / stainless steel base

Top access mobili di servizio (solo in colore alluminio)
 Top access Aluminium (only in aluminum colour)
 Top access Aluminio (solo en color aluminio)
 Top access Aluminium (uniquement en couleur aluminium)
 Top Access Aluminium (nur in Aluminium)
 Top access Aluminio (somente na cor aluminio)



Alluminio
 Aluminium
 Aluminio
 Aluminium
 Aluminium
 Aluminio

DV901 Vertigo

Finiture - finishes - acabados - finitions - farben - acabamentos

V09	Modesty panel Modesty panel Faldón Voile de fond Knieblende Modesty panel				
	M1	WN	HH	RC	NM
	Melaminico sp. 18 mm Melamine 18 mm thick Melamina 18 mm de grosor Melaminé ép. 18 Mm épaisseur Melamin st. 18 Mm Melamínico esp. 18 Mm	Bianco White Blanco Blanc Weiss Branco	Alluminio Aluminium Aluminio Aluminium Aluminium Aluminio	Rovere chiaro Light oak Roble claro Chêne clair Eiche hell Carvalho claro	Noce "Maroncelli" Walnut "Maroncelli" Nogal "Maroncelli" Noyer "Maroncelli" Nussbaum "Maroncelli" Nogueira "Maroncelli"
		RS	RM	RT	
		Rovere scuro Dark oak Roble oscuro Chêne foncé Eiche dunkel Carvalho escuro	Rovere moro Dark oak Roble oscuro Chêne foncé Eiche dunkel Carvalho escuro	Rovere tabacco Tobacco Oak Roble tabaco Chêne tabac Eiche tabak Carvalho tabaco	
	M2	NO	L	WL	
	Melaminico sp. 18/25 mm Melamine 18/25 mm thick Melamina 18/25 mm de grosor Melaminé ép. 18/25 mm Melamin st. 18/25 mm Melamínico esp. 18/25 mm	Nero opaco Matt black Negro mate Noir mat Schwarz matt Preto opaco	Laminato sp. 18 mm Laminate 18 mm thick Laminado 18 mm de grosor Laminé ép. 18 mm Laminat st. 18 mm Laminado de espessura de 18 mm	Bianco lucido Polished white Blanco brillo Blanc luisant Weiß hochglanz Branco brilhante	
	C	CBI	CNE	CTM	
	Cuoio con cuciture sp. 20 mm Leather with stitches, 20 mm thick Cuero cosido de 20 mm de grosor Cuir avec coutures, ép. 20 mm Leder mit Nähten, 20 mm Stärke Couro com costuras esp. 20 mm	Cuoio bianco White hard leather Cuero blanco Cuir blanc Weiß Leder Couro branco	Cuoio nero Black hard leather Cuero negro Cuir noir Schwarz Leder Couro preto	Cuoio testa di moro Dark brown hard leather Cuero marrón oscuro Cuir marron foncé Leder Dunkelbraun Couro castanho escuro	

DV913 VIGO
DV911 NOTO
DV909 TOKIO
DV905 RYM
DV903 TAY
DV901 VERTIGO

DV901 Vertigo

Finiture - finishes - acabados - finitions - farben - acabamentos

V04 Mobile di servizio / cassettiera per vano interno mobile di servizio e ripiano
 Service unit / pedestal for inside service unit and shelf
 Mueble auxiliar / cajonera para hueco interior meuble auxiliar y balda
 Desserte / caisson pour compartiment intérieur desserte et tablette
 Beistellschrank / Schubladenelement für internes Beistellmöbel und Einlegeboden
 Móvel de serviço / gaveteiro para compartimento interno móvel de serviço e prateleira

M1

Melaminico sp. 18/25 mm

Melamine 18/25 mm thick
 Melamina 18/25 mm de grosor
 Melaminé ép. 18/25 mm
 Melamin st. 18/25 mm
 Melaminico esp. 18/25 mm

WN

Bianco opaco

Matt white
 Blanco opaco
 Blanc mat
 Mattweiß
 Branco fosco

RC

Rovere chiaro

Light oak
 Roble claro
 Chêne clair
 Eiche hell
 Carvalho claro

NM

Noce "Maroncelli"

Walnut "Maroncelli"
 Nogal "Maroncelli"
 Noyer "Maroncelli"
 Nussbaum "Maroncelli"
 Nogueira "Maroncelli"

RS

Rovere scuro

Dark oak
 Roble oscuro
 Chêne foncé
 Eiche dunkel
 Carvalho escuro

RM

Rovere moro

Dark oak
 Roble oscuro
 Chêne foncé
 Eiche dunkel
 Carvalho escuro

RT

Rovere tabacco

Tobacco oak
 Roble tabaco
 Chêne tabac
 Eiche tabak
 Carvalho tabaco

M2

Melaminico sp. 18/25 mm

Melamine 18/25 mm thick
 Melamina 18/25 mm de grosor
 Melaminé ép. 18/25 mm
 Melamin st. 18/25 mm
 Melaminico esp. 18/25 mm

NO

Nero opaco

Matt black
 Negro mate
 Noir mat
 Schwarz matt
 Preto opaco

L

Laminato sp. 18/25 mm

Laminate 18/25 mm thick
 Laminado 18/25 mm de grosor
 Laminé ép. 18/25 mm
 Laminat st. 18/25 mm
 Laminado esp. 18/25 mm

WL

Bianco lucido

Polished white
 Blanco brillo
 Blanc luisant
 Weiß hochglanz
 Branco brilhante

V81 Mobile di servizio - LATO SINISTRO (SX) o LATO DESTRO (DX)
 Service unit - LEFT HAND (SX) or RIGHT HAND (DX)
 Mueble auxiliar - LADO IZQUIERDO (SX) o LADO DERECHO (DX)
 Desserte - CÔTÉ GAUCHE (SX) ou CÔTÉ DROITE (DX)
 Beistellschrank - LINKS (SX) oder RECHT (DX)
 Móvel de serviço - LATERAL ISQUIERDA (SX) ou LATERAL DIREITO (DX)

SX/L

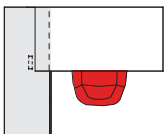

DX/R

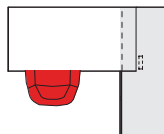

V10 Cassetti interni disponibili in melaminico rivestiti in PVC (*) o metallico ()**
 Inside drawers available with melamine coated with PVC (*) or metal (**)
 Interior de los cajones disponibles en melamina revestida en PVC (*) o en metal (**)
 Intérieur tiroir disponibles en mélaminé revêtus de PVC (*) ou métal (**)
 Interne Schublade verfügbar in folgenden Ausführungen aus Melamin PVC Spanplatte (*) oder Metall (**)
 Gavetas internas disponíveis em melaminico revestidas em PVC (*) ou metálico (**)

DFT *

Grigio chiaro (standard)

Light grey (standard)
 Gris claro (standard)
 Gris clair (standard)
 Hellgrau (standard)
 Cinza claro (standard)

AL01 **

Alluminio

Aluminium
 Alumínio
 Aluminium
 Aluminium
 Alumínio

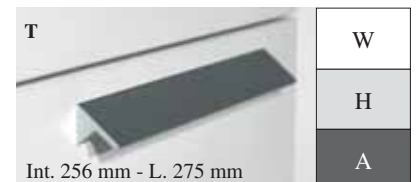
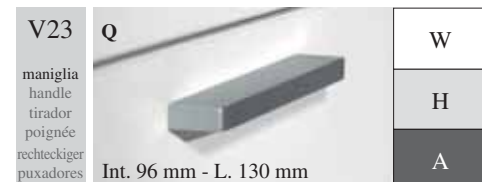

DV901 Vertigo









V01 piani
worktops

M1	RC	NM	RS	RM	RT
M2	NO				

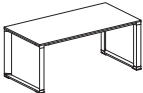
L	WL
---	----

C	CBI	CNE	CTM
---	-----	-----	-----

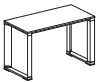
V02 gambe legs	W	H	A
-------------------	---	---	---

TAVOLI SCRIVANIA DESKS	L. W.	P. D.	H. H.	CODICE CODE	V01 / V02				Kg. lb	m ³ ft ³	n. no.
					M1	M2	L	C			
 <p>tavolo scrivania desk mesa despacho table de bureau Schreibtisch mesa escritivaninha</p>	160 63"	80 31 1/2"	75 29 5/8"	901.TS.02.16	1.008	1.060	1.152	1.900	39,40 86,87	0,125 4,41	4 4
	180 70 7/8"	90 35 1/2"	75 29 5/8"	901.TS.03.18	1.046	1.116	1.238	2.072	44,20 97,46	0,148 5,22	4 4
	200 78 3/4"	90 35 1/2"	75 29 5/8"	901.TS.03.20	1.060	1.125	1.274	2.216	50,80 112,01	0,156 5,51	4 4
											
 <p>tavolo scrivania con basi desk with bases mesa despacho con bases table de bureau avec bases Schreibtisch mit Basen mesa escritivaninha com bases</p>	180 70 7/8"	90 35 1/2"	75 29 5/8"	901.TS.48.18	1.218	1.288	1.410	2.244	48,50 106,94	0,235 8,30	3 3
	200 78 3/4"	90 35 1/2"	75 29 5/8"	901.TS.48.20	1.232	1.297	1.446	2.388	55,10 121,49	0,243 8,58	3 3
											
 <p>tavolo dattilo typing table ala para máquina de escribir table dactylo Schreibmaschinentisch mesa para teclado</p>	120 47 1/4"	60 23 5/8"	75 29 5/8"	901.TS.44.12	903	940	976	1.414	30,00 66,15	0,099 3,49	4 4
											
 <p>tavolo dattilo con basi typing table with bases ala para máquina de escribir con bases table dactylo avec bases Schreibmaschinentisch mit Basen mesa para teclado com bases</p>	120 47 1/4"	60 23 5/8"	75 29 5/8"	901.TS.50.12	1.075	1.112	1.148	1.586	33,70 74,30	0,135 4,77	3 3
											

DV913 VIGO
DV911 NOTO
DV909 TOKIO
DV905 RYM
DV903 TAY
DV901 VERTIGO

DV901 Vertigo

V01 piani
worktops

M1	RC	NM	RS	RM	RT
M2	NO				

L	WL
---	----

C	CBI	CNE	CTM
---	-----	-----	-----

V02 gambe legs	W	H	A
-------------------	---	---	---

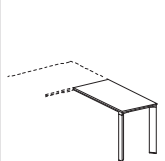
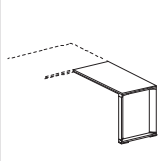
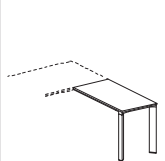
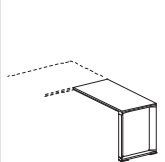

TAVOLI DATILO TYPING TABLES	L. W.	P. D.	H. H.	CODICE CODE	V01 / V02				Kg. lb	m ³ ft ³	n. no.	
					M1	M2	L	C				
 <p>Dx/R Sx/L</p>	DX/R	120 47 1/4"	60 23 5/8"	75 29 5/8"	901.TD.30.12	668	705	741	1.179	26,70 58,87	0,099 3,49	4 4
	SX/L	120 47 1/4"	60 23 5/8"	75 29 5/8"	901.TD.32.12	668	705	741	1.179	26,70 58,87	0,099 3,49	4 4
<p>allungo per scrivania L. 160 -180 cm</p> <p>extension table for desk L. 160 - 180 cm</p> <p>ala para mesa L. 160 - 180 cm</p> <p>retour pour bureau L. 160 -180 cm</p> <p>Anschluss für Schreibtisch B. 160 - 180 cm</p> <p>extensão para escrivaninha L. 160 - 180 cm</p>												
 <p>Dx/R Sx/L</p>	DX/R	120 47 1/4"	60 23 5/8"	75 29 5/8"	901.TD.31.12	776	813	849	1.287	30,00 66,15	0,149 5,26	4 4
	SX/L	120 47 1/4"	60 23 5/8"	75 29 5/8"	901.TD.33.12	776	813	849	1.287	30,00 66,15	0,149 5,26	4 4
<p>allungo per scrivania L. 160 -180 cm</p> <p>extension table for desk L. 160 - 180 cm</p> <p>ala para mesa L. 160 - 180 cm</p> <p>retour pour bureau L. 160 -180 cm</p> <p>Anschluss für Schreibtisch B. 160 - 180 cm</p> <p>extensão para escrivaninha L.160 - 180 cm</p>												
 <p>160-180-200</p> <p>200</p> <p>200</p>	◇	120 47 1/4"	60 23 5/8"	75 29 5/8"	901.TD.26.12	668	705	741	1.179	26,70 58,87	0,099 3,49	4 4
<p>allungo destro/sinistro per scrivania L. 200 cm o centrale per scrivania L.160 - 180 - 200 cm</p> <p>rh/lh extension table for desk L. 200 cm or central for desk L.160 - 180 - 200 cm</p> <p>ala derecha/izquierda para mesa L. 200 cm o central para mesa L. 160 - 180 - 200 cm</p> <p>retour droit/gauche pour bureau L. 200 cm ou central pour bureau L. 160 - 180 - 200 cm</p> <p>Anschluss für Schreibtisch B. 200 cm oder für Zentral- schreibtisch B. 160 - 180 - 200 cm, rechts/links</p> <p>extensão direito/esquerdo para escrivaninha L. 200 cm ou central para escrivaninha L. 160 - 180 - 200 cm</p>												
 <p>160-180-200</p> <p>200</p> <p>200</p> <p>Dx/R Sx/L</p>	◇	120 47 1/4"	60 23 5/8"	75 29 5/8"	901.TD.27.12	776	813	849	1.287	30,00 66,15	0,149 5,26	4 4
<p>allungo destro/sinistro per scrivania L. 200 cm o centrale per scrivania L. 160 - 180 - 200 cm</p> <p>rh/lh extension table for desk L. 200 cm or central for desk L. 160 - 180 - 200 cm</p> <p>ala derecha/izquierda para mesa L. 200 cm o central para mesa L. 160 - 180 - 200 cm</p> <p>retour droit/gauche pour bureau L.200 ou central pour bureau L. 160 - 180 - 200 cm</p> <p>Anschluss für Schreibtisch B. 200 cm oder für Zentral- schreibtisch B. 160 - 180 - 200 cm, rechts/links</p> <p>extensão direito/esquerdo para escrivaninha L. 200 cm ou central para escrivaninha L. 160 - 180 - 200 cm</p>												

DV901 Vertigo

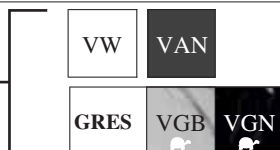
V01 piani
worktops

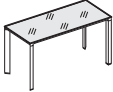
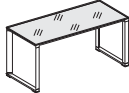

V02 gambe legs	W	H	A
-------------------	---	---	---

TAVOLI SCRIVANIA / TAVOLI DATTILO DESKS / TYPING TABLES	L. W.	P. D.	H. H.	CODICE CODE	V01 / V02			Kg. lb	m ³ ft ³	n. no.	
					VW	VAN	GRES				
	T	160 63"	80 31 1/2"	74,5 29 3/8"	901.TV.15.16	1.479	1.539	-	73,60 162,28	0,125 4,41	4 4
	T	180 70 7/8"	90 35 1/2"	74,5 29 3/8"	901.TV.01.18	1.635	1.722	4.397	71,20 156,99	0,136 4,80	4 4
	T	200 78 3/4"	90 35 1/2"	74,5 29 3/8"	901.TV.01.20	1.745	2.037	4.593	75,80 167,13	0,144 5,08	4 4
tavolo scrivania in vetro retrolaccato o gres porcellanato desk with rear-lacquered glass or porcelain stoneware worktop mesa despacho en cristal retrolacado o gres porcelánico table de bureau en verre rétro-laqué ou grès finition marbre Schreibtisch aus Glas, auf der Rückseite lackiert, oder Arbeitsplatten in Porzellan Steingut mesa escritivanha em vidro retrolacado ou grés porcelânico											
	T	180 70 7/8"	90 35 1/2"	74,5 29 3/8"	901.TV.17.18	1.807	1.894	4.569	75,50 166,47	0,223 7,87	3 3
	T	200 78 3/4"	90 35 1/2"	74,5 29 3/8"	901.TV.17.20	1.917	2.209	4.765	80,10 176,62	0,231 8,16	3 3
tavolo scrivania in vetro retrolaccato o gres porcellanato con basi desk with rear-lacquered glass or porcelain stoneware worktop with bases mesa despacho en cristal retrolacado o gres porcelánico con bases table de bureau en verre rétro-laqué ou grès finition marbre avec bases Schreibtisch aus Glas, auf der Rückseite lackiert mit Basen, oder Arbeitsplatten in Porzellan Steingut mesa escritivanha em vidro retrolacado ou grés porcelânico											
	T	120 47 1/4"	60 23 5/8"	74,5 29 3/8"	901.TV.16.12	1.227	1.263	2.274	37,20 82,02	0,099 3,49	4 4
	tavolo dattilo in vetro retrolaccato o gres porcellanato typing table with rear-lacquered glass or porcelain stoneware worktop ala para máquina de escribir en cristal retrolacado o gres porcelánico table dactylo en verre rétro-laqué ou grès finition marbre Schreibmaschinentisch aus Glas, auf der Rückseite lackiert, oder Arbeitsplatten in Porzellan Steingut mesa para teclado em vidro retrolacado ou grés porcelânico										
	T	120 47 1/4"	60 23 5/8"	74,5 29 3/8"	901.TV.19.12	1.399	1.435	2.446	40,90 90,18	0,135 4,77	3 3
	tavolo dattilo in vetro retrolaccato o gres porcellanato con basi typing table with rear-lacquered glass or porcelain stoneware worktop with bases ala para máquina de escribir en cristal retrolacado o gres porcelánico con bases table dactylo en verre rétro-laqué ou grès finition marbre avec bases Schreibmaschinentisch aus Glas, auf der Rückseite lackiert mit Basen mesa para teclado em vidro retrolacado ou grés porcelânico										

DV913 VIGO
DV911 NOTO
DV909 TOKIO
DV905 RYM
DV903 TAY
DV901 VERTIGO

DV901 Vertigo

V01 piani
worktops

VW	VAN
GRES	VGB VGN

V02 gambe legs	W	H	A
-------------------	---	---	---

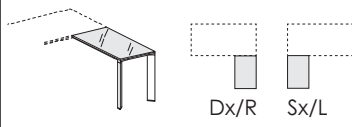
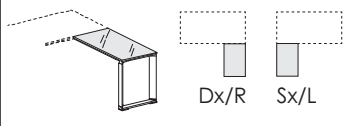
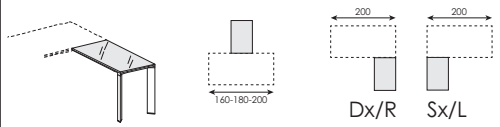
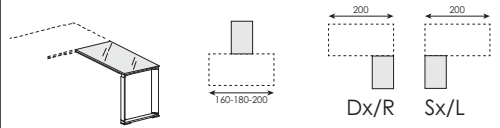
TAVOLI DATTELO TYPING TABLES	L. W.	P. D.	H. H.	CODICE CODE	V01 / V02			Kg. lb	m³ ft³	n. no.	
					VW	VAN	GRES				
	T DX/R	120 47 1/4"	60 23 5/8"	75 29 5/8"	901.TV.21.12	992	1.028	2.039	33,90 74,74	0,099 3,49	4 4
	T SX/L	120 47 1/4"	60 23 5/8"	75 29 5/8"	901.TV.23.12	992	1.028	2.039	33,90 74,74	0,099 3,49	4 4
<p>allungo in vetro retrolaccato per scrivania L. 160 -180 cm</p> <p>extension table with rear-lacquered glass for desk L. 160 - 180 cm</p> <p>ala en cristal retrolacado para mesa L. 160 - 180 cm</p> <p>retour verre retro laqué pour bureau L. 160 - 180 cm</p> <p>Anschluss aus Glas, auf der Rückseite lackiert für Schreibtisch B. 160 - 180 cm</p> <p>extensão em vidro retrolacado para escrivaninha L. 160 - 180 cm</p>											
	T DX/R	120 47 1/4"	60 23 5/8"	75 29 5/8"	901.TV.22.12	1.100	1.136	2.147	37,20 82,02	0,149 5,26	4 4
	T SX/L	120 47 1/4"	60 23 5/8"	75 29 5/8"	901.TV.24.12	1.100	1.136	2.147	37,20 82,02	0,149 5,26	4 4
<p>allungo in vetro retrolaccato per scrivania L. 160 -180 cm</p> <p>extension table with rear-lacquered glass for desk L. 160 - 180 cm</p> <p>ala en cristal retrolacado para mesa L. 160 - 180 cm</p> <p>retour verre retro laqué pour bureau L. 160 - 180 cm</p> <p>Anschluss aus Glas, auf der Rückseite lackiert für Schreibtisch B. 160 - 180 cm</p> <p>extensão em vidro retrolacado para escrivaninha L. 160 - 180 cm</p>											
	T	120 47 1/4"	60 23 5/8"	75 29 5/8"	901.TV.04.12	992	1.028	2.039	33,90 74,74	0,099 3,49	4 4
	<p>allungo destro/sinistro in vetro retrolaccato per scrivania L. 200 cm o centrale per scrivania L. 160 - 180 - 200 cm</p> <p>rh/lh extension table with rear-lacquered glass for desk L. 200 cm or central for desk L. 160 - 180 - 200 cm</p> <p>ala derecha/izquierda en cristal retrolacado para mesa L. 200 cm o central para mesa L. 160 - 180 - 200 cm</p> <p>retour droit/gauche verre retro laqué pour bureau L. 200 cm ou central pour bureau L. 160 - 180 - 200 cm</p> <p>Anschluss aus Glas, auf der Rückseite lackiert für Schreibtisch B. 200 cm oder für Zentralschreibtisch B. 160 - 180 - 200 cm, rechts/links</p> <p>extensão direito/esquerdo em vidro retrolacado para escrivaninha L. 200 cm ou central para escrivaninha L. 160 - 180 - 200 cm</p>										
	T	120 47 1/4"	60 23 5/8"	75 29 5/8"	901.TV.20.12	1.100	1.136	2.147	37,20 82,02	0,149 5,26	4 4
	<p>allungo destro/sinistro in vetro retrolaccato per scrivania L. 200 cm o centrale per scrivania L. 160 - 180 - 200 cm</p> <p>rh/lh extension table with rear-lacquered glass for desk L. 200 cm or central for desk L. 160 - 180 - 200 cm</p> <p>ala derecha/izquierda en cristal retrolacado para mesa L. 200 cm o central para mesa L. 160 - 180 - 200 cm</p> <p>retour droit/gauche verre retro laqué pour bureau L. 200 cm ou central pour bureau L. 160 - 180 - 200 cm</p> <p>Anschluss aus Glas, auf der Rückseite lackiert für Schreibtisch B. 200 cm oder für Zentralschreibtisch B. 160 - 180 - 200 cm, rechts/links</p> <p>extensão direito/esquerdo em vidro retrolacado para escrivaninha L. 200 cm ou central para escrivaninha L. 160 - 180 - 200 cm</p>										

DV901 Vertigo

V01 piani
worktops

M1	RC	NM	RS	RM	RT
M2	NO				

L	WL
---	----

C	CBI	CNE	CTM
---	-----	-----	-----

V02 gambe legs	W	H	A
-------------------	---	---	---

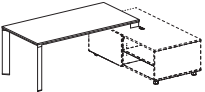
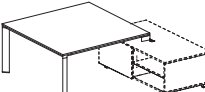
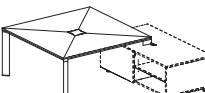
TAVOLI INTEGRABILI CON MOBILE DI SERVIZIO INTEGRABLE DESKS FOR SERVICE UNITS	L. W.	P. D.	H. H.	CODICE CODE	V01 / V02				Kg. lb	m ³ ft ³	n. no.
					M1	M2	L	C			
 <p>tavolo scrivania per integrazioni con mobile di servizio desk for Integration integration with service units mesa despacho para la integración con mueble auxiliar Table de bureau pour l'intégration avec desserte avec desserte Schreibtisch zur Integration mit Beistellmöbel mit Beistellmöbel mesa escritivaninha para integração com móvel de serviço</p>	180 70 7/8"	90 35 1/2"	75 29 5/8"	901.TL.15.18	952	1.022	1.144	1.978	41,80 92,16	0,182 6,43	5 5
	200 78 3/4"	90 35 1/2"	75 29 5/8"	901.TL.15.20	966	1.031	1.180	2.122	48,40 106,72	0,190 6,71	5 5
 <p>tavolo riunioni cm 160x160 per integrazioni con mobile di servizio conference table 160x160 cm for integration with service units mesa de reuniones 160x160 cm para la integración con mueble auxiliar table de réunion 160x160 cm pour l'intégration avec desserte Besprechungstisch 160x160 cm zur Integration mit Beistellmöbel mesa de reunião cm 160x160 para integração com móvel de serviço</p>	DX/R 160 63"	160 63"	75 29 5/8"	901.TL.16.16	1.123	-	1.430	2.564	59,60 131,41	0,207 7,31	5 5
	SX/L 160 63"	160 63"	75 29 5/8"	901.TL.17.16	1.123	-	1.430	2.564	59,60 131,41	0,207 7,31	5 5
 <p>tavolo riunioni cm 160x160 con piano composto, per integrazioni con mobile di servizio right conference table 160x160 cm with composed top, for integration with service units mesa de reuniones 160x160 cm con sobre compuestos para la integración con mueble auxiliar table de réunion 160x160 cm avec plateaux composé pour l'intégration avec desserte Besprechungstisch 160x160 cm mit zusammengesetzter Arbeitsplatte, zur Integration mit Beistellmöbel mesa de reunião cm 160x160 con plano componivel, para integração com móvel de serviço</p>	DX/R 160 63"	160 63"	75 29 5/8"	901.TL.18.16	2.021	-	2.505	3.997	73,20 161,40	0,354 12,50	10 10
	SX/L 160 63"	160 63"	75 29 5/8"	901.TL.19.16	2.021	-	2.505	3.997	73,20 161,40	0,354 12,50	10 10

DV913 VIGO
DV911 NOTO
DV909 TOKIO
DV905 RYM
DV903 TAY
DV901 VERTIGO

DV901 Vertigo

V01 piani worktops	VW	VAN
	GRES	VGB VGN

V02 gambe legs	W	H	A
-------------------	---	---	---

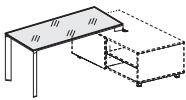
TAVOLI INTEGRABILI CON MOBILE DI SERVIZIO INTEGRABLE DESKS FOR SERVICE UNITS	L. W.	P. D.	H. H.	CODICE CODE	V01 / V02			Kg. lb	m ³ ft ³	n. no.	
					VW	VAN	GRES				
 <p>tavolo scrivania in vetro temperato per integrazioni con mobile di servizio desk with tempered glass top for integration with service units mesa despacho de cristal templado para la integración con mueble auxiliar Table de bureau pour l'intégration avec desserte avec desserte Schreibtisch aus gehärtetem Glas zur Integration mit Beistellmöbel mesa escrivaninha em vidro temperado para integração com móvel de serviço</p>	T	180 70 7/8"	90 35 1/2"	74,5 29 3/8"	901.TV.11.18	1.541	1.628	4.303	68,80 151,70	0,170 6,00	5 5
	T	200 78 3/4"	90 35 1/2"	74,5 29 3/8"	901.TV.11.20	1.651	1.943	4.499	73,40 161,84	0,178 6,28	5 5

V01 piani worktops	VW	VAN
-----------------------	----	-----

V02 gambe legs	W	H	A
-------------------	---	---	---

V13 top access top access	W	H	N
------------------------------	---	---	---

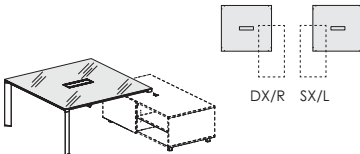
TAVOLI INTEGRABILI CON MOBILE DI SERVIZIO INTEGRABLE DESKS FOR SERVICE UNITS	L. W.	P. D.	H. H.	CODICE CODE	V01 / V02 / V13		Kg. lb	m ³ ft ³	n. no.	
					VW	VAN				
 <p>tavolo riunioni in vetro cm 160x160 per integrazioni con mobile di servizio glass conference table 160x160 cm for integration with service units mesa de reuniones en cristal retrolacado 160x160 cm para la integración con mueble auxiliar table de réunion en verre 60x160 cm pour l'intégration avec desserte Besprechungstisch aus Glas 160x160 cm zur Integration mit Beistellmöbel mesa de reunião em vidro cm 160x160 para integração com móvel de serviço</p>	T	DX/R 160 63"	160 63"	74,5 29 3/8"	901.TV.22.16	2.288	2.597	116,40 256,66	0,214 7,56	6 6
	T	SX/L 160 63"	160 63"	74,5 29 3/8"	901.TV.23.16	2.288	2.597	116,40 256,66	0,214 7,56	6 6

1 Top access incluso
1 Top access included
1 Top access incluido
1 Top access compris
1 Top Access Inbegriffen
1 Top access incluso
Cod. 300.AC.20.04
L.44,7 cm - W. 17 1/2"

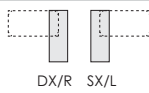
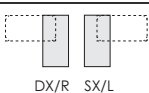

DV901 Vertigo

V04 mobile di servizio service unit	M1	WN	RC	NM	RS	RM	RT	V02 gambe legs	W	H	A
	M2	NO				L	WL	V81 verso hand	Sx	Dx	

MOBILI DI SERVIZIO SERVICE UNITS	MSF. SUF.	L. W.	P. D.	H. H.	CODICE CODE	V04 V02 V81	Kg. lb	m ³ ft ³	n. no.
 mobile di servizio cm 180x66 service unit cm 180x66 mueble auxiliar 180x66 cm desserte 180x66 cm Beistellmöbel 180x66 cm móvel de serviço cm 180x66	M1	180 70 7/8"	66 26"	63 24 7/8"	901.MS.6M.18	1.257	115,10 253,79	0,239 8,44	5 5
	M2	180 70 7/8"	66 26"	63 24 7/8"	901.MS.6M.18	1.543	115,10 253,79	0,239 8,44	5 5
	L	180 70 7/8"	66 26"	63 24 7/8"	901.MS.6W.18	2.008	115,10 253,79	0,239 8,44	5 5
 mobile di servizio cm 180x92,5 service unit cm 180x92,5 mueble auxiliar 180x92,5 cm desserte 180x92,5 cm Beistellmöbel 180x92,5 cm móvel de serviço cm 180x92,5	M1	180 70 7/8"	92,5 36 1/2"	63 24 7/8"	901.MS.9M.18	1.487	150,80 332,51	0,318 11,23	6 6
	M2	180 70 7/8"	92,5 36 1/2"	63 24 7/8"	901.MS.9M.18	1.856	150,80 332,51	0,318 11,23	6 6
	L	180 70 7/8"	92,5 36 1/2"	63 24 7/8"	901.MS.9W.18	2.434	150,80 332,51	0,318 11,23	6 6

V10 cassetti interni metal drawers	PVC	DFT
	MET	AL01

V04 cassetiere pedestals	M1	WN	RC	NM	RS	RM	RT
	M2	NO					
	L	WL					

V23 maniglia handle	Q		V		W
	T				H
					A



CASSETTIERE PER MOBILI DI SERVIZIO PEDESTALS FOR SERVICE UNITS	L. W.	P. D.	H. H.	CODICE CODE	V10-PVC			Kg. lb	m ³ ft ³	n. no.	
					M1	M2	L				
 cassetiera 3 cassetti per vano interno mobile di servizio + ripiano 3 drawers pedestal for inside service unit + shelf cajonera 3 cajones para hueco interior mueble auxiliar + balda caisson 3 tiroirs pour compartiment intérieur desserte + tablette Schubladenelement mit 3 Schüben für internes Beistellmöbel + Einlegeboden gaveteiro 3 gavetas para compartimento interno móvel de serviço + prateleira	FO	42 16 1/2"	55 21 3/4"	48 21 3/4"	550.CM.01.04	325	391	414	27,24 60,06	0,167 5,90	4 4
						V10-MET					
						374	429	452			

DV901 Vertigo

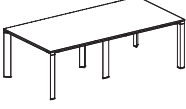
V01 piani worktops	M1	RC	NM	RS	RM	RT	L	WL	V02 gambe legs	W	H	A
	M2	NO					C	CBI				

TAVOLI RIUNIONE CONFERENCE TABLES	L. W.	P. D.	H. H.	CODICE CODE	V01 / V02				Kg. lb	m³ ft³	n. no.
					M1	M2	L	C			
 <p>tavolo riunioni cm 100x100 conference table cm 100x100 mesa de reuniones de 100x100 cm table de réunion 100x100 cm Besprechungstisch 100x100 cm mesa reunião cm 100X100</p>	100 39 3/8"	100 39 3/8"	75 29 5/8"	901.TR.42.10	919	969	1.029	1.518	30,20 66,59	0,111 3,92	3 3
 <p>tavolo riunioni cm 240x120 conference table cm 240x120 mesa de reuniones de 240x120 cm table de réunion 240x120 cm Besprechungstisch 240x120 cm mesa de reunião cm 240x120</p>	240 94 1/2"	120 47 1/4"	75 29 5/8"	901.TR.41.24	1.734	1.983	2.203	3.728	71,80 158,31	0,235 8,30	8 8

V01 piani worktops	VW	VAN	
	GRES	VGB	VGN



TAVOLI RIUNIONE CONFERENCE TABLES	L. W.	P. D.	H. H.	CODICE CODE	V01			Kg. lb	m³ ft³	n. no.	
					VW	VAN	GRES				
 <p>tavolo riunioni circolare in vetro o gres porcellanato su gambone in metallo con base finitura inox round meeting table with glass or stoneware top and with metal column, base inox finish mesa de reuniones redonda en cristal o en gres porcelánico con pata cilíndrica de metal y con base cuadrada acabado inox table de réunion ronde en verre ou en grès finition marbre, sur pied-colonne en métal avec basec arrée finiton inox runder Besprechungstisch aus Glas oder Porzellan Steingut, auf Metallsäule mit mit quadratischem Fuß Edelstahlfarbig mesa de reunião circular em vidro o grés porcelánico, sobre pedestal em metal cor alumínio com base quadrada, acabamento inox</p>	100 39 3/8"	100 39 3/8"	74,5 29 3/8"	901.TV.14.10	1.031	1.161	2.444	70,50 155,45	0,143 5,05	4 4	
					 <p>gambone alluminio / basamento inox aluminium column / stainless steel base</p>						

DV901 Vertigo

V01 piani
worktops

VW	VAN	
GRES	VGB	VGN

V02 gambe legs	W	H	A
V13 top access top access	W	H	N

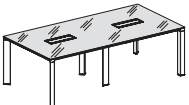
TAVOLI RIUNIONE CONFERENCE TABLES	L. W.	P. D.	H. H.	CODICE CODE	V01 / V02 / V13			Kg. lb	m ³ ft ³	n. no.	
					VW	VAN	GRES				
 <p>tavolo riunioni circolare in vetro retrolaccato o gres porcellanato, su gambone in metallo con base round conference table in rear-lacquered glass or porcelain stoneware worktop, with metal column base mesa de reuniones redonda en cristal retrolacado ou en gres porcelánico, con pata cilíndrica de metal table de réunion ronde en verre rétro-laqué ou en grès finition marbre, sur pied-colonne en métal avec base runder Besprechungstisch aus Glas oder Arbeitsplatten in Porzellan Steingut auf Metallsäule mit Säulenfuss mesa de reunião circular em vidro retrolacado ou em grés porcelânico, sobre pedestal em metal cor alumínio com base</p>	T	100 39 3/8"	100 39 3/8"	74,5 29 3/8"	901.TV.15.10	890	1.020	2.303	42,20 93,05	0,029 1,02	3 3
 <p>tavolo riunioni con piano in vetro retrolaccato o gres porcellanato conference table with rear-lacquered glass or porcelain stoneware worktop mesa de reuniones con sobre en cristal retrolacado ou en gres porcelánico table réunion avec plateau en verre rétro-laqué ou en grès finition marbre Besprechungstisch aus Glas, auf der Rückseite lackiert, oder Arbeitsplatten in Porzellan Steingut mesa de reunião com plano em vidro retrolacado ou em grés porcelânico</p>	 T	100 39 3/8"	100 39 3/8"	74,5 29 3/8"	901.TV.77.10	1.575	1.638	2.902	64,00 141,12	0,116 4,09	4 4
 <p>tavolo riunioni con piano in vetro retrolaccato o gres porcellanato conference table with rear-lacquered glass or porcelain stoneware worktop mesa de reuniones con sobre en cristal retrolacado ou en gres porcelánico table réunion avec plateau en verre rétro-laqué ou en grès finition marbre Besprechungstisch aus Glas, auf der Rückseite lackiert, oder Arbeitsplatten in Porzellan Steingut mesa de reunião com plano em vidro retrolacado ou em grés porcelânico</p>	T	240 94 1/2"	120 47 1/4"	74,5 29 3/8"	901.TV.36.24	3.328	3.951	7.376	167,60 369,55	0,249 8,79	10 10

DV913 VIGO
DV911 NOTO
DV909 TOKIO
DV905 RYM
DV903 TAY
DV901 VERTIGO

sottomano desk pad	N
-----------------------	---

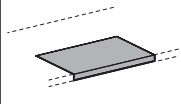
ACCESSORI ACCESSORIES	L. W.	P. D.	H. H.	CODICE CODE	PREZZO PRICE	Kg. lb	m ³ ft ³	n. no.
 <p>sottomano in cuoio nero per tavoli black leather desk pad for tables baden en cuero negro para mesas sous-main en cuir noir pour tables Schreibmappe aus Leder für Schreibtische, Schwarz apoio de mão em couro preto para mesas</p>	90 35 1/2"	60 23 5/8"	2 7/8"	300.AS.01.09	243	5,00 11,02	0,038 1,34	1 1

V01 piani worktops	M1	RC	NM	RS	RM	RT	L	WL			
	M2	NO					C	CBI	CNE	CTM	
								V02 gambe legs	W	H	A

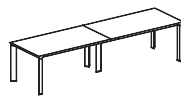
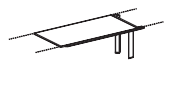
TAVOLI RIUNIONE CONFERENCE TABLES	L. W.	P. D.	H. H.	CODICE CODE	V01 / V02				Kg. lb	m ³ ft ³	n. no.
					M1	M2	L	C			
 <p>tavolo riunioni con gamba centrale rientrata conference table with returned central leg mesa de reuniones con pata central reentrada table de réunion avec pied central retourné Besprechungstisch mit mittlerem zurückspringendem Bein mesa reunião com perna central retornada</p>	320 126"	80 31 1/2"	75 29 5/8"	901.TR.55.32	1.804	1.908	2.092	3.588	73,80 162,72	0,211 7,45	9 9
	360 141 3/4"	90 35 1/2"	75 29 5/8"	901.TR.55.36	1.863	2.003	2.247	3.915	82,70 182,35	0,322 11,37	9 9
	400 157 1/2"	90 35 1/2"	75 29 5/8"	901.TR.55.40	1.891	2.021	2.319	4.203	95,90 211,45	0,338 11,94	9 9
 <p>elemento tavolo riunioni centrale con gamba rientrata central element conference table with returned central leg elemento mesa de reuniones central con pata central reentrada élément central table de réunion avec pied central retourné Zentralbestandteil Besprechungstisch mit zurückspringendem Bein elemento para mesa de reunião central com perna central retornada</p>	160 63"	80 31 1/2"	75 29 5/8"	901.TR.55.16	796	848	940	1.688	34,40 75,85	0,086 3,03	5 5
	180 70 7/8"	90 35 1/2"	75 29 5/8"	901.TR.55.18	817	887	1.009	1.843	38,50 84,89	0,174 6,14	5 5
	200 78 3/4"	90 35 1/2"	75 29 5/8"	901.TR.55.20	831	896	1.045	1.987	45,10 99,44	0,182 6,43	5 5

DV901 Vertigo

V01 piani
worktops

M1	RC	NM	RS	RM	RT
M2	NO				

L	WL
---	----

C	CBI	CNE	CTM
---	-----	-----	-----

V02 gambe legs	W	H	A
-------------------	---	---	---

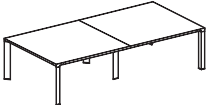
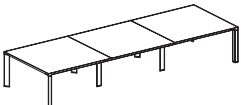
TAVOLI RIUNIONE CONFERENCE TABLES	L. W.	P. D.	H. H.	CODICE CODE	V01 / V02				Kg. lb	m ³ ft ³	n. no.
					M1	M2	L	C			
 <p>tavolo riunioni cm 160x160 conference table cm 160x160 mesa de reuniones de 160x160 cm table de réunion 160x160 cm Besprechungstisch 160x160 cm mesa de reunião cm 160x160</p>	160 63"	160 63"	75 29 5/8"	901.TR.43.16	1.179	1.450	1.486	2.620	60,30 132,96	0,173 6,11	4 4
 <p>elemento tavolo riunioni centrale cm 160x160 con gamba rientrata central element conference table cm 160x160 with returned central leg elemento mesa de reuniones central de 160x160 cm con pata reentrada élément central table de réunion 160x160 cm avec et pied central retourné Zentralbestandteil Besprechungstisch 160x160 cm mit zurückspringendem Bein elemento para mesa de reunião central cm 160x160 com perna central retornada</p>	160 63"	160 63"	75 29 5/8"	901.TR.32.16	937	1.208	1.244	2.378	54,50 120,17	0,139 4,91	5 5
 <p>tavolo riunioni cm 320x160 con gamba centrale rientrata conference table cm 320x160 with returned central leg mesa de reuniones de 320x160 cm con pata central reentrada table de réunion 320x160 cm avec pied central retourné Besprechungstisch 320x160 cm mit mittlerem zurückspringendem Bein mesa reunião cm 320x160 com perna central retornada</p>	320 126"	160 63"	75 29 5/8"	901.TR.32.32	2.116	2.658	2.730	4.998	114,80 253,13	0,312 11,02	9 9
 <p>tavolo riunioni cm 480x160 con gambe centrali rientrate conference table cm 480x160 with returned central legs mesa de reuniones de 480x160 cm con patas central reentradas table de réunion 480x160 cm avec pieds central retourné Besprechungstisch 480x160 cm mit mittlerem zurückspringendem Bein mesa reunião cm 480x160 com pernas central retornada</p>	480 189"	160 63"	75 29 5/8"	901.TR.32.48	3.053	3.866	3.974	7.376	169,30 373,30	0,451 15,93	14 14

DV913
VIGO

DV911
NOTO

DV909
TOKIO

DV905
RYM

DV903
TAY

DV901
VERTIGO

DV901 Vertigo

V01 piani worktops

M1	RC	NM	RS	RM	RT
M2	NO				

L	WL
---	----

C	CBI	CNE	CTM
---	-----	-----	-----

V02 gambe legs	W	H	A
----------------	---	---	---

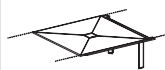
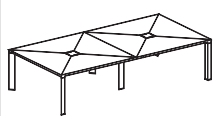
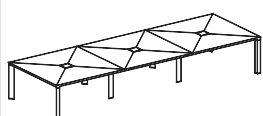
TAVOLI RIUNIONE CONFERENCE TABLES	L. W.	P. D.	H. H.	CODICE CODE	V01			Kg. lb	m ³ ft ³	n. no.
					M1	L	C			
 <p>tavolo riunioni cm 160x160 con piano composto conference table cm 160x160 with composed top mesa de reuniones de 160x160 cm con sobre compuesto table de réunion 160x160 cm avec plateau composé Besprechungstisch 160x160 cm mit zusammengesetzter Arbeitsplatte mesa de reunião cm 160x160 com plano componível</p>	160 63"	160 63"	75 29 5/8"	901.TR.51.16	2.077	2.561	4.053	73,90 162,94	0,320 11,30	9 9
 <p>elemento tavolo riunioni centrale con piano composto e gamba rientrata central element conference table with composed top and returned central leg elemento mesa de reuniones central cm con pata reentrada con sobre compuesto élément central table de réunion avec plateau composé et pied central retourné Zentralbestandteil Besprechungstisch mit zusammengesetzter Arbeitsplatte und mittleres zu elemento para mesa de reunião central com plano componível e perna central retornada</p>	160 63"	160 63"	75 29 5/8"	901.TR.52.16	1.835	2.319	3.811	68,10 150,16	0,286 10,10	10 10
 <p>tavolo riunioni con piani composti e gamba centrale rientrata conference table with composed tops and returned central leg mesa de reuniones cm con pata central reentrada con sobres compuestos table de réunion avec plateaux composé et pied central retourné Besprechungstisch mit zusammengesetzten Arbeitsplatten und mittleres zurückspringendes Be mesa reunião com planos componível e perna central retornada</p>	320 126"	160 63"	75 29 5/8"	901.TR.52.32	3.912	4.880	7.864	142,00 313,11	0,606 21,41	19 19
 <p>tavolo riunioni con piani composti e gambe centrali rientrate conference table with composed tops and returned central leg mesa de reuniones de con patas central reentradas con sobres compuestos table de réunion avec plateaux composé et pieds central retourné Besprechungstisch mit zusammengesetzten Arbeitsplatten und mittleres zurückspringendes Be mesa reunião com planos componível e perna central retornada</p>	480 189"	160 63"	75 29 5/8"	901.TR.52.48	5.747	7.199	11.675	210,10 463,27	0,892 31,51	29 29

DV901 Vertigo

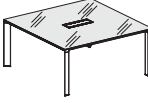
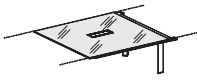
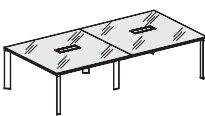
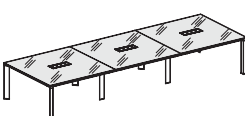
V01 piani worktops		VW	VAN	V02 gambe legs			W	H	A	V13 top access top access		W	H	N	
TAVOLI RIUNIONE CONFERENCE TABLES				L. W.	P. D.	H. H.	CODICE CODE		V01 / V02 / V13		Kg. lb	m ³ ft ³	n. no.		
									VW	VAN					
 <p>tavolo riunioni in vetro retrolaccato cm 160x160 conference table with rear-lacquered glass cm 160x160 mesa de reuniones en cristal retrolacado de 160x160 table de réunion en verre rétro-laqué 160x160cm Besprechungstisch aus Glas, auf der Rückseite lackiert 160x160 cm mesa de reunião em vidro retrolacado cm 160X160</p>				T	160 63"	160 63"	74,5 29 3/8"	901.TV.38.16	2.344	2.653	117.10 258,20	0,180 6,36	5 5	1 Top access incluso 1 Top access included 1 Top access incluido 1 Top access compris 1 Top Access Inbegriffen 1 Top access incluso Cod. 300.AC.20.04 L.44,7 cm - W. 17 1/2"	
 <p>elemento tavolo riunioni centrale in vetro retrolaccato con gamba rientrata central element conference table with rear-lacquered glass with returned central leg elemento mesa de reuniones central en cristal retrolacado con pata reentrada élément central table de réunion en verre rétro laqué avec pied central retourné Zentralbestandteil Besprechungstisch aus Glas, auf der Rückseite lackiert mit zurückspringendem Bein elemento para mesa de reunião central em vidro retro-lacado com perna central retornada</p>				T	160 63"	160 63"	74,5 29 3/8"	901.TV.47.16	2.316	2.625	115.80 255,33	0,148 5,22	7 7	1 Top access incluso 1 Top access included 1 Top access incluido 1 Top access compris 1 Top Access Inbegriffen 1 Top access incluso Cod. 300.AC.20.04 L.44,7 cm - W. 17 1/2"	
 <p>tavolo riunioni in vetro retrolaccato con gamba centrale rientrata conference table with rear-lacquered glass with returned central leg mesa de reuniones en cristal retrolacado con pata central reentrada table de réunion en verre rétro laqué avec et pied central retourné Zentralbestandteil Besprechungstisch aus Glas, auf der Rückseite lackiert mit zurückspringendem Bein mesa de reunião central em vidro retro-lacado com perna central retornada</p>				T	320 126"	160 63"	74,5 29 3/8"	901.TV.47.32	4.660	5.278	232,90 513,54	0,328 11,59	12 12	2 Top access inclusi 2 Top access included 2 Top access incluido 2 Top access compris 2 Top Access Inbegriffen 2 Top access incluso Cod. 300.AC.20.04 L.44,7 cm - W. 17 1/2"	
 <p>tavolo riunioni in vetro retrolaccato con gambe centrali rientrate conference table with rear-lacquered glass with returned central legs mesa de reuniones en cristal retrolacado con patas central reentrada table de réunion en verre rétro laqué avec et pieds central retourné Zentralbestandteil Besprechungstisch aus Glas, auf der Rückseite lackiert mit zurückspringendem Bein mesa de reunião central em vidro retro-lacado com pernas central retornada</p>				T	480 189"	160 63"	74,5 29 3/8"	901.TV.47.48	6.976	7.903	348,70 768,88	0,476 16,81	19 19	3 Top access inclusi 3 Top access included 3 Top access incluido 3 Top access compris 3 Top Access Inbegriffen 3 Top access incluso Cod. 300.AC.20.04 L.44,7 cm - W. 17 1/2"	

DV913 VIGO
DV911 NOTO
DV909 TOKIO
DV905 RYM
DV903 TAY
DV901 VERTIGO

POSIZIONAMENTO TAVOLI SCRIVANIA SU MOBILI DI SERVIZIO

Desk positioning on service unit / Posición mesas sobre muebles auxiliares / Positionnement du bureau sur meuble desserte / Schreibtischposition auf Beistellmöbel / Posicionamento da mesa escriturinha sobre o móvel de serviço

I tavoli possono essere montati sui mobili di servizio P. 66 - 92,5 cm D. 26" - 36 1/2" (destri o sinistri). Per ogni soluzione compositiva è disponibile a listino la dimensione del corrispondente modesty panel (vedi relativa quota indicata con MP) e del corrispondente canale passacavi (vedi relativa quota indicata con CP) / The desks can be fixed on the service units depth 66 - 92,5 cm / 26" - 36 1/2" (right or left hand). To order the modesty panel please check the dimensions marked with MP and the dimensions marked with CP for the relevant cables channel / Las mesas se pueden montar con muebles auxiliares P. 66 - 92,5 cm D. 26" - 36 1/2" (derechos o izquierdos). Por cada solución está disponible en tarifa la dimensión del correspondiente faldón (ver medida indicada con MP) y del correspondiente canal pasacables (ver correspondiente medida indicada con CP) / Les bureaux peuvent être fixés sur les dessertes P. 66 - 92,5 cm D. 26" - 36 1/2" (droit ou gauche). La dimension du voile de fond adéquat, pour chaque solution, est indiquée sur le tarif par les lettres MP, et pour la goulotte, par les lettres CP / Die Tische können in verschiedenen Positionen auf den Beistellmöbeln T. 66 - 92,5 cm D. 26" - 36 1/2" (rechts oder links). Für jede Lösung steht in der Preisliste die Abmessung der entsprechenden Knieblende zur Auswahl (siehe entsprechender Preis mit MP), und die Abmessung die entsprechenden Kabelkanal zur Auswahl (siehe entsprechender Preis mit CP) / As mesas podem ser montadas nos móveis de serviço P. 66 - 92,5 cm D. 26" - 36 1/2" (direitos ou esquerdos). Para cada solução componível encontra-se na lista de preços, a dimensão correspondente do modesty panel (vide relativa cota indicada por MP), e relativo canal passa-cabos (vide relativa cota indicada por CP).

Posizione di montaggio prevista per tavoli P. 90 cm - D. 35 1/2" L. 180 cm - W. 70 3/4" su mobili di servizio / Recommended assembly position of desks D. 90 cm - 35 1/2" W. 180 cm - 70 3/4" with service unit / Posición de montaje para mesas P. 90 cm - D. 35 1/2" L. 180 cm - W. 70 3/4" con muebles auxiliares / Position de montage prévue pour tables P. 90 cm - D. 35 1/2" L. 180 cm - W. 70 3/4" sur meuble desserte / Vorgesehene Montageposition für Tische T. 90 cm - D. 35 1/2" B. 180 cm - W. 70 3/4" mit Beistellmöbel / Posição de montagem prevista para mesa P. 90 cm - D. 35 1/2" L. 180 cm - W. 70 3/4" sobre o móvel de serviço

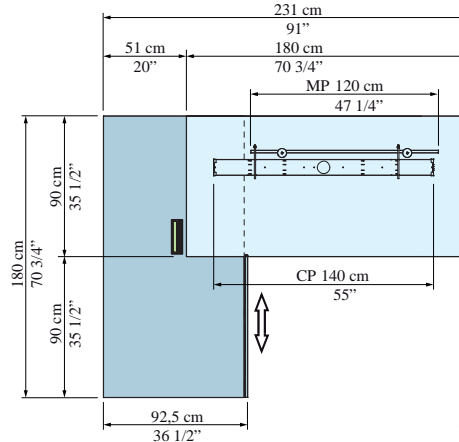
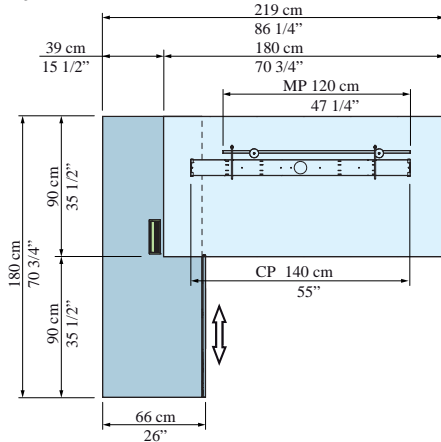

Cod. 901.TI.15.18

Posizione di montaggio prevista per tavoli P. 90 cm - D. 35 1/2" L. 200 cm - W. 78 3/4" su mobili di servizio / Recommended assembly position of desks D. 90 cm - 35 1/2" W. 200 cm - 78 3/4" with service unit / Posición de montaje para mesas P. 90 cm - D. 35 1/2" L. 200 cm - W. 78 3/4" con muebles auxiliares / Position de montage prévue pour tables P. 90 cm - D. 35 1/2" L. 200 cm - W. 78 3/4" sur meuble desserte / Vorgesehene Montageposition für Tische T. 90 cm - D. 35 1/2" B. 200 cm - W. 78 3/4" mit Beistellmöbel / Posição de montagem prevista para mesa P. 90 cm - D. 35 1/2" L. 200 cm - W. 78 3/4" sobre o móvel de serviço

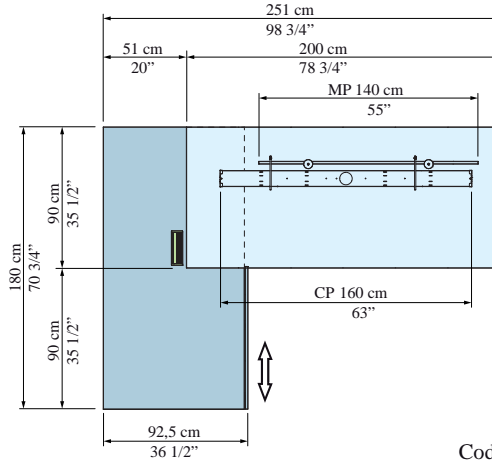
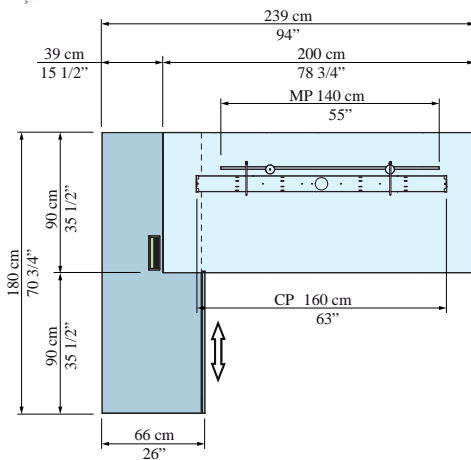

Cod. 901.TI.15.20

Posizione di montaggio prevista per tavoli riunione L. 160 cm - W. 63" su mobili di servizio / Recommended assembly position of meeting tables L. 160 cm - W. 63" with service unit / Posición de montaje para mesas reuniones L. 160 cm - W. 63" con muebles auxiliares / Position de montage prévue pour tables de réunion L. 160 cm - W. 63" sur meuble desserte / Vorgesehene Montageposition für Besprechungstische L. 160 cm - W. 63" mit Beistellmöbel / Posição de montagem prevista para mesa de reunião L. 160 cm - W. 63" sobre o móvel de serviço

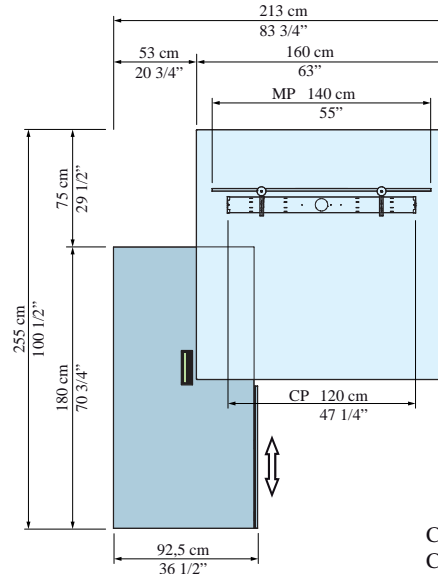
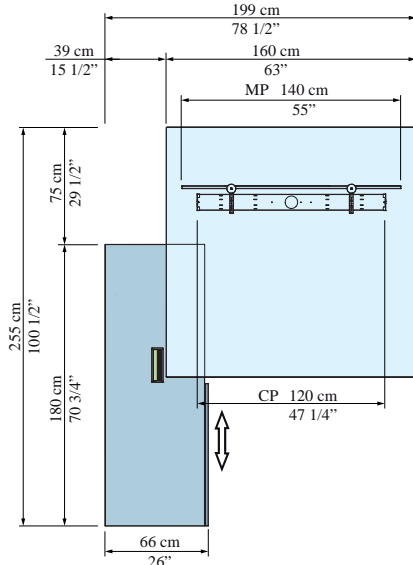

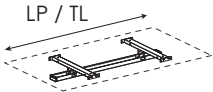
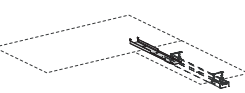

Cod. 901.TI.16.16 Dx/R
Cod. 901.TI.17.16 Sx/L

CANALIZZAZIONE WIRE MANAGEMENT	LP. TL.	CODICE CODE	PREZZO PRICE	Kg. lb	m ³ ft ³	n. no.
 <p>canale passacavi in lamiera piegata per tavoli</p> <p>cable channels made of sheet metal for desks</p> <p>canal pasacables en chapa doblada para mesas</p> <p>goulotte en acier plié pour bureaux</p> <p>Kabelkanal aus gebogenem Blech für Schreibtische</p> <p>canal passa-cabos em chapa de aço dobrada para mesas</p>	160 63"	901.AP.25.16	212	5,20 11,46	0,017 0,60	2 2
	180 70 7/8"	901.AP.25.18	231	5,70 12,56	0,021 0,74	2 2
	200 78 3/4"	901.AP.25.20	234	6,00 13,23	0,022 0,77	2 2
 <p>canale passacavi in lamiera piegata per tavoli dattilo collegabili 120 cm</p> <p>cable channels made of sheet metal for extension tables 120 cm</p> <p>canal pasacables en chapa doblada para alas acoplables 120 cm</p> <p>goulotte en acier plié pour dactylos suspendus 120 cm</p> <p>abelführungskanäle aus gebogenem Blech für anstellbare Schreibmaschinentische 120 cm</p> <p>canal passa-cabos em chapa de aço dobrada para mesas de teclado acopláveis 120 cm</p>	120 47 1/4"	901.AP.23.12	131	3,30 7,27	0,009 0,31	2 2
 <p>Prolunga da aggiungere ai canali passacavi utilizzati negli allunghi laterali (vedi disegno) per raccordo con il canale scrivania</p> <p>extension for the cable channels code used on the extension tables (see drawing) for the connection to the desk's cable channel</p> <p>Elemento de unión para integrar a los canales pasacables usados en los alargos laterales (ver dibujo), para la unión con el canal de la mesa</p> <p>Rallonge à ajouter aux goulottes utilisées avec les extensions latérales (voir dessin) pour unir à la goulotte du bureau</p> <p>Verlängerung für Kabelkanäle für seitliche Verlängerungen (siehe Zeichnung) für Anschluss am Kabelkanal des Schreibtischs</p> <p>Extensão para complementar os canais passa-cabos, utilizados nas extensões laterais (ver desenho) para interligações com canal escrivaninha</p>		300.AP.11.01	25	1,30 2,86	0,005 0,17	1 1

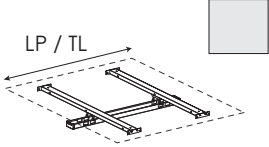
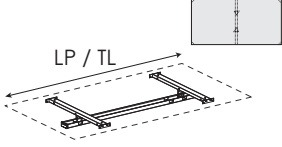
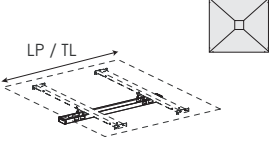
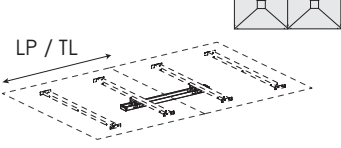
DV913 VIGO
DV911 NOTO
DV909 TOKIO
DV905 RYM
DV903 TAY
DV901 VERTIGO

CANALIZZAZIONE WIRE MANAGEMENT	LP. TL.	CODICE CODE	PREZZO PRICE	Kg. lb	m ³ ft ³	n. no.
 <p>canale passacavi in lamiera piegata per tavoli 160x160 cm</p> <p>cable channels made of sheet metal for desks 160x160 cm</p> <p>canal pasacables en chapa doblada para mesas de reuniones de 160x160 cm</p> <p>goulotte en acier plié pour bureaux 160x160 cm</p> <p>Kabelführungskanäle aus gebogenem Blech, für Schreibtische 160x160 cm</p> <p>canal passa-cabos em chapa de aço dobrada para mesas cm 160x160 cm</p>		901.AP.27.16	287	8,00 17,64	0,030 1,06	2 2
 <p>canale passacavi in lamiera piegata per tavoli riunione cm 240x120 cm</p> <p>cable channels made sheet metal for meeting tables cm 240x120 cm</p> <p>canal pasacables en chapa doblada para mesas de reuniones cm 240x120 cm</p> <p>goulotte en rond du acier plié pour table de réunion 240x120 cm</p> <p>Kabelführungskanäle aus gebogenem Blech, für Besprechungstisch 240x120 cm</p> <p>canal passa-cabos em chapa de aço dobrada para mesa de reunião cm 240x120 cm</p>		901.AP.44.24	274	8,30 18,30	0,027 0,95	2 2
 <p>canale passacavi in lamiera piegata per tavoli 160x160 cm con piani composti</p> <p>cable channels made of sheet metal for desks 160x160 cm with composed tops</p> <p>canal pasacables en chapa doblada para mesas 160x160 cm con sobres compuestos</p> <p>goulotte en acier plié pour bureaux 160x160 cm avec plateaux composé</p> <p>Kabelführungskanäle aus gebogenem Blech, für Schreibtische 160x160 cm mit zusammengesetzter Arbeitsplatte</p> <p>canal passa-cabos com chapa de aço dobrada para mesas 160x160 cm com planos componivel</p>	160 63"	901.AP.29.16	57	2,00 4,41	0,007 0,24	1 1
 <p>canale passacavi in lamiera piegata per tavoli riunioni con piani composti</p> <p>cable channels made of sheet metal for desks with composed tops</p> <p>canal pasacables en chapa doblada para mesas de reuniones con sobres compuestos</p> <p>goulotte en acier plié pour bureaux avec plateaux composé</p> <p>Kabelkanal aus gebogenem Blech, für Schreibtische mit zusammengesetzter Arbeitsplatte</p> <p>canal passa-cabos em chapa de aço dobrada para mesas com planos componivel</p>	160 63"	901.AP.52.16	57	2,00 4,41	0,007 0,24	1 1

CANALIZZAZIONE WIRE MANAGEMENT	LP. TL.	CODICE CODE	PREZZO PRICE	Kg. lb	m ³ ft ³	n. no.
 <p>canale passacavi in lamiera piegata per tavoli cm 180 con mobile di servizio</p> <p>sheet metal cable channel for desk cm 180 with service unit</p> <p>canal pasacables en chapa doblada para mesa cm 180 con mueble auxiliar</p> <p>goulotte passe câbles en acier plié pour bureaux 180 cm avec desserte</p> <p>Kabelführungskanäle aus gebogenem Blech, für Schreibtische 180 cm mit Beistellmöbel</p> <p>canal passa-cabos chapa de aço dobrada para mesas 180 cm com móvel de serviço</p>	180 70 7/8"	901.AP.42.18	205	6,40 14,11	0,024 0,84	3 3
 <p>canale passacavi in lamiera piegata per tavoli cm 200 con mobile di servizio</p> <p>sheet metal cable channel for desk cm 200 with service unit</p> <p>canal pasacables en chapa doblada para mesa cm 200 con mueble auxiliar</p> <p>goulotte passe câbles en acier plié pour bureaux 200 cm avec desserte</p> <p>Kabelführungskanäle aus gebogenem Blech, für Schreibtische 200 cm mit Beistellmöbel</p> <p>canal passa-cabos chapa de aço dobrada para mesas 200 cm com móvel de serviço</p>	200 78 3/4"	901.AP.42.20	215	7,00 15,43	0,026 0,91	3 3

DV913 VIGO
DV911 NOTO
DV909 TOKIO
DV905 RYM
DV903 TAY
DV901 VERTIGO

DV901 Vertigo

V09 modesty panel
modesty panel

M1	WN	HH	RC	NM	RS	RM	RT
M2	NO				L	WL	

C	CBI	CNE	CTM
---	-----	-----	-----

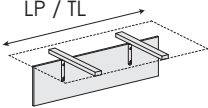
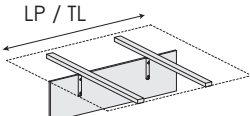
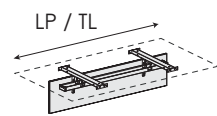
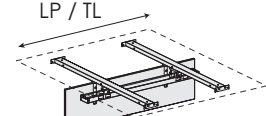
MODESTY PANELS MODESTY PANELS	LP. TL.	L. W.	P. D.	H. H.	CODICE CODE	V09				Kg. lb	m³ ft³	n. no.
						M1	M2	L	C			
 <p>modesty panel per tavolo modesty panel for desk panel de protección para mesa voile de fond pour bureau Modesty Paneel für Tisch modesty panel para mesa escritivanha</p>	160 63"	140 55 1/8"	1,8 3/4"	38 15"	901.MP.01.16	309	339	381	722	14,30 31,53	0,033 1,16	4 4
	180 70 3/4"	160 63"	1,8 3/4"	38 15"	901.MP.01.18	333	361	407	828	15,60 34,39	0,038 1,34	4 4
	200 78 3/4"	180 70 7/8"	1,8 3/4"	38 15"	901.MP.01.20	338	370	421	957	16,60 36,60	0,041 1,44	4 4
 <p>modesty panel per tavolo cm 160x160 modesty panel for desk cm 160x160 voile de fond pour bureau de 160x160 cm panel de protección para mesa de 160x160 cm Modesty Paneel für Tisch 160x160 cm modesty panel para mesa cm 160x160</p>	160 63"	140 55 1/8"	1,8 3/4"	38 15"	901.MP.11.16	384	414	456	797	17,10 37,70	0,046 1,62	4 4
	160 63"	140 55 1/8"	1,8 3/4"	38 15"	901.MP.16.16	366	396	438	779	16,30 35,94	0,040 1,41	5 5
	180 70 3/4"	160 63"	1,8 3/4"	38 15"	901.MP.16.18	394	422	468	889	17,80 39,24	0,047 1,66	5 5
 <p>modesty panel + canale passacavi per tavoli modesty panel + cable channels for desks panel de protección + canal pasacables para mesas voile de fond + goulotte pour bureaux Modesty Paneel + Kabelkanal für Schreibtische modesty panel + canal passa-cabos para mesas</p>	200 78 3/4"	180 70 7/8"	1,8 3/4"	38 15"	901.MP.16.20	402	434	485	1.021	19,10 42,11	0,051 1,80	5 5
	160 63"	140 55 1/8"	1,8 3/4"	38 15"	901.MP.32.16	441	471	513	854	19,10 42,11	0,053 1,87	5 5
	160 63"	140 55 1/8"	1,8 3/4"	38 15"	901.MP.32.16	441	471	513	854	19,10 42,11	0,053 1,87	5 5
 <p>modesty panel + canale passacavi per tavoli cm 160x160 modesty panel + cable channels for desks cm 160x160 panel de protección + canal pasacables para mesas de 160x160 cm voile de fond + goulotte pour bureaux de 160x160 cm Modesty Paneel + Kabelkanal für Schreibtische 160x160 cm modesty panel + canal passa-cabos para mesas cm 160x160</p>	160 63"	140 55 1/8"	1,8 3/4"	38 15"	901.MP.32.16	441	471	513	854	19,10 42,11	0,053 1,87	5 5

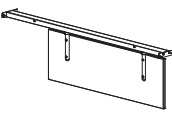
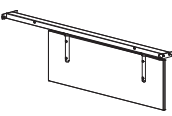

DV901 Vertigo

V09 modesty panel modesty panel	M1	WN	HH	RC	NM	RS	RM	RT	C	CBI	CNE	CTM
	M2	NO				L	WL					

MODESTY PANEL PER TAVOLI CON MOBILE DI SERVIZIO MODESTY PANELS FOR DESKS WITH SERVICE UNITS	L. W.	P. D.	H. H.	CODICE CODE	V09				Kg. lb	m ³ ft ³	n. no.
					M1	M2	L	C			
 <p>modesty panel cm. 120 per tavoli L. 180 cm modesty panel cm 120 for desks l.180 cm faldón cm 120 para mesas 180 cm voile de fond 120 cm pour bureaux L. 180 cm Modesty Paneel cm 120 für Tisch 180 cm modesty panel cm 120 para mesas L.180 cm</p>	120 47 1/4"	1,8 3/4"	38 15"	901.MP.08.12	260	287	333	686	13,60 29,98	0,035 1,23	4 4
 <p>modesty panel cm. 140 per tavoli L. 200 cm modesty panel cm 140 for desks l. 200 cm faldón cm 140 para mesas 200 cm voile de fond 140 cm pour bureaux L. 200 cm Modesty Paneel cm 140 für Tisch 200 cm modesty panel cm 140 para mesas L.200 cm</p>	140 55 1/8"	1,8 3/4"	38 15"	901.MP.09.14	282	312	354	695	14,90 32,85	0,038 1,34	4 4

Per ordinare il modesty panel vedi relativa nota tecnica

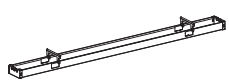
To order the modesty panel, please check technical notes
Para pedir el faldón ver relativa notas técnicas
Pour commander le voile de fond, voir note technique
Zu bestellen die Knieblende siehe entsprechende technischen Hinweis
Para encomendar o modesty panel, ver a nota técnica relevante

CANALIZZAZIONE WIRE MANAGEMENT	L. W.	CODICE CODE	PREZZO PRICE	Kg. lb	m ³ ft ³	n. no.
 <p>canale passacavi in lamiera piegata per modesty panel art. 901.MP.08.12 sheet metal cable channel for modesty panel art. 901.MP.08.12 canal pasacables en chapa doblada para modesty panel art. 901.MP.08.12 goulotte passe câbles en acier plié pour modesty panel art. 901.MP.08.12 Kabelkanal aus gebogenem Blech, für modesty panel Art. 901.MP.08.12 canal passa-cabos em chapa de aço dobrada para modesty panel art. 901.MP.08.12</p>	140 55"	901.AP.41.18	84	2,90 6,39	0,010 0,35	2 2
 <p>canale passacavi in lamiera piegata per modesty panel art. 901.MP.09.14 sheet metal cable channel for modesty panel art. 901.MP.09.14 canal pasacables en chapa doblada para modesty panel art. 901.MP.09.14 goulotte passe câbles en acier plié pour modesty panel art. 901.MP.09.14 Kabelkanal aus gebogenem Blech, für modesty panel Art. 901.MP.01.09.14 canal passa-cabos em chapa de aço dobrada para modesty panel art. 901.MP.09._</p>	180 70 3/4"	901.AP.41.20	87	3,20 7,05	0,011 0,38	2 2

