

# Tay

DV903



**LINEA DIREZIONALE**  
EXECUTIVE LINE  
SERIE EJECUTIVA  
LIGNES DE DIRECTION  
DIREKTIONSEINRICHTUNGSPROGRAMME  
LINHA DIRECÇÃO

DV903  
TAY

DV905  
RYM

DV909  
TOKIO

DV911  
NOTO

DV913  
VIGO

 **con serratura**  
with lock  
con cerradura  
avec serrure  
mit Schloss  
com fechadura

---

 **articolo non in pronta consegna. Per la disponibilità contattare l'ufficio commerciale**  
item not in prompt delivery. Please contact the commercial department for cheking availability  
producto no disponible en stock. Para la disponibilidad contactar con el departamento comercial  
article non disponible en stock. Merci de contacter le service commercial pour vérifier la disponibilité  
Dieses Produkt ist nicht sofort lieferbar. Setzen Sie sich mit unserem Handelsbüro in Verbindung für die Warenverfügbarkeit  
produtos não pronta entrega. Acerca da disponibilidade, contactar o sector comercial

---

**T** **vetro temperato**  
tempered glass  
cristal templado  
verre trempé  
Gehärtetes glas  
vidro temperado

---

 **fino ad esaurimento**  
until exhaustion  
sujeto a la disponibilidad  
soumises à disponibilité  
bis Erschöpfung  
até à exaustão

---

- V01 **Piani di lavoro in vetro temperato retrolaccato sp. 10 mm**  
 Rear-lacquered gloss tempered tops 10 mm thick  
 Sobre de trabajo en cristal retrolacado y templado 10 mm de grosor  
 Plans de travail en verre retro-lacqué trempé ep. 10 mm  
 Rückseite lackiertem ÄtzglasCristal aus Sicherheitsglas St. 10 mm  
 Plano de trabalho em vidro temperado espessura de 10 mm

VW

Bianco

White  
 Blanco  
 Blanc  
 Weiss  
 Branco

- V01 **Piani di lavoro in vetro temperato retrolaccato acidato sp. 10 mm**  
 Worktops rear-lacquered acetated tempered tops 10 mm thick  
 Sobre de trabajo en cristal retrolacado y ácido templado 10 mm de grosor  
 Plans de travail en verre retro-lacqué acide trempé ep. 10 mm  
 Tischplatte auslackiertem Ätzglas Crista aus Sicherheitsglas St. 10 mm  
 Plano de trabalho em vidro fosco temperado espessura de 10 mm

VAN

Nero

Black  
 Negro  
 Noir  
 Schwarz  
 Preto

- V01 **Piani di lavoro in vetro fumè temperato sp. 12 mm**  
 Worktops in tempered smoked grey glass 12 mm thick  
 Sobre de trabajo en cristal ahumado templado 12 mm de grosor  
 Plans de travail en verre fumé ep. 12 mm  
 Tischplatten aus gehärtetem Rauchglas St. 12 mm  
 Planos de trabalho em vidro fumé temperado, esp. 12 mm

VF

Vetro fumè

Smoked grey  
 Cristal ahumado  
 Fumé tremé  
 Gehärtetem Rauchglas  
 Fumé temperado

- V01 **Piano scrivania in vetro temprato trasparente sp. 8 mm, accoppiato con piano in gres porcellanato sp. 6 mm**  
 Desktop in 8 mm thick transparent tempered glass, matched with a 6 mm thick porcelain stoneware top  
 Encimera de cristal templado transparente de 8 mm de grosor, unida a una tapa de gres porcelánico de 6 mm de grosor  
 Plan de travail en verre trempé transparent de 8 mm d'ép., assorti d'un plateau en grès porcelaine de 6 mm d'ép.  
 Arbeitsplatte aus 8 mm dickem, transparentem, gehärtetem Glas in Kombination mit einer 6 mm dicken Platte aus Feinsteinzeug  
 Tampo de trabalho em vidro transparente temperado de 8 mm de espessura, combinado com uma placa de grés porcelânico de 6 mm de espessura

VGB

VGN

Bianco "Extra White"

Nero "Marquina"

White "Extra White"  
 Blanco "Extra White"  
 Blanc "Extra White"  
 Weiß "Extra White"  
 Branco "Extra White"

Black "Marquina"  
 Negro "Marquina"  
 Noir "Marquina"  
 Schwarz "Marquina"  
 Preto "Marquina"

**V02** **Strutture metalliche**  
 Metal structures  
 Estructuras metálicas  
 Structures métalliques  
 Metallstrukturen  
 Estruturas metálicas

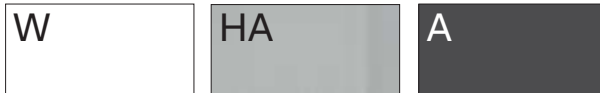

<b>W</b> Bianco White Blanco Blanc Weiß Branco	<b>HA</b> Alluminio "anodizzato" "anodized" aluminium aluminio "anodizado" aluminium "anodisé" "eloxiert" Aluminium aluminio "anodizado"	<b>A</b> Antracite Anthracite Antracita Anthracite Anthraxit Antracite
--	--	--

**V02** **Struttura metallica (gambone in metallo con base)**  
 Metallic structure (metal column base)  
 Estructura metalica (pata cilíndrica de metal)  
 Structure métallique (pied-colonne en métal avec base)  
 Metall struktur (Metallsäule mit Säulenfuß)  
 Estrutura metálica (pedestal em metal cor com base)

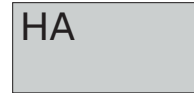

**HA**  
 Alluminio "anodizzato"  
 "anodized" aluminium  
 aluminio "anodizado"  
 aluminium "anodisé"  
 "eloxiert" Aluminium  
 alumínio "anodizado"



gambone alluminio / basamento inox  
 aluminium column / stainless steel base

**V13** **Top access Alluminio**  
 Top access Aluminium  
 Top access Aluminio  
 Top access Aluminium  
 Top Access Aluminium  
 Top access Aluminio



<b>W</b> Bianco White Blanco Blanc Weiss Branco	<b>H</b> Alluminio Aluminium Aluminio Aluminium Aluminium Aluminio	<b>N</b> Nero anodizzato Anodized black Negro anodizado Noir anodisé eloxiert Schwarz Preto anodizado
---	--	---

**Top access mobili di servizio (solo in colore alluminio)**  
 Top access Aluminium (only in aluminum colour)  
 Top access Aluminio (solo en color aluminio)  
 Top access Aluminium (uniquement en couleur aluminium)  
 Top Access Aluminium (nur in Aluminium)  
 Top access Aluminio (somente na cor aluminio)



**H**  
 Alluminio  
 Aluminium  
 Aluminio  
 Aluminium  
 Aluminium  
 Aluminio

**V09** **Modesty panel**  
 Modesty panel  
 Faldón  
 Voile de fond  
 Knieblende  
 Modesty panel



<b>M1</b> Melaminico sp. 18 mm Melamine 18 mm thick Melamina 18 mm de grosor Melaminé ép. 18 Mm épaisseur Melamin st. 18 Mm Melaminico esp. 18 Mm	<b>WN</b> Bianco White Blanco Blanc Weiss Branco	<b>HH</b> Alluminio Aluminium Aluminio Aluminium Aluminium Aluminio	<b>RC</b> Rovere chiaro Light oak Roble claro Chêne clair Eiche hell Carvalho claro	<b>NM</b> Noce "Maroncelli" Walnut "Maroncelli" Nogal "Maroncelli" Noyer "Maroncelli" Nussbaum "Maroncelli" Nogueira "Maroncelli"
---	--	---	---	---

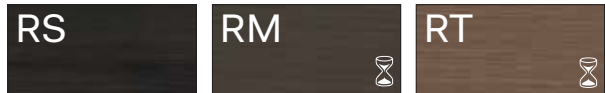

<b>RS</b> Rovere scuro Dark oak Roble oscuro Chêne foncé Eiche dunkel Carvalho escuro	<b>RM</b> Rovere moro Dark oak Roble oscuro Chêne foncé Eiche dunkel Carvalho escuro	<b>RT</b> Rovere tabacco Tobacco Oak Roble tabaco Chêne tabac Eiche tabak Carvalho tabaco
---	--	---



<b>M2</b> Melaminico sp. 18 mm Melamine 18 mm thick Melamina 18 mm de grosor Melaminé ép. 18 Mm épaisseur Melamin st. 18 Mm Melaminico esp. 18 Mm	<b>NO</b> Nero opaco Matt black Negro mate Noir matA Schwarz matt Preto opaco	<b>L</b> Laminato sp. 18 mm Laminate 18 mm thick Laminado 18 mm de grosor Laminé ép. 18 mm Laminat st. 18 mm Laminado de espessura de 18 mm	<b>WL</b> Bianco lucido Polished white Blanco brillo Blanc luisant Weiß hochglanz Branco brilhante
---	---	---	--

**V04 Mobile di servizio / cassettera per vano interno mobile di servizio e ripiano**  
 Service unit / pedestal for inside service unit and shelf  
 Mueble auxiliar / cajonera para hueco interior meuble auxiliar y balda  
 Desserte / caisson pour compartiment intérieur desserte et tablette  
 Beistellschrank / Schubladenelement für internes Beistellmöbel und Einlegeboden  
 Móvel de serviço / gaveteiro para compartimento interno móvel de serviço e prateleira

**M1**

Melaminico sp. 18/25 mm  
 Melamine 18/25 mm thick  
 Melamina 18/25 mm de grosor  
 Melaminé ép. 18/25 mm  
 Melamin st. 18/25 mm  
 Melaminico esp. 18/25 mm

**WN**

Bianco opaco  
 Matt white  
 Blanco opaco  
 Blanc mat  
 Mattweiß  
 Branco fosco

**RC**

Rovere chiaro  
 Light oak  
 Roble claro  
 Chêne clair  
 Eiche hell  
 Carvalho claro

**NM**

Noce "Maroncelli"  
 Walnut "Maroncelli"  
 Nogal "Maroncelli"  
 Noyer "Maroncelli"  
 Nussbaum "Maroncelli"  
 Nogueira "Maroncelli"

**RS**

Rovere scuro  
 Dark oak  
 Roble oscuro  
 Chêne foncé  
 Eiche dunkel  
 Carvalho escuro

**RM**

Rovere moro  
 Dark oak  
 Roble oscuro  
 Chêne foncé  
 Eiche dunkel  
 Carvalho escuro

**RT**

Rovere tabacco  
 Tobacco oak  
 Roble tabaco  
 Chêne tabac  
 Eiche tabak  
 Carvalho tabaco

**M2**

Melaminico sp. 18/25 mm  
 Melamine 18/25 mm thick  
 Melamina 18/25 mm de grosor  
 Melaminé ép. 18/25 mm  
 Melamin st. 18/25 mm  
 Melaminico esp. 18/25 mm

**NO**

Nero opaco  
 Matt black  
 Negro mate  
 Noir mat  
 Schwarz matt  
 Preto opaco

**L**

Laminato sp. 18/25 mm  
 Laminate 18/25 mm thick  
 Laminado 18/25 mm de grosor  
 Laminé ép. 18/25 mm  
 Laminat st. 18/25 mm  
 Laminado esp. 18/25 mm

**WL**

Bianco lucido  
 Polished white  
 Blanco brillo  
 Blanc luisant  
 Weiß hochglanz  
 Branco brilhante

**V81 Mobile di servizio - LATO SINISTRO (SX) o LATO DESTRO (DX)**  
 Service unit - LEFT HAND (SX) or RIGHT HAND (DX)  
 Mueble auxiliar - LADO IZQUIERDO (SX) o LADO DERECHO (DX)  
 Desserte - CÔTÉ GAUCHE (SX) ou CÔTÉ DROITE (DX)  
 Beistellschrank - LINKS (SX) oder RECHT (DX)  
 Móvel de serviço - LATERAL ISQUIERDA (SX) ou LATERAL DIREITO (DX)

**SX/L**

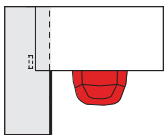

**DX/R**

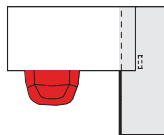

**V10 Cassetti interni disponibili in melaminico rivestiti in PVC (\*) o metallico (\*\*)**  
 Inside drawers available with melamine coated with PVC (\*) or metal (\*\*)  
 Interior de los cajones disponibles en melamina revestida en PVC (\*) o en metal (\*\*)  
 Intérieur tiroir disponibles en mélaminé revêtus de PVC (\*) ou métal (\*\*)  
 Interne Schublade verfügbar in folgenden Ausführungen aus Melamin PVC Spanplatte (\*) oder Metall (\*\*)  
 Gavetas internas disponíveis em melaminico revestidas em PVC (\*) ou metálico (\*\*)

**DFT \***

Grigio chiaro (standard)  
 Light grey (standard)  
 Gris claro (standard)  
 Gris clair (standard)  
 Hellgrau (standard)  
 Cinza claro (standard)

**AL01 \*\***

Alluminio  
 Aluminium  
 Aluminio  
 Aluminium  
 Aluminium  
 Aluminio

**V23**

maniglia  
 handle  
 tirador  
 poignée  
 rechteckiger  
 puxadores

**Q**

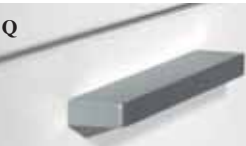

Int. 96 mm - L. 130 mm

**W**

**H**

**A**

**V**



Int. 256 mm - L. 275 mm

**W**

**H**

**A**

**T**

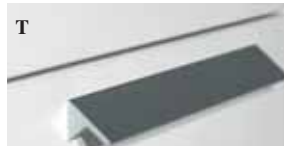

Int. 256 mm - L. 275 mm

**W**

**H**

**A**

DV913 VIGO  
 DV911 NOTO  
 DV909 TOKIO  
 DV905 RYM  
 DV903 TAY

## POSIZIONAMENTO TAVOLI SCRIVANIA SU MOBILI DI SERVIZIO

Desk positioning on service unit / Posición mesas sobre muebles auxiliares / Positionnement du bureau sur meuble desserte / Schreibtischposition auf Beistellmöbel / Posicionamento da mesa escrivantina sobre o móvel de serviço

I tavoli in vetro possono essere montati sui mobili di servizio P. 66 - 92,5 cm D. 26" - 36 1/2" (destri o sinistri) scegliendo tra diverse posizioni. Per ogni soluzione compositiva è disponibile a listino la dimensione del corrispondente modesty panel (vedi relativa quota indicata con MP) e del corrispondente canale passacavi (vedi relativa quota indicata con CP) / The glass desks can be fixed on the service units depth 66 - 92,5 cm D. 26" - 36 1/2" (right or left hand) with different positions. To order the modesty panel please check the dimensions marked with MP and the dimensions marked with CP for the relevant cables channel / Las mesas en cristal se pueden montar con muebles auxiliares P. 66 - 92,5 cm D. 26" - 36 1/2" (derechos o izquierdos) eligiendo entre diferentes posiciones. Por cada solución está disponible en tarifa la dimensión del correspondiente faldón (ver medida indicada con MP) y del correspondiente canal pasacables (ver correspondiente medida indicada con CP) / Les bureaux en verre peuvent être fixés sur les dessertes P. 66 - 92,5 cm D. 26" - 36 1/2" (droit ou gauche) en choisissant parmi positions diverses. La dimension du voile de fond adéquat, pour chaque solution, est indiquée sur le tarif par les lettres MP, et pour la goulotte, par les lettres CP / Die Tische Glas können in verschiedenen Positionen auf den Beistellmöbeln T. 66 - 92,5 cm D. 26" - 36 1/2" (rechts oder links) montiert werden. Für jede Lösung steht in der Preisliste die Abmessung der entsprechenden Knieblende zur Auswahl (siehe entsprechender Preis mit MP), und die Abmessung die entsprechenden Kabelkanal zur Auswahl (siehe entsprechender Preis mit CP) / As mesas em vidro podem ser montadas nos móveis de serviço P. 66 - 92,5 cm D. 26" - 36 1/2" (direitos ou esquerdos) a escolher entre diferentes posições. Para cada solução componível encontra-se na lista de preços, a dimensão correspondente do modesty panel (vide relativa cota indicada por MP), e relativo canal passa-cabos (vide relativa cota indicada por CP)

Le 3 posizioni di montaggio previste per tavoli L. 200 cm W. 78 3/4" - P. 100 cm D. 39 1/4" su mobile di servizio P. 66 cm - D. 26" / 3 positions foreseen for the tables W. 200 cm - 78 3/4" D. 100 cm - 39 1/4" mounted on service unit D. 66 cm - 26" / Las 3 posiciones de montaje previstas para mesas L. 200 cm W. 78 3/4" - P. 100 cm D. 39 1/4" con el mueble auxiliar P. 66 cm - D. 26" / Les 3 positions de montage prévues pour les tables L. 200 cm W. 78 3/4" - P. 100 cm D. 39 1/4" sur la desserte P. 66 cm - D. 26" / Die 3 möglichen Montagepositionen für Tische B. 200 cm W. 78 3/4" - T. 100 cm D. 39 1/4" auf Beistellmöbel T. 66 cm - D. 26" / As 3 posições de montagem previstas para mesas L. 200 cm W. 78 3/4" - P. 100 cm D. 39 1/4" com móvel de serviço P. 66 cm - D. 26"

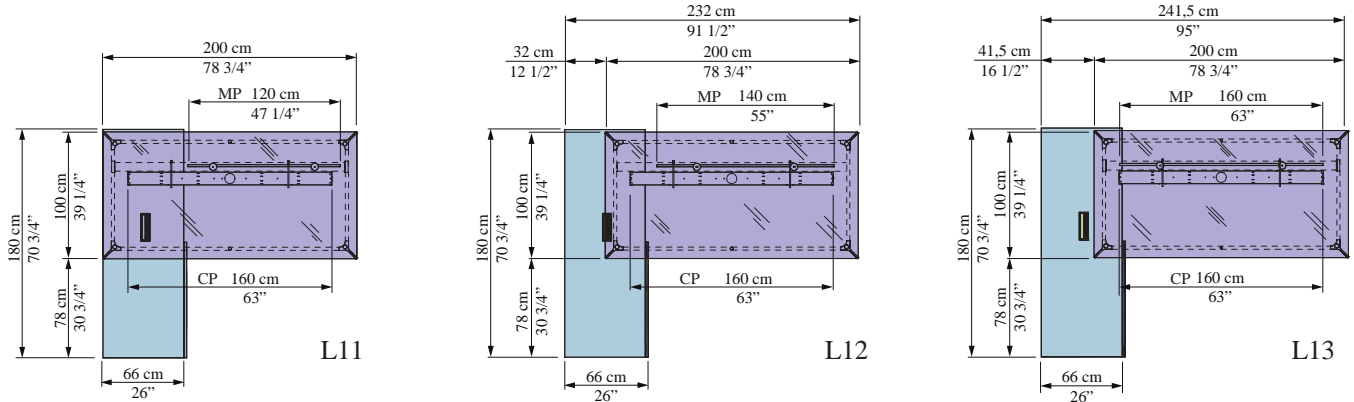

Le 3 posizioni di montaggio previste per tavoli L. 200 cm W. 78 3/4" - P. 100 cm D. 39 1/4" sul mobile di servizio P. 92,5 cm - D. 36 1/2" / 3 positions foreseen for the tables W. 200 cm - 78 3/4" D. 100 cm - 39 1/4" mounted on service unit D. 92,5 cm - 36 1/2" / Las 3 posiciones de montaje previstas para mesas L. 200 cm W. 78 3/4" - P. 100 cm D. 39 1/4" con el mueble auxiliar P. 92,5 cm - D. 36 1/2" / Les 3 positions de montage prévues pour les tables L. 200 cm W. 78 3/4" - P. 100 cm D. 39 1/4" sur la desserte P. 92,5 cm - D. 36 1/2" / Die 3 möglichen Montagepositionen für Tische B. 200 cm W. 78 3/4" - T. 100 cm D. 39 1/4" auf Beistellmöbel T. 92,5 cm - D. 36 1/2" / As 3 posições de montagem previstas para mesas L. 200 cm W. 78 3/4" - P. 100 cm D. 39 1/4" com móvel de serviço P. 92,5 cm - D. 36 1/2"

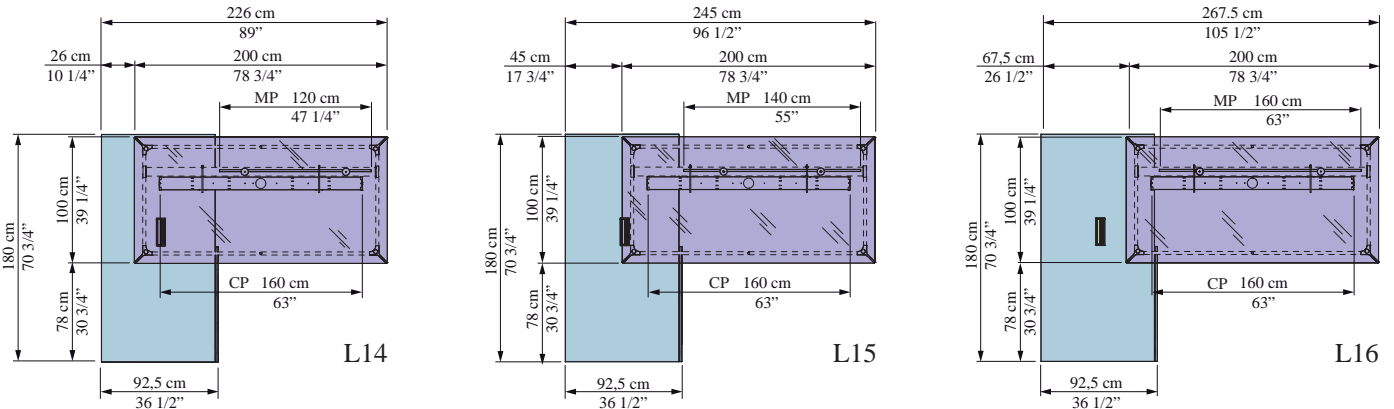

Le 2 posizioni di montaggio previste per tavolo scrivania/riunioni L. 160 cm - W. 63" con mobile di servizio P. 66 - 92,5 cm D. 26" - 36 1/2" (dx o sx) / 2 positions foreseen for the desk/meeting table W. 160 cm - 63" mounted on service unit D. 66/92,5 cm - 26"/36 1/2" (rh or lh) / Las 2 posiciones de montaje previstas para mesas/reuniones L. 160 cm W. 63" con el mueble auxiliar P. 66 - 92,5 cm D. 26" - 36 1/2" (dch o izq) / Les 2 positions de montage prévues pour les bureaux/tables de reunion L. 160 cm W. 63" sur les dessertes P. 66 - 92,5 cm D. 26" - 36 1/2" (dr ou gc) / Die 2 möglichen Montagepositionen für Schreibtische/Besprechungstisch B. 160 cm W. 63" auf Beistellmöbel T. 66 - 92,5 cm D. 26" - 36 1/2" (rechts order links) / As 2 posições de montagem previstas para mesa escrivantina/reuniões L. 160 cm W. 63" com móveis de serviço P. 66 - 92,5 cm D. 26" - 36 1/2" (dir. ou esq.)

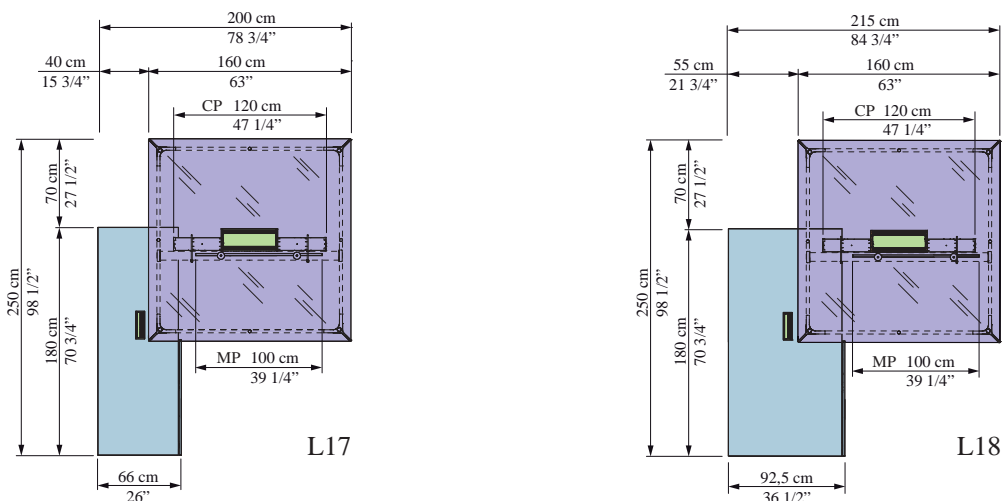

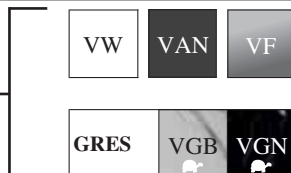

# DV903 Tay

V01 piani  
worktops

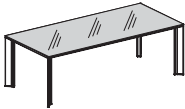

V02	gambe legs	W	HA	A
-----	---------------	---	----	---

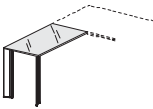
TAVOLI SCRIVANIA IN VETRO O GRES GLASS OR STONEWARE DESKS	L. W.	P. D.	H. H.	CODICE CODE	V01 / V02				Kg. lb	m <sup>3</sup> ft <sup>3</sup>	n. no.	
					VW	VAN	VF	GRES				
 <p><b>tavolo scrivania in vetro o gres porcellanato</b></p> <p>desk with glass or stoneware top</p> <p>mesa despacho en cristal o gres porcelánico</p> <p>table de bureau en verre ou grès finition marbre</p> <p>Schreibtisch aus Glas oder Porzellan Steingut</p> <p>mesa escrivaninha em vidro o grés porcelánico</p>	T	200 78 3/4"	100 39 3/8"	75 29 5/8"	903.TV.07.20	1.935	2.186	1.939	5.199	81,60 179,92	0,317 11,20	4 4
 <p><b>tavolo dattilo in vetro</b></p> <p>typing table with glass top</p> <p>ala para máquina de escribir en cristal</p> <p>table dactylo en verre</p> <p>Schreibmaschinentisch aus Glas</p> <p>mesa para teclado em vidro</p>	T	100 39 3/8"	60 23 5/8"	75 29 5/8"	903.TV.05.10	1.239	1.265	1.084	2.108	42,20 93,05	0,189 6,67	4 4
 <p><b>allungo in vetro</b></p> <p>extension table glass top</p> <p>ala en cristal</p> <p>retour verre pour bureau</p> <p>Anschluss aus Glas</p> <p>extensão esquerdo em vidro</p>	T	100 39 3/8"	60 23 5/8"	75 29 5/8"	903.TV.04.10	1.092	1.118	937	1.961	38,40 84,67	0,132 4,66	4 4

DV913 VIGO  
DV911 NOTO  
DV909 TOKIO  
DV905 RYM  
DV903 TAY



# DV903 Tay

V01 piani  
worktops

VW	VAN	VF
GRES	VGB	VGN

V02 gambe legs	W	HA	A
-------------------	---	----	---

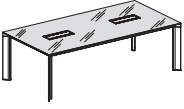

V13 top access top access	W	H	N
------------------------------	---	---	---

TAVOLI RIUNIONE IN VETRO O GRES GLASS OR STONEWARE MEETING TABLES	L. W.	P. D.	H. H.	CODICE CODE	V01 / V02 / V13				Kg. lb	m <sup>3</sup> ft <sup>3</sup>	n. no.
					VW	VAN	VF	GRES			
 <p><b>tavolo riunioni con piano in gres</b> T</p> <p>conference table with stoneware top table de réunion en gres porcelánico table de réunion en grès finition marbre Besprechungstisch mit Arbeitsplatten in Porzellan Steingut mesa de reunião em grés porcelánico</p>	140 55 1/8"	140 55 1/8"	75 29 5/8"	903.TV.38.14	-	-	-	4.347	25,90 57,10	0,144 5,08	4 4
 <p><b>tavolo riunioni in vetro</b> T</p> <p>meeting table with glass top mesa de reuniones en cristal table réunion en verre Besprechungstisch aus Glas mesa de reunião em vidro</p>	160 63"	160 63"	75 29 5/8"	903.TV.38.16	2.403	2.755	2.418	-	120,50 265,70	0,444 15,68	5 5
 <p><b>tavolo riunioni in vetro o gres porcellanato</b> T</p> <p>meeting table with glass or stoneware top mesa de reuniones en cristal o gres porcelánico table réunion en verre ou grès finition marbre Besprechungstisch aus Glas oder Porzellan Steingut mesa de reunião em vidro o grés porcelánico</p>	240 94 1/2"	120 47 1/4"	75 29 5/8"	903.TV.56.24	2.726	3.107	2.771	6.260	169,80 374,40	0,385 13,60	6 6



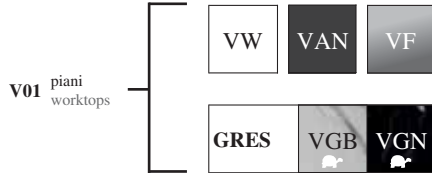

# DV903 Tay

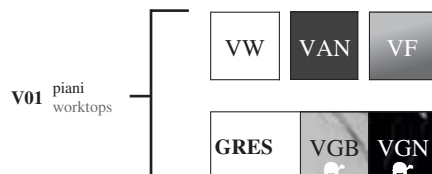

TAVOLI RIUNIONE CONFERENCE TABLES	L. W.	P. D.	H. H.	CODICE CODE	V01				Kg. lb	m <sup>3</sup> ft <sup>3</sup>	n. no.	
					VW	VAN	VF	GRES				
 <p><b>tavolo riunioni circolare in vetro o gres porcellanato su gambone in metallo con base finitura inox</b></p> <p>round meeting table with glass or stoneware top and with metal column, base inox finish</p> <p>mesa de reuniones redonda en cristal o en gres porcelánico con pata cilíndrica de metal y con base cuadrada acabado inox</p> <p>table de réunion ronde en verre ou en grès finition marbre, sur pied-colonne en métal avec base arrée finitoin inox</p> <p>runder Besprechungstisch aus Glas oder Porzellan Steingut, auf Metallsäule mit mit quadratischem Fuß Edelstahlfarbig</p> <p>mesa de reunião circular em vidro o grés porcelânico, sobre pedestal em metal cor alumínio com base quadrada, acabamento inox</p>	100 39 3/8"	100 39 3/8"	75 29 5/8"	903.TV.14.10	1.031	1.161	1.046	2.444	56,20 123,92	0,100 3,53	4 4	
					 <p>gambone alluminio / basamento inox aluminium column / stainless steel base</p>							



V02 gamboni columns	W	HA	A
---------------------	---	----	---

TAVOLI RIUNIONE CONFERENCE TABLES	L. W.	P. D.	H. H.	CODICE CODE	V01 / V02				Kg. lb	m <sup>3</sup> ft <sup>3</sup>	n. no.	
					VW	VAN	VF	GRES				
 <p><b>tavolo riunioni circolare in vetro o gres porcellanato su gambone in metallo con base</b></p> <p>round meeting table with glass or stoneware top and with metal column base</p> <p>mesa de reuniones redonda en cristal o en gres porcelánico con pata cilíndrica de metal</p> <p>table de réunion ronde en verre ou en grès finition marbre, sur pied-colonne en métal avec base</p> <p>runder Besprechungstisch aus Glas oder Porzellan Steingut, auf Metallsäule mit Säulenfuß</p> <p>mesa de reunião circular em vidro o grés porcelânico, sobre pedestal em metal cor alumínio com base</p>	100 39 3/8"	100 39 3/8"	75 29 5/8"	903.TV.15.10	890	1.020	905	2.303	62,90 138,69	0,107 3,78	4 4	
												

DV913 VIGO  
DV911 NOTO  
DV909 TOKIO  
DV905 RYM  
DV903 TAY

# DV903 Tay



<b>V02</b> gambe legs	W	HA	A
-----------------------	---	----	---

<b>V81</b> verso hand	Sx	Dx
-----------------------	----	----

TAVOLI CON MOBILI DI SERVIZIO DESK WITH SERVICE UNIT	V04	LP. TL.	L. W.	P. D.	H. H.	MSP. SUD.	CODICE CODE	V01				Kg. lb	m <sup>3</sup> ft <sup>3</sup>	n. no.	
								VW	VAN	VF	GRES				
<p><b>tavolo scrivania in vetro con mobile di servizio</b> desk with glass top with service unit mesa de cristal con mueble auxiliar bureau en verre avec desserte Schreibtisch aus Glas mit Beistellmöbel mesa tipo escrivaninha em vidro com móvel de serviço</p>	T	M1	200 78 3/4"	L11-L12 L13	180 70 7/8"	75 29 5/8"	66 26"	<b>903.TV.6M.20</b>	<b>3.306</b>	<b>3.557</b>	<b>3.310</b>	<b>6.570</b>	190,50 420,05	0,511 18,05	9 9
	T	M2	200 78 3/4"	L11-L12 L13	180 70 7/8"	75 29 5/8"	66 26"	<b>903.TV.6M.20</b>	<b>3.592</b>	<b>3.843</b>	<b>3.596</b>	<b>6.856</b>	190,50 420,05	0,511 18,05	9 9
	T	L	200 78 3/4"	L11-L12 L13	180 70 7/8"	75 29 5/8"	66 26"	<b>903.TV.6W.20</b>	<b>4.057</b>	<b>4.308</b>	<b>4.061</b>	<b>7.321</b>	190,50 420,05	0,511 18,05	9 9
	T	M1	200 78 3/4"	L11-L12 L13	180 70 7/8"	75 29 5/8"	92,5 36 1/2"	<b>903.TV.9M.20</b>	<b>3.494</b>	<b>3.745</b>	<b>3.498</b>	<b>6.758</b>	224,00 493,92	0,588 20,77	10 10
	T	M2	200 78 3/4"	L11-L12 L13	180 70 7/8"	75 29 5/8"	92,5 36 1/2"	<b>903.TV.9M.20</b>	<b>3.863</b>	<b>4.114</b>	<b>3.867</b>	<b>7.127</b>	224,00 493,92	0,588 20,77	10 10
	T	L	200 78 3/4"	L11-L12 L13	180 70 7/8"	75 29 5/8"	92,5 36 1/2"	<b>903.TV.9W.20</b>	<b>4.441</b>	<b>4.692</b>	<b>4.445</b>	<b>7.705</b>	224,00 493,92	0,588 20,77	10 10

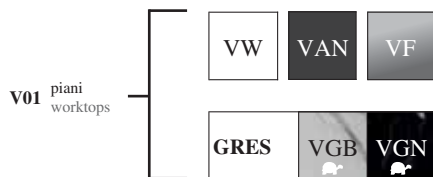

TAVOLI INTEGRABILI CON MOBILE DI SERVIZIO INTEGRABLE DESKS FOR SERVICE UNITS	L. W.	P. D.	H. H.	CODICE CODE	V01 / V02				Kg. lb	m <sup>3</sup> ft <sup>3</sup>	n. no.
					VW	VAN	VF	GRES			
<p><b>tavolo scrivania in vetro per integrazione con mobile di servizio</b> desk glass top, to be completed with the service unit mesa en cristal para integración con mueble auxiliar bureau en verre pour intégration aux dessertes Schreibtisch aus Glas, für Ergänzung mit Beistellmöbel mesa escrivaninha em vidro para integrar com móvel de serviço</p>	200 78 3/4"	100 39 3/8"	75 29 5/8"	<b>903.TV.09.20</b>	<b>1.838</b>	<b>2.089</b>	<b>1.842</b>	<b>5.102</b>	77,60 171,10	0,269 9,50	4 4

# DV903 Tay

<b>V01</b> piani worktops	VW	VAN	VF
------------------------------	----	-----	----

<b>V02</b> gambe legs	W	HA	A
--------------------------	---	----	---

<b>V13</b> top access top access	W	H	N
-------------------------------------	---	---	---

<b>V81</b> verso hand	Sx	Dx
--------------------------	----	----

**V04** mobile di servizio  
service unit

M1	WN	RC	NM	RS	RM	RT
M2	NO					
L	WL					

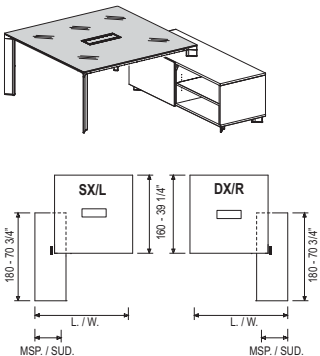
TAVOLI CON MOBILI DI SERVIZIO DESK WITH SERVICE UNIT	MSF. SUF.	LP. TL.	L. W.	P. D.	H. H.	MSP. SUD.	CODICE CODE	CATEGORIA PREZZO PRICE CATEGORY			Kg. lb	m <sup>3</sup> ft <sup>3</sup>	n. no.		
								VW	VAN	VF					
 <p><b>tavolo scrivania / riunioni in vetro con mobile di servizio</b> desk / meeting table in glass with the service unit mesa/reuniones en cristal con mueble auxiliar bureau/réunion en verre avec desserte Schreibtisch/ Besprechungstisch aus Glas mit Beistellmöbel mesa escrivaninha/de reunião em vidro com móveis de serviço</p>	T	M1	160 63"	L17- L18	250 98 1/2"	75 29 5/8"	66 26"	<b>903.TV.6M.17</b>	<b>3.832</b>	<b>4.184</b>	<b>3.847</b>	232,40 512,44	0,686 24,24	10 10	
	T	M2	160 63"	L17- L18	250 98 1/2"	75 29 5/8"	66 26"	<b>903.TV.6M.17</b>	<b>4.118</b>	<b>4.470</b>	<b>4.133</b>	232,40 512,44	0,686 24,24	10 10	
	T	L	160 63"	L17- L18	250 98 1/2"	75 29 5/8"	66 26"	<b>903.TV.6W.17</b>	<b>4.583</b>	<b>4.935</b>	<b>4.598</b>	232,40 512,44	0,686 24,24	10 10	
	T	M1	160 63"	L17- L18	250 98 1/2"	75 29 5/8"	92,5 36 1/2"	<b>903.TV.9M.17</b>	<b>4.020</b>	<b>4.372</b>	<b>4.035</b>	265,90 586,30	0,763 26,96	11 11	
	T	M2	160 63"	L17- L18	250 98 1/2"	75 29 5/8"	92,5 36 1/2"	<b>903.TV.9M.17</b>	<b>4.389</b>	<b>4.741</b>	<b>4.404</b>	265,90 586,30	0,763 26,96	11 11	
	T	L	160 63"	L17- L18	250 98 1/2"	75 29 5/8"	92,5 36 1/2"	<b>903.TV.9W.17</b>	<b>4.967</b>	<b>5.319</b>	<b>4.982</b>	265,90 586,30	0,763 26,96	11 11	
								<b>1 Top access incluso</b> 1 Top access included 1 Top access incluido 1 Top access compris 1 Top Access Inbegriffen 1 Top access incluso <b>Cod. 300.AC.20.04</b> L.44,7 cm - W. 17 1/2"							

DV913  
VIGO

DV911  
NOTO

DV909  
TOKIO

DV905  
RYM

DV903  
TAY

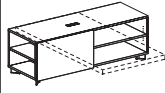
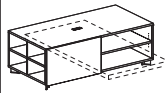

# DV903 Tay

V04 mobile di servizio service unit	M1	WN	RC	NM	RS	RM	RT	V02 gambe legs	W	HA	A
	M2	NO				L	WL	V81 verso hand	Sx	Dx	

MOBILI DI SERVIZIO SERVICE UNITS	MSF. SUF.	L. W.	P. D.	H. H.	CODICE CODE	V04 V02 V81	Kg. lb	m³ ft³	n. no.
 DX/R SX/L	M1	180 70 7/8"	66 26"	61 24 1/8"	903.MS.6M.18	V04 1.468	112,90 248,94	0,242 8,55	5 5
	M2	180 70 7/8"	66 26"	61 24 1/8"	903.MS.6M.18	V04 1.754	112,90 248,94	0,242 8,55	5 5
	L	180 70 7/8"	66 26"	61 24 1/8"	903.MS.6W.18	V04 2.219	112,90 248,94	0,242 8,55	5 5
<b>mobile di servizio cm 180x66</b> service unit cm 180x66 mueble auxiliar 180x66 cm desserte 180x66 cm Beistellmöbel 180x66 cm móvel de serviço cm 180x66									
 DX/R SX/L	M1	180 70 7/8"	92,5 36 1/2"	61 24 1/8"	903.MS.9M.18	V04 1.656	146,40 322,81	0,319 11,27	6 6
	M2	180 70 7/8"	92,5 36 1/2"	61 24 1/8"	903.MS.9M.18	V04 2.025	146,40 322,81	0,319 11,27	6 6
	L	180 70 7/8"	92,5 36 1/2"	61 24 1/8"	903.MS.9W.18	V04 2.603	146,40 322,81	0,319 11,27	6 6
<b>mobile di servizio cm 180x92,5</b> service unit cm 180x92,5 mueble auxiliar 180x92,5 cm desserte 180x92,5 cm Beistellmöbel 180x92,5 cm móvel de serviço cm 180x92,5									

V10 cassetti interni metal drawers	PVC	DFT
	MET	AL01

V04 cassettiere pedestals	M1	WN	RC	NM	RS	RM	RT
	M2	NO					
	L	WL					

V23 maniglia handle	Q		V		W
	T				H
					A

CASSETTIERE PER MOBILI DI SERVIZIO PEDESTALS FOR SERVICE UNITS	L. W.	P. D.	H. H.	CODICE CODE	V10-PVC			Kg. lb	m³ ft³	n. no.
					M1	M2	L			
 <b>cassettiera 3 cassetti per vano interno mobile di servizio + ripiano</b> 3 drawers pedestal for inside service unit + shelf cajonera 3 cajones para hueco interior mueble auxiliar + balda caisson 3 tiroirs pour compartiment intérieur desserte + tablette Schubladenelement mit 3 Schüben für internes Beistellmöbel + Einlegeboden gaveteiro 3 gavetas para compartimento interno móvel de serviço + prateleira	42 16 1/2"	55 21 3/4"	48 21 3/4"	550.CM.01.04	325	391	414	27,24 60,06	0,167 5,90	4 4
					V10-MET					
					374	429	452			

canale passacavi verticale vertical cable channel	HA
--	----

CANALIZZAZIONE WIRE MANAGEMENT	L. W.	P. D.	H. H.	CODICE CODE	PREZZO PRICE	Kg. lb	m <sup>3</sup> ft <sup>3</sup>	n. no.
 <p><b>canale passacavi verticale in alluminio per gamba tavoli</b></p> <p>vertical cable channel for desk's leg</p> <p>canal pasacables vertical en aluminio para pata mesa</p> <p>goulotte passe-cables verticale en aluminium pour piètement table</p> <p>Senkrechter Kabelkanal aus Aluminium für Tischbein</p> <p>guia de cabos vertical em alumínio para perna de mesa</p>			63 24 7/8"	<b>903.AP.08.00</b>	<b>15</b>	0,50 1,10	0,003 0,10	1 1
				<p><b>solo alluminio anodizzato</b> only "anodized" aluminium sólo aluminio "anodizado" uniquement aluminium "anodisé" nur "eloxiert" Aluminium só alumínio "anodizado"</p>				

DV913  
VIGO

DV911  
NOTO



DV909  
TOKIO

DV905  
RYM

DV903  
TAY

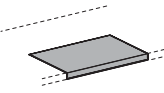
sottomano desk pad	N
-----------------------	---

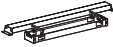
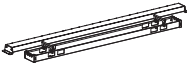
ACCESSORI ACCESSORIES	L. W.	P. D.	H. H.	CODICE CODE	PREZZO PRICE	Kg. lb	m <sup>3</sup> ft <sup>3</sup>	n. no.
 <p><b>sottomano in cuoio nero per tavoli</b></p> <p>black leather desk pad for tables</p> <p>baden en cuero negro para mesas</p> <p>sous-main en cuir noir pour tables</p> <p>Schreibmappe aus Leder für Schreibtische, Schwarz</p> <p>apoio de mão em couro preto para mesas</p>	90 35 1/2"	60 23 5/8"	2 7/8"	<b>300.AS.01.09</b>	<b>243</b>	5,00 11,02	0,038 1,34	1 1

CANALIZZAZIONE PER TAVOLI IN VETRO WIRE MANAGEMENT FOR GLASS TABLES	L. W.	CODICE CODE	PREZZO PRICE	Kg. lb	m <sup>3</sup> ft <sup>3</sup>	n. no.
 <p><b>canale passacavi in lamiera piegata per dattilo collegabili cm 100</b></p> <p>cable channels made of sheet metal for high extension tables cm 100</p> <p>canal pasacables en chapa doblada para alas acoplables cm 100</p> <p>goulotte en acier plié pour dactylos suspendus cm 100</p> <p>Kabelkanal aus gebogenem Blech, für anstellbare Schreibmaschinentische cm 100</p> <p>canal passa-cabos em chapa de aço dobrada para mesas de teclado acopláveis cm 100</p>	100 39 3/8"	<b>903.AP.25.10</b>	<b>168</b>	4,10 9,04	0,009 0,31	3 3
 <p><b>canale passacavi in lamiera piegata per tavoli cm 160x160</b></p> <p>cable channels made of sheet metal for desks cm 160x160</p> <p>canal pasacables en chapa doblada para mesas cm 160x160</p> <p>goulotte en acier plié pour bureaux 160x160 cm</p> <p>Kabelkanal aus gebogenem Blech, für Schreibtische 160x160 cm</p> <p>canal passa-cabos em chapa de aço dobrada para mesas 160x160 cm</p>	160 63"	<b>903.AP.25.16</b>	<b>204</b>	6,80 14,99	0,017 0,60	3 3
 <p><b>canale passacavi in lamiera piegata per tavoli cm 200</b></p> <p>cable channels made of sheet metal for desks cm 200</p> <p>canal pasacables en chapa doblada para mesas cm 200</p> <p>goulotte en acier plié pour bureaux 200 cm</p> <p>Kabelkanal aus gebogenem Blech, für Schreibtische 200 cm</p> <p>canal passa-cabos em chapa de aço dobrada para mesas 200 cm</p>	200 78 3/4"	<b>903.AP.25.20</b>	<b>225</b>	7,70 16,97	0,022 0,77	3 3
 <p><b>canale passacavi in lamiera piegata per tavoli cm 240x120</b></p> <p>cable channels made of sheet metal for desks cm 240x120</p> <p>canal pasacables en chapa doblada para mesas cm 240x120</p> <p>goulotte en acier plié pour bureaux 240x120 cm</p> <p>Kabelkanal aus gebogenem Blech, für Schreibtische 240x120 cm</p> <p>canal passa-cabos em chapa de aço dobrada para mesas 240x120 cm</p>	240 94 1/2"	<b>903.AP.25.24</b>	<b>242</b>	8,20 18,08	0,025 0,88	3 3

# DV903 Tay

V09 modesty panel modesty panel	M1	WN	HH	RC	NM	RS	RM	RT	L	WL
	M2	NO								

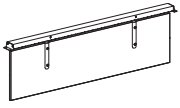
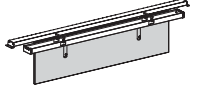
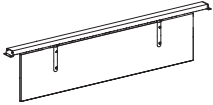
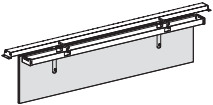
MODESTY PANELS PER TAVOLI VETRO MODESTY PANEL FOR GLASS TABLES	L. W.	P. D.	H. H.	CODICE CODE	V09			Kg. lb	m <sup>3</sup> ft <sup>3</sup>	n. no.
					M1	M2	L			
 <p><b>modesty panel L.140 cm per tavolo riunioni L. 160x160</b> modesty panel w.140 cm for meeting table 160x160 cm modesty panel L.140 cm para mesas L. 160x160 cm voile de fond L.140 cm pour bureaux L. 160x160 cm Knieblende B. 140 cm für Schreibtischen L.160x160 cm modesty panel L.140 cm para mesas L. 160x160 cm</p>	140 55 1/8"	1,8 3/4"	38 15"	<b>903.MP.05.16</b>	<b>278</b>	<b>308</b>	<b>350</b>	15,20 33,51	0,032 1,13	4 4
				<p><b>Per ordinare il modesty panel vedi relativa nota tecnica</b></p> <p>To order the modesty panel, please check technical notes Para pedir el faldón ver relativa notas técnicas Pour commander le voile de fond, voir note technique Zu bestellen die Knieblende siehe entsprechende technischen Hinweis Para encomendar o modesty panel, ver a nota técnica relevante</p>						
 <p><b>modesty panel L.140 cm + canale passacavi in lamiera piegata per tavoli cm 160x160</b> modesty panel w. 140 cm + cable channels made of sheet metal desks 160x160 cm panel de protección L.140 cm + canal pasacables en chapa doblada para mesas de 160x160 cm voile de fond L.140 cm + goulotte en acier plié pour bureaux de 160x160 cm Modesty Paneel B.140 cm + Kabelkanal aus gebogenem Blech, für Schreibtische 160x160 cm modesty panel L.140 cm + canal passa-cabos chapa de aço dobrada para mesa escritivaninha cm 160x160</p>	140 55 1/8"	1,8 3/4"	38 15"	<b>903.MP.17.14</b>	<b>379</b>	<b>409</b>	<b>451</b>	18,80 41,45	0,045 1,59	6 6
				<p><b>Per ordinare il modesty panel vedi relativa nota tecnica</b></p> <p>To order the modesty panel, please check technical notes Para pedir el faldón ver relativa notas técnicas Pour commander le voile de fond, voir note technique Zu bestellen die Knieblende siehe entsprechende technischen Hinweis Para encomendar o modesty panel, ver a nota técnica relevante</p>						
 <p><b>modesty panel L.180 cm per scrivanie L.200 cm</b> modesty panel w.180 cm for desks w.200 cm faldón para mesa de L.180 cm para mesas L.200 cm voile de fond L.180 cm pour bureaux L.200 cm Knieblende B. 180 cm für Schreibtischen L.200 cm modesty panel L.180 cm para mesas L. 200 cm</p>	180 70 7/8"	1,8 3/4"	38 15"	<b>903.MP.05.20</b>	<b>306</b>	<b>338</b>	<b>389</b>	17,60 38,80	0,040 1,41	4 4
				<p><b>Per ordinare il modesty panel vedi relativa nota tecnica</b></p> <p>To order the modesty panel, please check technical notes Para pedir el faldón ver relativa notas técnicas Pour commander le voile de fond, voir note technique Zu bestellen die Knieblende siehe entsprechende technischen Hinweis Para encomendar o modesty panel, ver a nota técnica relevante</p>						
 <p><b>modesty panel L.180 cm + canale passacavi in lamiera piegata per tavoli cm 200</b> modesty panel w. 180 cm + cable channels made of sheet metal desks 200 cm panel de protección L.180 cm + canal pasacables en chapa doblada para mesas de 200 cm voile de fond L.180 cm + goulotte en acier plié pour bureaux de 200 cm Modesty Paneel B.180 cm + Kabelkanal aus gebogenem Blech, für Schreibtische 200 cm modesty panel L.180 cm + canal passa-cabos chapa de aço dobrada para mesa escritivaninha cm 200</p>	180 70 7/8"	1,8 3/4"	38 15"	<b>903.MP.17.18</b>	<b>393</b>	<b>425</b>	<b>476</b>	20,80 45,86	0,051 1,80	6 6
				<p><b>Per ordinare il modesty panel vedi relativa nota tecnica</b></p> <p>To order the modesty panel, please check technical notes Para pedir el faldón ver relativa notas técnicas Pour commander le voile de fond, voir note technique Zu bestellen die Knieblende siehe entsprechende technischen Hinweis Para encomendar o modesty panel, ver a nota técnica relevante</p>						

DV913 VIGO  
DV911 NOTO  
DV909 TOKIO  
DV905 RYM  
DV903 TAY

# DV903 Tay

V09 modesty panel  
modesty panel

M1	WN	HH	RC	NM	RS	RM	RT
M2	NO						

L	WL
---	----

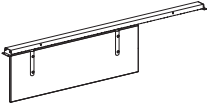
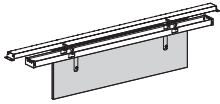
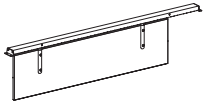
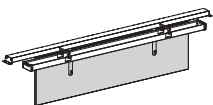
MODESTY PANELS PER TAVOLI VETRO MODESTY PANEL FOR GLASS TABLES	L. W.	P. D.	H. H.	CODICE CODE	V09			Kg. lb	m³ ft³	n. no.	
					M1	M2	L				
 <p><b>modesty panel L.120 cm per scrivanie L. 200 con mobile di servizio</b> modesty panel w.120 cm for desks w. 200 cm with service unit modesty panel L.140 cm para mesa despacho L. 200 cm en vidro con mueble auxiliar voile de fond L.140 cm pour bureaux en verré L. 200 cm avec desserte Knieblende B. 140 cm für Schreibtischen B. 200 cm aus Glas mit Beistellmöbel modesty panel L.140 cm para mesa escritivaninha L. 200 cm em vidro com móvel de serviço</p>	L11	120	1,8	88	903.MP.04.12	277	304	350	14,60	0,032	4
	L14	47 1/4"	3/4"	34 3/4"							
<p><b>Per ordinare il modesty panel vedi relativa nota tecnica</b></p> <p>To order the modesty panel, please check technical notes Para pedir el faldón ver relativa notas técnicas Pour commander le voile de fond, voir note technique Zu bestellen die Knieblende siehe entsprechende technischen Hinweis Para encomendar o modesty panel, ver a nota técnica relevante</p>											
 <p><b>modesty panel L.120 cm + canale passacavi per scrivanie L. 200 in vetro con mobile di servizio</b> modesty panel w. 120 cm + cable channels made of embossed steel rods for glass desks w. 200 cm with service unit modesty panel L. 120 cm para mesa despacho L. 200 cm en vidro con mueble auxiliar voile de fond L.120 cm + goulotte en rond d'acier pour bureaux en verré L.200 cm avec desserte Knieblende B.120 cm + Kabelkanal aus Stahldraht, für Schreibtischen B. 200 cm aus Glas mit Beistellmöbel modesty panel L.120 cm para mesa escritivaninha L. 200 cm em vidro com móvel de serviço</p>	L11	120	1,8	38	903.MP.17.12	364	391	437	17,80	0,043	6
	L14	47 1/4"	3/4"	15"							
<p><b>Per ordinare il modesty panel vedi relativa nota tecnica</b></p> <p>To order the modesty panel, please check technical notes Para pedir el faldón ver relativa notas técnicas Pour commander le voile de fond, voir note technique Zu bestellen die Knieblende siehe entsprechende technischen Hinweis Para encomendar o modesty panel, ver a nota técnica relevante</p>											
 <p><b>modesty panel L.140 cm per scrivanie L.200 in vetro con mobile di servizio</b> modesty panel w.140 cm for glass desks w.200 cm with service unit modesty panel L.140 cm para mesa despacho L. 200 cm en vidro con mueble auxiliar voile de fond L.140 cm pour bureaux en verré L. 200 cm avec desserte Knieblende B. 140 cm für Schreibtischen B.200 cm aus Glas mit Beistellmöbe modesty panel L.140 cm para mesa escritivaninha L. 200 cm em vidro com móvel de serviço</p>	L12	140	1,8	88	903.MP.04.14	292	322	364	15,60	0,034	4
	L15	55 1/8"	3/4"	34 3/4"							
<p><b>Per ordinare il modesty panel vedi relativa nota tecnica</b></p> <p>To order the modesty panel, please check technical notes Para pedir el faldón ver relativa notas técnicas Pour commander le voile de fond, voir note technique Zu bestellen die Knieblende siehe entsprechende technischen Hinweis Para encomendar o modesty panel, ver a nota técnica relevante</p>											
 <p><b>modesty panel L.140 cm + canale passacavi in lamiera piegata per scrivanie L. 200 in vetro con mobile di servizio</b> modesty panel w. 140 cm + cable channels made of sheet metal for glass desks w.200 cm with service unit modesty panel L.140 cm + canal pasacables en chapa doblada para mesa despacho L. 200 cm en vidro con mueble auxiliar voile de fond L.140 cm + goulotte en acier plié pour bureaux en verré L. 200 cm avec desserte Knieblende B. 140 cm + Kabelkanal aus gebogenem Blech, für Schreibtischen B. 200 cm aus Glas mit Beistellmöbel modesty panel L. 140 cm + canal passa-cabos em chapa de aço dobrada para mesa escritivaninha L.200 cm em vidro com móvel de serviço</p>	L12	140	1,8	38	903.MP.18.14	358	388	430	17,90	0,040	6
	L15	55 1/8"	3/4"	15"							
<p><b>Per ordinare il modesty panel vedi relativa nota tecnica</b></p> <p>To order the modesty panel, please check technical notes Para pedir el faldón ver relativa notas técnicas Pour commander le voile de fond, voir note technique Zu bestellen die Knieblende siehe entsprechende technischen Hinweis Para encomendar o modesty panel, ver a nota técnica relevante</p>											



# DV903 Tay

V09 modesty panel  
modesty panel

M1	WN	HH	RC	NM	RS	RM	RT
M2	NO						

L	WL
---	----

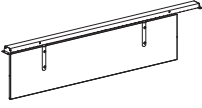
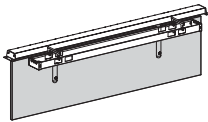
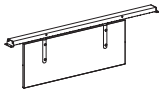
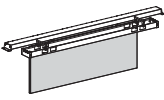
MODESTY PANELS PER TAVOLI VETRO MODESTY PANEL FOR GLASS TABLES	L. W.	P. D.	H. H.	CODICE CODE	V09			Kg. lb	m <sup>3</sup> ft <sup>3</sup>	n. no.	
					M1	M2	L				
 <p><b>modesty panel L.160 cm per scrivanie L. 200 e L. 200 in vetro con mobile di servizio</b> modesty panel w.160 cm for desks w. 200 and glass desks w. 200 cm with service unit modesty panel L.160 cm para mesa L.200 y L. 200 cm en vidrio con mueble auxiliar voile de fond L.160 cm pour bureaux L. 200 et bureaux en verré L.200 cm avec desserte Knieblende B. 160 cm für Schreibtischen B.200 und Schreibtischen B.200 cm aus Glas mit Beistellmöbel modesty panel L.160 cm para mesa escritivaninha L.200 e mesa escritivaninha L.200 cm em vidro com móvel de serviço</p>	L13 L16	160 63"	1,8 3/4"	88 34 3/4"	<b>903.MP.04.16</b>	<b>301</b>	<b>329</b>	<b>375</b>	16,60 36,60	0,037 1,30	4 4
	<p><b>Per ordinare il modesty panel vedi relativa nota tecnica</b></p> <p>To order the modesty panel, please check technical notes Para pedir el faldón ver relativa notas tecnicas Pour commander le voile de fond, voir note technique Zu bestellen die Knieblende siehe entsprechende technischen Hinweis Para encomendar o modesty panel, ver a nota técnica relevante</p>										
 <p><b>modesty panel L.160 cm + canale passacavi in lamiera piegata per tavoli cm 200</b> modesty panel w. 160 cm + cable channels made of sheet metal desks 200 cm panel de protección L.160 cm + canal pasacables en chapa doblada para mesas de 200 cm voile de fond L.160 cm + goulotte en acier plié pour bureaux de 200 cm Modesty Panel B.160 cm + Kabelkanal aus gebogenem Blech, für Schreibtische 200 cm modesty panel L.160 cm + canal passa-cabos chapa de aço dobrada para mesa escritivaninha cm 200</p>	L13 L16	160 63"	1,8 3/4"	38 15"	<b>903.MP.17.16</b>	<b>388</b>	<b>416</b>	<b>462</b>	19,80 43,65	0,048 1,69	6 6
	<p><b>Per ordinare il modesty panel vedi relativa nota tecnica</b></p> <p>To order the modesty panel, please check technical notes Para pedir el faldón ver relativa notas tecnicas Pour commander le voile de fond, voir note technique Zu bestellen die Knieblende siehe entsprechende technischen Hinweis Para encomendar o modesty panel, ver a nota técnica relevante</p>										
 <p><b>modesty panel L.100 cm per scrivanie/riunioni 160x160 in vetro con mobile di servizio</b> modesty panel w.100 cm for glass desks/meeting table 160x160 cm with service unit modesty panel L.100 cm para mesa despacho/ reuniones L. 160x160 cm en vidrio con mueble auxiliar voile de fond L.140 cm pour plateau bureaux/réunion en verré L. 160x160 cm avec desserte Knieblende B. 140 cm für Schreibtischen L.160x160 cm aus Glas mit Beistellmöbel modesty panel L.140 cm para mesa escritivaninha/ reunião L. 160x160 cm DV903 glass com móvel de serviço</p>	L17 L18	100 39 3/8"	1,8 3/4"	88 34 3/4"	<b>903.MP.04.10</b>	<b>256</b>	<b>278</b>	<b>318</b>	13,20 29,10	0,027 0,95	4 4
	<p><b>Per ordinare il modesty panel vedi relativa nota tecnica</b></p> <p>To order the modesty panel, please check technical notes Para pedir el faldón ver relativa notas tecnicas Pour commander le voile de fond, voir note technique Zu bestellen die Knieblende siehe entsprechende technischen Hinweis Para encomendar o modesty panel, ver a nota técnica relevante</p>										
 <p><b>modesty panel L. 100 cm + canale passacavi in lamiera piegata per scrivanie/riunioni 160x160 in vetro con mobile di servizio</b> modesty panel w. 100 cm + cable channels made of sheet metal for glass desks/meeting table 160x160 cm with service unit modesty panel L. 100 cm + canal pasacables en chapa doblada para mesa despacho/reuniones L. 160x160 cm en vidrio con mueble auxiliar voile de fond L.100 cm + goulotte en acier plié pour plateau bureaux/ réunion en verré L. 160x160 cm avec desserte Knieblende B. 100 cm+ Kabelkanal aus gebogenem Blech, für Schreibtischen L.160x160 cm aus Glas mit Beistellmöbel modesty panel L.100 cm + canal passa-cabos em chapa de aço dobrada para mesa escritivaninha/ reunião L. 160x160 cm vidro com móvel de serviço</p>	L17 L18	100 39 3/8"	1,8 3/4"	38 15"	<b>903.MP.17.10</b>	<b>336</b>	<b>358</b>	<b>398</b>	15,90 35,05	0,035 1,23	6 6
	<p><b>Per ordinare il modesty panel vedi relativa nota tecnica</b></p> <p>To order the modesty panel, please check technical notes Para pedir el faldón ver relativa notas tecnicas Pour commander le voile de fond, voir note technique Zu bestellen die Knieblende siehe entsprechende technischen Hinweis Para encomendar o modesty panel, ver a nota técnica relevante</p>										

DV913 VIGO  
DV911 NOTO  
DV909 TOKIO  
DV905 RYM  
DV903 TAY

