

Oslo

DV817



LINEA OPERATIVA

OPERATIVE LINE

SERIE OPERATIVA

LIGNES OPÉRATIONNELLES

BÜROEINRICHTUNGSPROGRAMME

LINHA OPERATIVA

DV817
OSLO

DV805
TREKO

DV818
TOLEDO

DV803
NOBU

DV802
PAG

DV812
ENNA

DV801
ENTITY

DV804
E-PLACE

**con serratura**

with lock
con cerradura
avec serrure
mit Schloss
com fechadura

**articolo non in pronta consegna. Per la disponibilità contattare l'ufficio commerciale**

item not in prompt delivery. Please contact the commercial department for checking availability
producto no disponible en stock. Para la disponibilidad contactar con el departamento comercial
article non disponible en stock. Merci de contacter le service commercial pour vérifier la disponibilité
Dieses Produkt ist nicht sofort lieferbar. Setzen Sie sich mit unserem Handelsbüro in Verbindung für die Warenverfügbarkeit
produtos não pronta entrega. Acerca da disponibilidade, contactar o sector comercial

Piani di lavoro in melaminico sp. 25 mm
 Melamine worktops 25 mm thick
 Sobres de trabajo en melamina 25 mm de grosor
 Plans de travail en melaminé ép. 25 mm
 Tischplatten aus Melamin St. 25 mm
 Planos de trabalho em melaminico esp. 25 mm

V01 M1W	WN	V01 M1	RC	NM
	Bianco White Blanco Blanc Weiss Branco		Rovere chiaro Light oak Roble claro Chêne clair Eiche hell Carvalho claro	Noce "Maroncelli" Walnut "Maroncelli" Nogal "Maroncelli" Noyer "Maroncelli" Nussbaum "Maroncelli" Nogueira "Maroncelli"

Strutture metalliche
 Metal structures
 Estructuras metálicas
 Structures métalliques
 Metallstrukturen
 Estruturas metálicas

V02	W	H	A
	Bianco White Blanco Blanc Weiß Branco	Alluminio Aluminium Aluminio Aluminium Aluminium	Antracite Anthracite Antracita Anthracite Anthrazit Antracite

RO	VS	AP	GO
Rosso mattone Brick red Rojo ladrillo Rouge brique Backstein Rot Vermelho tijolo	Verde salvia Sage green Verde salvia Vert sauge Salbei Grün Verde salvia	Azzurro polvere Powder blue Azul claro Bleu pastel Pulver Blau Azul pó	Giallo oro Gold yellow Amarillo dorado Jaune doré Gold-gelb Amarelo dourado

Particolari in ABS
 Kit of ABS spacers and feet
 Kit con separadores y pies en ABS
 Bouchon pour vérin en ABS
 Satz von ABS Abstandshaltern und Füßen
 Kit com espaçadores e pés ABS

V08	W	G1	A	RO	VS	AP
	Bianco White Blanco Blanc Weiß Branco	Grigio chiaro Light grey Gris claro Gris clair Hellgrau Cinza claro	Antracite Anthracite Antracita Anthracite Anthrazit Antracite	Rosso mattone Brick red Rojo ladrillo Rouge brique Backstein Rot Vermelho tijolo	Verde salvia Sage green Verde salvia Vert sauge Salbei Grün Verde salvia	Azzurro polvere Powder blue Azul claro Bleu pastel Pulver Blau Azul pó

GO
Giallo oro Gold yellow Amarillo dorado Jaune doré Gold-gelb Amarelo dourado

Trave scrivania

Desk beam
Viga de mesa
Poutre pour bureau
Tischbalken
Feixe de mesa

H

Alluminio

Aluminium
Aluminio
Aluminium
Aluminium
Aluminio

Modesty panel sp.18 mm

V09 Modesty panel 18 mm thick
M1 Panel de proteccìon en melamina 18 mm de grosor
Voile de fond en melaminé ép. 18 mm
Knieblende aus Melamin St. 18 mm
Modesty panel en melamínico esp. 18 mm

WN

Bianco

White
Blanco
Blanc
Weiss
Branco

RC

Rovere chiaro

Light oak
Roble claro
Chêne clair
Eiche hell
Carvalho claro

NM

Noce "Maroncelli"

Walnut "Maroncelli"
Nogal "Maroncelli"
Noyer "Maroncelli"
Nussbaum "Maroncelli"
Nogueira "Maroncelli"

Top access Alluminio

V13 Top access Aluminium
Top access Aluminium
Top access Aluminium
Top Access Aluminium
Top access Aluminium



W

Bianco

White
Blanco
Blanc
Weiss
Branco



H

Alluminio

Aluminium
Aluminio
Aluminium
Aluminium
Aluminio



N

Nero anodizzato

Anodized black
Negro anodizado
Noir anodisé
eloxiert Schwarz
Preto anodizado

V01 **CASSETTIERE PORTANTI - Scocche e frontali cassetti in melaminico sp. 18 mm (VEDI SEZIONE "STORAGES")**
V05 CARRYING PEDESTALS - Melamine bodies and fronts 18 mm thick (SEE "STORAGES" PAGES)
 CAJONERAS PORTANTES - Cuerpos en melamina 18 mm de grosor (VER PÁGINAS DE "STORAGES")
M1 CAISSON PORTEUR - Coffres en mélaminé ép. 18 mm (VOIR PAGES "STORAGES")
 TRAGENDES SCHUBLADENELEMENT - Korpus aus Melamin St. 18 mm (SIEHE SEITEN "STORAGE")
 GAVETEIROS PORTANTE - Corpo en melaminico esp. 18 mm (VER PÁGINAS DE "STORAGES")



WN Bianco White Blanco Blanc Weiss Branco	RC Rovere chiaro Light oak Roble claro Chêne clair Eiche hell Carvalho claro	NM Noce "Maroncelli" Walnut "Maroncelli" Nogal "Maroncelli" Noyer "Maroncelli" Nussbaum "Maroncelli" Nogueira "Maroncelli"
--	---	---

V04 **CASSETTIERE PORTANTI - top in melaminico sp. 25 mm**
M1 CARRYING PEDESTALS - Melamine top 25 mm thick
 CAJONERAS PORTANTES - Encimera en melamina 25 mm de grosor
 CAISSON PORTEUR - Top en mélaminé ép. 25 mm
 TRAGENDES SCHUBLADENELEMENT - Abdeckplatte aus Melamin St. 25 mm
 GAVETEIROS PORTANTE - Tampo en melaminico esp. 25 mm



WN Bianco White Blanco Blanc Weiss Branco	RC Rovere chiaro Light oak Roble claro Chêne clair Eiche hell Carvalho claro	NM Noce "Maroncelli" Walnut "Maroncelli" Nogal "Maroncelli" Noyer "Maroncelli" Nussbaum "Maroncelli" Nogueira "Maroncelli"
--	---	---

V10 **CASSETTIERE PORTANTI - Cassetti interni disponibili in melaminico rivestiti in PVC (*) o metallico (**)**
 CARRYING PEDESTALS - Inside drawers available with melamine coated with PVC (*) or metal (**)
 CAJONERAS PORTANTES - Interior de los cajones disponibles en melamina revestida en PVC (*) o en metal (**)
 CAISSON PORTEUR - Intérieur tiroir disponibles en mélaminé revêtus de PVC (*) ou métal (**)
 TRAGENDES SCHUBLADENELEMENT - Interne Schublade verfügbar in folgenden Ausführungen aus Melamin PVC Spanplatte (*) oder Metall (**)
 GAVETEIROS PORTANTE - Gavetas internas disponíveis em melaminico revestidas em PVC (*) ou metálico (**)



DFT * Grigio chiaro (standard) Light grey (standard) Gris claro (standard) Gris clair (standard) Hellgrau (standard) Cinza claro (standard)	AL01 ** Alluminio Aluminium Aluminio Aluminium Aluminium Aluminio
--	--

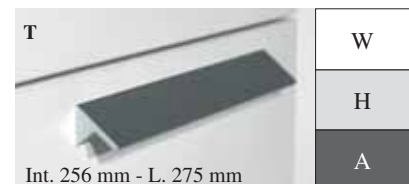
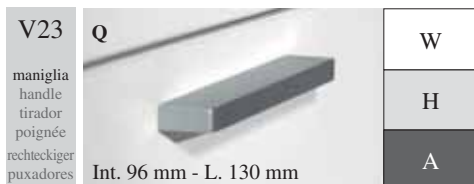

V04

MOBILI DI SERVIZIO - Scocca in melaminico sp.18 mm e ripiani in melaminico sp.18 mm

SERVICE UNITS - Bodies in melamine panels 18 mm thick and shelves in melamine panels 18 mm thick
 MUEBLE AUXILIAR - Cuerpo en melamina de 18 mm de grosor y estantes en melamina de 18 mm de grosor
 DESSERTTE - Coffre en mélaminé ép.18 mm et tablettes en mélaminé ép. 18 mm
 BEISTELLMÖBEL - Korpus aus Melamin St. 18 mm und Einlegeböden aus Melamin St. 18 mm
 MÓVEL DE SERVIÇO - Estrutura em melamínico espessura 18 mm e prateleiras em melamínico espessura 18 mm

WN

Bianco
White
Blanco
Blanc
Weiss
Branco

HH

Alluminio
Aluminium
Aluminio
Aluminium
Aluminium
Aluminio

AN

Antracite
Anthracite
Antracita
Anthracite
Anthrazit
Antracite

V05

M1

MOBILI DI SERVIZIO - Ante scorrevoli in melaminico sp.18 mm

SERVICE UNITS - Melamine sliding doors 18 mm thick
 MUEBLE AUXILIAR - Puertas correderas en melamina de 18 mm de grosor
 DESSERTTE - Portes coulissantes en mélaminé ép. 18 mm
 BEISTELLMÖBEL - Schiebetüren aus Melamin St. 18 mm
 MÓVEL DE SERVIÇO - Portas de correr em melamínico esp. 18 mm

Ante bordate in ABS perimetrale, colore ALLUMINIO (H)

Doors with perimeter edge banding in ABS, ALUMINIUM colour (H)
 Puertas cantos perimétricos en ABS, color ALUMINIO (H)
 Portes avec chants de périmètre en ABS, couleur ALUMINIUM (H)
 Türen mit ABS Kante, ALUMINIUM (H) Farbe
 Portas orladas a ABS perimetral, cor ALUMÍNIO (H)

AT

Azzurro turchese
Turquoise blue
Azul turquesa
Bleu turquoise
Türkisblau
Azul turquesa

GS

Giallo senape
Mustard yellow
Amarillo mostaz
Jaune moutarde
Senfgeb
Amarela mostarda

RP

Rosso papavero
Poppy red
Rojo amapola
Rouge coquelicot
Mohnrot
Vermelho papoula

TD

Terra d'ombra
Umber
Tierra sombra
Terre d'ombre
Umbr
Terra sombra

VB

Verde bambú
Bamboo green
Verde bambú
Vert bambou
Bambusgrün
Verde bambú

Ante bordate in ABS perimetrale, colore IN TINTA CON LE ANTE

Doors with perimeter edge banding in ABS, WITH MATCHING DOOR COLOUR
 Puertas cantos perimétricos en ABS, ACABADO COORDINADO A LAS PUERTAS
 Portes avec chants de périmètre en ABS, FINITION COORDONNEE AUX PORTES
 Türen mit ABS Kante, PASSEND ZU DER TÜR FARBE
 Portas orladas a ABS perimetral, À MESMA COR QUE A DAS PORTAS

WN

Bianco
White
Blanco
Blanc
Weiss
Branco

HH

Alluminio
Aluminium
Aluminio
Aluminium
Aluminium
Aluminio

RC

Rovere chiaro
Light oak
Roble claro
Chêne clair
Eiche hell
Carvalho claro

NM

Noce "Maroncelli"
Walnut "Maroncelli"
Nogal "Maroncelli"
Noyer "Maroncelli"
Nussbaum "Maroncelli"
Nogueira "Maroncelli"

V05
M2

NO

Nero opaco
Matt black
Negro mate
Noir mat
Schwarz matt
Preto opaco

V01 **CONTENTORI COMPLANARI - Scocche in melaminico sp. 18 mm (VEDI SEZIONE "STORAGES")**
 COPLANAR STORAGE UNIT - Melamine bodies 18 mm thick (SEE "STORAGES" PAGES)
 CONTENEDOR COPLANAR - Puertas en melamina 18 mm de grosor (VER PÁGINAS DE "STORAGES")
 MEUBLE COPLANAIRE - Coffres en melaminé ép. 18 mm (VOIR PAGES "STORAGES")
 SCHRANK KOMPLANAREN - Korpus aus Melamin St. 18 mm (SIEHE SEITEN "STORAGE")
 ARMARIO COPLANARES - Corpo en melaminico esp. 18 mm (VER PÁGINAS DE "STORAGES")



WN Bianco White Blanco Blanc Weiss Branco	HH Alluminio Aluminium Aluminio Aluminium Aluminio	AN Antracite Anthracite Antracita Anthracite Anthrazit Antracite
--	--	---

V05 **CONTENTORI COMPLANARI - Ante in melaminico sp. 18 mm**
 COPLANAR STORAGE UNIT - Melamine doors 18 mm thick
 CONTENEDOR COPLANAR - Puertas en melamina 18 mm de grosor
 MEUBLE COPLANAIRE - Portes de travail en melaminé ép. 18 mm
 SCHRANK KOMPLANAREN - Türen aus Melamin St. 18 mm
 ARMARIO COPLANARES - Portas en melaminico esp. 18 mm

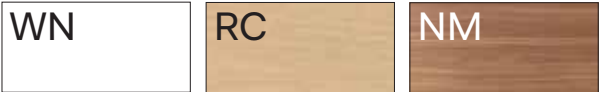

WN Bianco White Blanco Blanc Weiss Branco	RC Rovere chiaro Light oak Roble claro Chêne clair Eiche hell Carvalho claro	NM Noce "Maroncelli" Walnut "Maroncelli" Nogal "Maroncelli" Noyer "Maroncelli" Nussbaum "Maroncelli" Nogueira "Maroncelli"
--	---	---

V04 **CONTENTORI COMPLANARI - top in melaminico sp. 25 mm**
 COPLANAR STORAGE UNIT - Melamine top 25 mm thick
 CONTENEDOR COPLANAR - Encimera en melamina 25 mm de grosor
 MEUBLE COPLANAIRE - Top en melaminé ép. 25 mm
 SCHRANK KOMPLANAREN - Abdeckplatte aus Melamin St. 25 mm
 ARMARIO COPLANARES - Tampo en melaminico esp. 25 mm

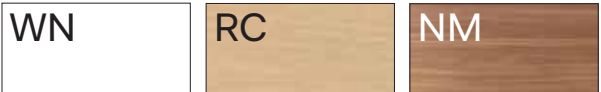

WN Bianco White Blanco Blanc Weiss Branco	RC Rovere chiaro Light oak Roble claro Chêne clair Eiche hell Carvalho claro	NM Noce "Maroncelli" Walnut "Maroncelli" Nogal "Maroncelli" Noyer "Maroncelli" Nussbaum "Maroncelli" Nogueira "Maroncelli"
--	---	---

V23
maniglia
handle
tirador
poignée
rechteckiger
puxadores

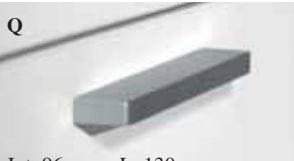
Q  **W**
H
A
 Int. 96 mm - L. 130 mm

V  **W**
H
A
 Int. 256 mm - L. 275 mm

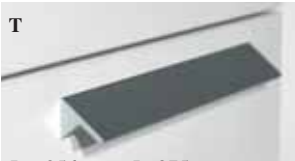
T  **W**
H
A
 Int. 256 mm - L. 275 mm

DV817 Oslo

Finiture - finishes - acabados - finitions - farben - acabamentos

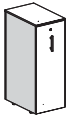
V04  **ORGATOWER - Scocche in melaminico sp. 18 mm**
 ORGATOWER - Melamine bodies 18 mm thick
 ORGATOWER - Cuerpos en melamina 18 mm de grosor
 ORGATOWER - Coffres en melaminé ép. 18 mm
 ORGATOWER - Korpus aus Melamin St. 18 mm
 ORGATOWER - Corpo en melaminico esp. 18 mm



Bianco
 White
 Blanco
 Blanc
 Weiss
 Branco



Alluminio
 Aluminium
 Aluminio
 Aluminium
 Aluminium
 Aluminio

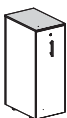

Antracite
 Anthracite
 Antracita
 Anthracite
 Anthrazit
 Antracite

V01
M1  **ORGATOWER - Top in melaminico sp. 25 mm**
 ORGATOWER - Top 25 mm thick
 ORGATOWER - Encimeras en melamina 25 mm de grosor
 ORGATOWER - Tops en melaminé ép. 25 mm
 ORGATOWER - Abdeckplatte aus Melamin St. 25 mm
 ORGATOWER - Tampos en melaminico esp. 25 mm



Bianco
 White
 Blanco
 Blanc
 Weiß
 Branco



Noce "Maroncelli"
 Walnut "Maroncelli"
 Nogal "Maroncelli"
 Noyer "Maroncelli"
 Nussbaum "Maroncelli"
 Nogueira "Maroncelli"

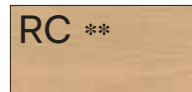

Rovere chiaro
 Light oak
 Roble claro
 Chêne clair
 Eiche hell
 Carvalho claro



Terra d'ombra
 Umber
 Tierra sombra
 Terre d'ombre
 Umбра
 Terra sombra

V01
M2 **NO****

Nero opaco
 Black matt
 Negro mate
 Noir mat
 Schwarz matt
 Preto opaco

**** Top bordati in ABS perimetrale, COLORE IN TINTA CON I TOP**
 Tops with perimeter edge banding in ABS, WITH MATCHING TOP COLOUR
 Encimeras con cantos perimétricos en ABS, ACABADO COORDINADO A LAS ENCIMERAS
 Tops avec chants de périmètre en ABS, FINITION COORDONNEE AUX TOPS
 Abdeckplatte mit ABS Kante, PASSEND ZU DER ABDECKPLATTE FARBE
 Tampos orladas a ABS perimetral, À MESMA COR QUE A DAS TAMPOS

V23  **ORGATOWER - Maniglia per ante**
 ORGATOWER - Handle for doors
 ORGATOWER - Tirador para puerta
 ORGATOWER - Poignée pour porte
 ORGATOWER - Standardgriff für Türen
 ORGATOWER - Puxadores para portas

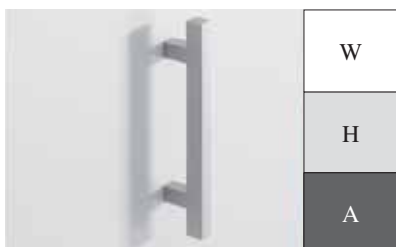

V81

ORGATOWER - Anta singola : maniglia lato SINISTRO (SX) o lato DESTRO (DX)

ORGATOWER - Single door : handle LEFT hand (SX) or RIGHT hand (DX)
 ORGATOWER - Puerta : tirador lado izq (SX) o lado drch (DX)
 ORGATOWER - Porte : poignée côté GAUCHE (SX) ou côté DROITE (DX)
 ORGATOWER - Tür : griff LINKS (SX) oder RECHT (DX)
 ORGATOWER - Porta : puxadored lateral ISQUIERDA (SX) ou lateral DIREITO (DX)

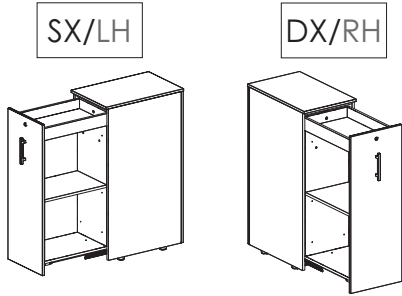

V05
M1

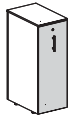

ORGATOWER - Frontali in melaminico sp. 18 mm

ORGATOWER - Melamine drawers 18 mm thick
 ORGATOWER - Frontales en melamina 18 mm de grosor
 ORGATOWER - Frontale en melaminé ép. 18 mm
 ORGATOWER - Türen aus Melamin St. 18 mm
 ORGATOWER - Frontal en melaminico esp. 18 mm



Bianco
 White
 Blanco
 Blanc
 Weiß
 Branco

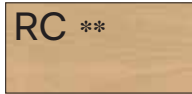

Rovere chiaro
 Light oak
 Roble claro
 Chêne clair
 Eiche hell
 Carvalho claro



Noce "Maroncelli"
 Walnut "Maroncelli"
 Nogal "Maroncelli"
 Noyer "Maroncelli"
 Nussbaum "Maroncelli"
 Nogueira "Maroncelli"



Azzurro turchese
 Turquoise blue
 Azul turquesa
 Bleu turquoise
 Türkisblau
 Azul turquesa



Giallo senape
 Mustard yellow
 Amarillo mostaz
 Jaune moutarde
 Senfgelb
 Amarela mostarda



Rosso papavero
 Poppy red
 Rojo amapola
 Rouge coquelicot
 Mohnrot
 Vermelho papoula



Verde bambú
 Bamboo green
 Verde bambú
 Vert bambou
 Bambusgrün
 Verde bambú



Terra d'ombra
 Umber
 Tierra sombra
 Terre d'ombre
 Umbra
 Terra sombra

V05
M2



Nero opaco
 Black matt
 Negro mate
 Noir mat
 Schwarz matt
 Preto opaco

* **Frontali bordati in ABS perimetrale, colore ALLUMINIO (H)**
 Drawers with perimeter edge banding in ABS, ALUMINIUM colour (H)
 Frontales con cantos perimétricos en ABS, color ALUMINIO (H)
 Frontales avec chants de périmètre en ABS, couleur ALUMINIUM (H)
 Türen mit ABS Kante, ALUMINIUM (H) Farbe
 Frontales orladas a ABS perimetral, cor ALUMINIO (H)

** **Frontali bordati in ABS perimetrale, colore IN TINTA CON LE ANTE**
 Drawers with perimeter edge banding in ABS, WITH MATCHING DOOR COLOUR
 Frontales con cantos perimétricos en ABS, ACABADO COORDINADO A LAS PUERTAS
 Frontales avec chants de périmètre en ABS, FINITION COORDONNEE AUX PORTES
 Türen mit ABS Kante, PASSEND ZU DER TÜR FARBE
 Frontales orladas a ABS perimetral, À MESMA COR QUE A DAS PORTAS

DV817 Oslo

M1W	V01 piani worktops	WN						
	V02 gambe legs	W	H	A	RO	VS	AP	GO
	V08 kit kit	W	G1	A	RO	VS	AP	GO

M1	V01 piani worktops	RC	NM					
	V02 gambe legs	W	H	A	RO	VS	AP	GO
	V08 kit kit	W	G1	A	RO	VS	AP	GO

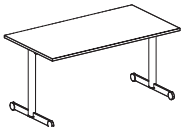
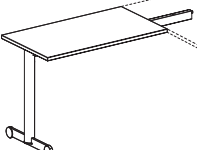
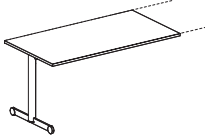
SCRIVANIA DESKS	L. W.	P. D.	H. H.	CODICE CODE	CATEGORIA PREZZO / PRICE CATEGORY		Kg. lb	m³ ft³	n. no.
					M1W	M1			
 <p>Scrivania Desk mesa despacho bureau Schreibtisch mesa escrivaninha</p>	80 31 1/2"	55 21 3/4"	74 29 1/4"	817.TS.71.08	236	245	11,00 24,25	0,023 0,81	3 3
	100 39 3/8"	55 21 3/4"	74 29 1/4"	817.TS.71.10	247	257	13,40 29,54	0,029 1,02	3 3
	120 47 1/4"	80 31 1/2"	74 29 1/4"	817.TS.02.12	284	301	28,80 63,50	0,233 8,23	5 5
	140 55 1/8"	80 31 1/2"	74 29 1/4"	817.TS.02.14	292	308	32,10 70,78	0,154 5,44	5 5
	160 63"	80 31 1/2"	74 29 1/4"	817.TS.02.16	302	335	34,10 75,19	0,163 5,75	5 5
	180 70 7/8"	80 31 1/2"	74 29 1/4"	817.TS.02.18	331	353	38,60 85,11	0,172 6,07	5 5
 <p>Dattilo collegabile lateralmente Desk return ala acoplable lateralmente Retour suspendu Schreibmaschinentisch für seitliche Verbindung mesa para teclado com encaixe lateral</p>	80 31 1/2"	55 21 3/4"	74 29 1/4"	817.TD.71.08	177	186	15,60 34,39	0,060 2,12	4 4
	100 39 3/8"	55 21 3/4"	74 29 1/4"	817.TD.71.10	189	199	18,00 39,69	0,066 2,33	4 4
 <p>Scrivania collegabile in linea extension table connectible in line mesa despacho acoplable en línea bureau suspendu en ligne anstellbarer Schreibmaschinentisch mesa para teclado acoplável em paralelo</p>	120 47 1/4"	80 31 1/2"	74 29 1/4"	817.TS.06.12	245	262	25,50 56,22	0,218 7,70	4 4
	140 55 1/8"	80 31 1/2"	74 29 1/4"	817.TS.06.14	253	269	28,80 63,50	0,139 4,91	4 4
	160 63"	80 31 1/2"	74 29 1/4"	817.TS.06.16	263	296	30,80 67,91	0,148 5,22	4 4
	180 70 7/8"	80 31 1/2"	74 29 1/4"	817.TS.06.18	292	314	35,30 77,83	0,157 5,54	4 4

V01 piani worktops	WN	RC	NM
--------------------	----	----	----

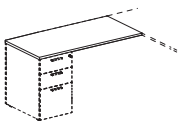
ALLUNGO LATERALE EXTENSION TABLE	L.	P.	H.	CODICE CODE	V01	Kg. lb	m ³ ft ³	n. no.
	W.	D.	H.					
 <p>allungo laterale (cassettiera portante da ordinare a parte) extension table (carrying pedestal to be ordered separately) alargó lateral (la cajonera portante es para pedir a parte) retour latéral (caisson porteur à commander à part) Seitliche Tischverlängerung (tragendes Schubladenelement muss separat bestellt werden) extensão lateral (gaveteiro portante devem ser pedidos separadamente)</p>	100 39 3/8"	65 25 5/8"	74 29 1/4"	817.AL.01.10	119	13,30 29,32	0,038 1,34	2 2

NOTE: CASSETTIERE PORTANTI - VEDI SEZIONE "STORAGES"

CARRYING PEDESTALS - SEE "STORAGES" PAGES
 CAJONERAS PORTANTES - VER PÁGINAS DE "STORAGES"
 CAISSON PORTEUR - VOIR PAGES "STORAGES"
 TRAGENDES SCHUBLADENELEMENT - SIEHE SEITEN "STORAGE"
 GAVETEIROS PORTANTE - VER PÁGINAS DE "STORAGES"

M1W	V01 piani worktops	WN						
	V02 gambe legs	W	H	A	RO	VS	AP	GO
	V08 kit kit	W	G1	A	RO	VS	AP	GO

M1	V01 piani worktops	RC	NM					
	V02 gambe legs	W	H	A	RO	VS	AP	GO
	V08 kit kit	W	G1	A	RO	VS	AP	GO

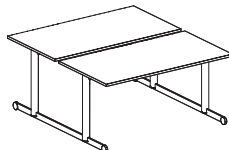
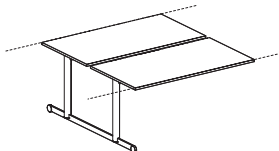
TAVOLI BENCH BENCH DESKS	L. W.	P. D.	H. H.	CODICE CODE	CATEGORIA PREZZO / PRICE CATEGORY		Kg. lb	m ³ ft ³	n. no.
					M1W	M1			
 <p>2 scrivanie "bench" contrapposte 2 desk "bench" composition 2 mesas "bench" enfrentadas "bench" 2 bureaux v/v "Bench" Schreibtisch mit 2 gegenüber angeordneten Tischen mesa 2 escritivanhas "bench" contrapostas</p>	140 55 1/8"	166,5 65 5/8"	74 29 1/4"	817.TB.06.14	572	604	64,40 142,00	0,330 11,66	7 7
	160 63"	166,5 65 5/8"	74 29 1/4"	817.TB.06.16	592	658	68,40 150,82	0,348 12,29	7 7
	180 70 7/8"	166,5 65 5/8"	74 29 1/4"	817.TB.06.18	650	694	77,40 170,66	0,366 12,93	7 7
 <p>2 scrivanie "bench" contrapposte collegabile in linea 2 desk "bench" composition connectible in line 2 mesas "bench" acoplable en línea "bench" 2 bureaux v/v liaison en ligne "Bench" Verbindungsschreibtisch mit 2 gegenüber angeordneten Tischen mesa 2 escritivanhas "bench" contrapostas acoplável em paralelo</p>	140 55 1/8"	166,5 65 5/8"	74 29 1/4"	817.TB.16.14	466	498	56,80 125,24	0,265 9,36	6 6
	160 63"	166,5 65 5/8"	74 29 1/4"	817.TB.16.16	486	552	60,80 134,06	0,283 10,00	6 6
	180 70 7/8"	166,5 65 5/8"	74 29 1/4"	817.TB.16.18	544	588	69,80 153,90	0,301 10,63	6 6

DV817 Oslo

M1W	V01 piani worktops	WN						
	V02 gambe legs	W	H	A	RO	VS	AP	GO
	V08 kit kit	W	G1	A	RO	VS	AP	GO

M1	V01 piani worktops	RC	NM					
	V02 gambe legs	W	H	A	RO	VS	AP	GO
	V08 kit kit	W	G1	A	RO	VS	AP	GO

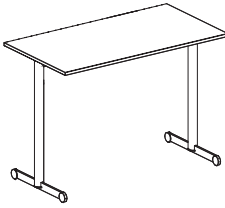
TAVOLI SCRIVANIA DESKS	L. W.	P. D.	H. H.	CODICE CODE	CATEGORIA PREZZO / PRICE CATEGORY		Kg. lb	m³ ft³	n. no.
					M1W	M1			
 <p>Tavolo H.107 cm</p> <p>Table H.107 cm</p> <p>Mesa despacho H.107 cm</p> <p>Table haute H.107 cm</p> <p>Tisch H.107 cm</p> <p>Mesa H.107 cm</p>	140 55 1/8"	80 31 1/2"	107 42 1/4"	817.TA.02.14	340	356	34,50 76,07	0,198 6,99	5 5
	160 63"	80 31 1/2"	107 42 1/4"	817.TA.02.16	350	383	36,50 80,48	0,207 7,31	5 5
	180 70 7/8"	80 31 1/2"	107 42 1/4"	817.TA.02.18	379	401	41,00 90,40	0,216 7,63	5 5

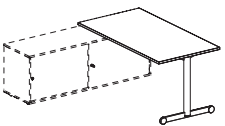
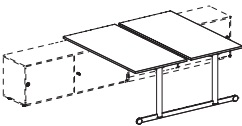
TAVOLI INTEGRABILI PER MOBILE DI SERVIZIO INTEGRABLE DESKS FOR SERVICE UNITS	L. W.	P. D.	H. H.	CODICE CODE	CATEGORIA PREZZO / PRICE CATEGORY		Kg. lb	m³ ft³	n. no.
					M1W	M1			
 <p>Tavoli scrivania per integrazione con mobile di servizio</p> <p>desk to be completed with service unit</p> <p>mesa para integración con mueble auxiliar</p> <p>bureau pour intégration avec meuble de service</p> <p>Schreibtisch für Ergänzung mit Beistellmöbel</p> <p>mesa escritivanha para integrar com móvel de serviço</p>	140 55 1/8"	80 31 1/2"	74 29 1/4"	817.TI.02.14	278	294	29,80 65,70	0,164 5,79	5 5
	160 63"	80 31 1/2"	74 29 1/4"	817.TI.02.16	286	319	31,90 70,33	0,173 6,11	5 5
	180 70 7/8"	80 31 1/2"	74 29 1/4"	817.TI.02.18	312	334	36,20 79,82	0,182 6,43	5 5
 <p>Tavoli scrivania "bench" per integrazione con mobile di servizio</p> <p>bench desk composition, to be completed with service unit</p> <p>2 mesas enfrentadas, para integración con mueble auxiliar</p> <p>2 bureaux v/v, pour intégration au meuble de service</p> <p>"Bench" Schreibtisch mit 2 gegenüber angeordneten Tischplatten, für Ergänzung mit Beistellmöbel</p> <p>mesa 2 escritivanhas "bench" contrapostas, para integrar com móvel de serviço</p>	140 55 1/8"	166,5 65 5/8"	74 29 1/4"	817.TI.05.14	540	572	59,30 130,75	0,338 11,94	8 8
	160 63"	166,5 65 5/8"	74 29 1/4"	817.TI.05.16	556	622	63,50 140,01	0,356 12,57	8 8
	180 70 7/8"	166,5 65 5/8"	74 29 1/4"	817.TI.05.18	608	652	72,10 158,98	0,374 13,21	8 8

M1	V04 scocche bodies	WN	HH	AN						
	V05 ante doors	WN	HH	AT	GS	RP	TD	VB	RC	NM

M2	V04 scocche bodies	WN	HH	AN
	V05 ante doors	NO		

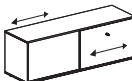
MOBILI DI SERVIZIO SERVICE UNITS	L. W.	P. D.	H. H.	CODICE CODE	CATEGORIA PREZZO / PRICE CATEGORY		Kg. lb	m ³ ft ³	n. no.
					M1	M2			
 <p>mobile di servizio dx/sx con 2 ante scorrevoli bifacciali alternate integrabili con i tavoli scrivanie service unit with 2 bifacial and opposed sliding doors or single-sided sliding door mueble auxiliar dch/izq con 2 puertas correderas dos caras alternadas meuble de service dx/gx avec 2 portes coul.bi-face opposées Beistellmöbel rechts/links mit 2 Beidseitig Schiebetüren - mit den Tischen verbunden móvel de serviço dir. / esq. com 2 folhas deslizáveis faces duplas alternadas</p>	FO 160 63"	48 19"	58 22 7/8"	817.MS.01.16	785	808	65,90 145,30	0,165 5,83	3 3
 <p>mobile di servizio dx/sx con 2 ante scorrevoli monofacciali integrabili con i tavoli scrivanie Right/left service unit with single sided 2 sliding doors mueble auxiliar dch/izq con 2 puertas correderas una-cara integrables con mesas meuble de service dx/gx avec 2 portes coulissantes mono face à intégrer aux bureaux Beistellmöbel rechts/links mit 2 Einseitig Schiebetüren für Schreibtische móvel de serviço dir. / esq. com 2 folhas deslizáveis single-face</p>	FO 160 63"	48 19"	58 22 7/8"	817.MS.02.16	701	734	62,70 138,25	0,158 5,58	3 3

V04 cassetto drawer	WN	HH	AN
---------------------	----	----	----

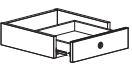
MOBILI DI SERVIZIO SERVICE UNITS	L. W.	P. D.	H. H.	CODICE CODE	V04	Kg. lb	m ³ ft ³	n. no.
 <p>cassetto per mobile di servizio (optional) - senza serratura drawer for service unit (optional) - without lock cajon para mueble auxiliar (opcional) - sin cerradura tiroir pour desserte (en option) - pas de serrure Schublade für Beistellschrank (Optional) - Ohne Schloss gaveta para móvel de serviço (opcional) - sem fechadura</p>	35 13 7/8"	45 17 3/4"	10 4"	817.CA.01.03	106	7,00 15,43	0,038 1,34	1 1

DV817 Oslo

M1W	V01 piani worktops	WN						
	V02 gambe legs	W	H	A	RO	VS	AP	GO
	V08 kit kit	W	G1	A	RO	VS	AP	GO

M1	V01 piani worktops	RC	NM					
	V02 gambe legs	W	H	A	RO	VS	AP	GO
	V08 kit kit	W	G1	A	RO	VS	AP	GO

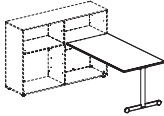
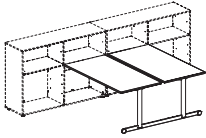
TAVOLI INTEGRABILI CON RIO DV505 INTEGRABLE DESKS WITH RIO DV505	L. W.	P. D.	H. H.	CODICE CODE	CATEGORIA PREZZO / PRICE CATEGORY		Kg. lb	m ³ ft ³	n. no.
					M1W	M1			
 <p>Scrivania da integrare a contenitori Rio_DV505 H= 74 - 115 - 164,5 cm</p> <p>Desk to connect on Rio_DV505 H= 74 - 115 - 164,5 cm</p> <p>Mesa despacho para la integración con Rio_DV505 H= 74 - 115 - 164,5 cm</p> <p>Bureau suspendu à intégrer avec Rio_DV505 Orgatower H= 74 - 115 - 164,5 cm</p> <p>Schreibtisch zur Integration mit Rio_DV505 H= 74 - 115 - 164,5 cm</p> <p>Mesa escritivaninha para integração com Rio_DV505 H= 74 - 115 164,5 cm</p>	140 55 1/8"	80 31 1/2"	74 29 1/4"	817.TI.24.14	265	281	28,90 63,72	0,112 3,95	5 5
	160 63"	80 31 1/2"	74 29 1/4"	817.TI.24.16	273	306	31,00 68,35	0,121 4,27	5 5
	180 70 7/8"	80 31 1/2"	74 29 1/4"	817.TI.24.18	299	321	35,30 77,83	0,130 4,59	5 5
 <p>Bench per integrazioni con contenitori Rio_DV505 H= 74 - 115 - 164,5 cm</p> <p>Bench 2P to connect on Rio_DV505 H= 74 - 115 - 164,5 cm</p> <p>bench enfrentadas para la integración con Rio_DV505 H= 74 - 115 - 164,5 cm</p> <p>1 bench pour 2 personnes à intégrer avec Rio_DV505 H= 74 - 115 - 164,5 cm</p> <p>1 Doppeltisch, einander gegenüberliegend mit Rio_DV505 H= 74 - 115 - 164,5 cm</p> <p>bench com 2 escritivaninhas contrapostas para integração com Rio_DV505 Orgatower H= 74 - 115 - 164,5 cm</p>	140 55 1/8"	166,5 65 5/8"	74 29 1/4"	817.TI.25.14	514	546	57,50 126,78	0,234 8,26	8 8
	160 63"	166,5 65 5/8"	74 29 1/4"	817.TI.25.16	530	596	61,70 136,04	0,252 8,90	8 8
	180 70 7/8"	166,5 65 5/8"	74 29 1/4"	817.TI.25.18	582	626	70,30 155,01	0,270 9,54	8 8

DV817 Oslo

M1W	V01 piani worktops	WN						
	V02 gambe legs	W	H	A	RO	VS	AP	GO
	V08 kit kit	W	G1	A	RO	VS	AP	GO

M1	V01 piani worktops	RC	NM					
	V02 gambe legs	W	H	A	RO	VS	AP	GO
	V08 kit kit	W	G1	A	RO	VS	AP	GO

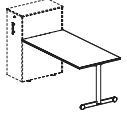
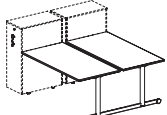
TAVOLI INTEGRABILI CON RIO DV505 INTEGRABLE DESKS WITH RIO DV505	L. W.	P. D.	H. H.	CODICE CODE	CATEGORIA PREZZO / PRICE CATEGORY		Kg. lb	m ³ ft ³	n. no.
					M1W	M1			
 <p>Scrivania da integrare con orgatower Rio_DV505 H= 74-115 cm Desk to connect on Rio_DV505 orgatower H= 74-115 cm Mesa despacho para la integración con Rio_DV505 Orgatower H= 74-115 cm Bureau suspendu à intégrer avec Rio_DV505 Orgatower H= 74-115 cm Schreibtisch zur Integration mit Rio_DV505 Orgatower H= 74-115 cm Mesa escrivaninha para integração com Rio_DV505 Orgatower H= 74-115 cm</p>	140 55 1/8"	80 31 1/2"	74 29 1/4"	817.TI.26.14	285	301	29,40 64,82	0,113 3,99	5 5
	160 63"	80 31 1/2"	74 29 1/4"	817.TI.26.16	293	326	31,50 69,45	0,122 4,31	5 5
	180 70 7/8"	80 31 1/2"	74 29 1/4"	817.TI.26.18	319	341	35,80 78,93	0,131 4,62	5 5
 <p>Bench per integrazioni con orgatower Rio_DV505 H= 74-115 cm Bench 2P to connect on Rio_DV505 orgatower H= 74-115 cm 2 mesas enfrentadas para la integración con Rio_DV505 Orgatower H= 74-115 cm 1 bench pour 2 personnes à intégrer avec Rio_DV505 Orgatower H= 74-115 cm 1 Doppeltisch, einander gegenüberliegend mit Rio_DV505 Orgatower H= 74-115 cm Bench com 2 escrivaninhas contrapostas para integração com Rio_DV505 Orgatower H= 74-115 cm</p>	140 55 1/8"	166,5 65 5/8"	74 29 1/4"	817.TI.27.14	554	586	58,50 128,99	0,236 8,33	8 8
	160 63"	166,5 65 5/8"	74 29 1/4"	817.TI.27.16	570	636	62,70 138,25	0,254 8,97	8 8
	180 70 7/8"	166,5 65 5/8"	74 29 1/4"	817.TI.27.18	622	666	71,30 157,21	0,272 9,61	8 8

DV804 E-PLACE
DV801 ENTITY
DV812 ENNA
DV802 PAG
DV803 NOBU
DV818 TOLEDO
DV805 TREKO
DV817 OSLO

DV817 Oslo

V01 top top	M1	WN	RC	NM	TD
	M2	NO			

V04 scocche bodies	WN	HH	AN
--------------------------	----	----	----

V81 Verso Hand	Sx	Dx
----------------------	----	----

V05 frontali drawers	M1	WN	RC	NM	AT	GS	RP	TD	VB
	M2	NO							



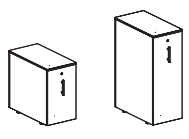

V23 maniglia handle		W
		H
		A

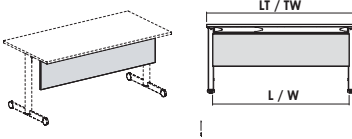
ORGATOWER ORGATOWER	L. W.	P. D.	H. H.	CODICE CODE	CATEGORIA PREZZO PRICE CATEGORY		Kg. lb	m ³ ft ³	n. no.
					M1	M2			
 <p>H.74 / P.80 H.45 3/4" D.31 1/2"</p> <p>H.115 / P.80 H.60 3/4" D.31 1/2"</p> <p>Cassettoni a estrazione totale del frontale Drawers with total frontal extraction Cajoneras con extracción frontal total Caissons à extraction frontale totale Vollauszug Schubkästen Gavetão com extração total do frontal</p>	42 16 5/8"	80 31 1/2"	74 29 1/4"	505.TW.02.03	908	946	30,60 67,47	0,308 10,88	5 5
	42 16 5/8"	80 31 1/2"	115 45 3/8"	505.TW.04.03	1.158	1.196	42,60 93,93	0,485 17,13	5 5

M1	V09 modesty panel	WN	RC	NM
----	-------------------------	----	----	----

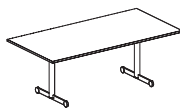
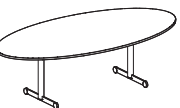
MODESTY PANELS MODESTY PANELS	LT TW	L. W.	P. D.	H. H.	CODICE CODE	CATEGORIA PREZZO / PRICE CATEGORY		Kg. lb	m ³ ft ³	n. no.
						M1	M2			
 <p>Modesty panel per scrivanie modesty panel for desks panel de protección para mesas voile de fond pour bureaux Knieblende für Tisch modesty panel para mesa</p>	120 47 1/4"	107 42 1/4"	1,8 3/4"	35 13 7/8"	817.MP.01.12	87	7,95 17,52	0,016 0,56	2 2	
	140 55"	127 50 1/8"	1,8 3/4"	35 13 7/8"	817.MP.01.14	91	8,45 18,63	0,019 0,67	2 2	
	160 63"	147 57 7/8"	1,8 3/4"	35 13 7/8"	817.MP.01.16	96	8,95 19,73	0,023 0,81	2 2	
	180 70 3/4"	167 65 3/4"	1,8 3/4"	35 13 7/8"	817.MP.01.18	98	9,35 20,61	0,025 0,88	2 2	

M1	V01 piani worktops	WN	RC	NM				
	V02 gambe legs	W	H	A	RO	VS	AP	GO
	V08 kit kit	W	G1	A	RO	VS	AP	GO

TAVOLI RIUNIONE CONFERENCE TABLES	L.	P.	H.	CODICE CODE	CATEGORIA PREZZO PRICE CATEGORY	Kg. lb	m ³ ft ³	n. no.	
	W.	D.	H.		M1				
 <p>Tavolo riunioni con gambe rientrate</p> <p>conference table with recessed legs</p> <p>mesa de reuniones con 2 patas reentradas</p> <p>table réunion sur 2 pieds-colonnes en métal avec pieds retourné</p> <p>Besprechungstisch en retrait</p> <p>mesa de reunião sobre 2 pedestais em metal na cor alumínio com pernas retornada</p>	200 78 3/4"	100 39 3/8"	74 29 1/4"	817.TR.32.20	371	48,50 106,94	0,192 6,78	5 5	
	240 94 1/2"	120 47 1/4"	74 29 1/4"	817.TR.32.24	528	58,10 128,11	0,230 8,12	5 5	
 <p>Tavolo riunioni ovale su 2 gambe</p> <p>oval conference table with 2 legs</p> <p>mesa de reuniones oval con dos patas</p> <p>table réunion ovale sur 2 piétements</p> <p>ovaler Besprechungstisch auf Paar Abschlussbeine</p> <p>mesa de reunião oval sobre 2 pernas</p>	250 98 1/2"	125 49 1/4"	74 29 1/4"	817.TR.34.25	530	56,70 125,02	0,240 8,48	5 5	
 <p>Tavolo riunioni circolare su gambone in metallo</p> <p>round meeting table on metal column</p> <p>mesa reuniones circular con pata metálica</p> <p>table réunion ronde sur pied tulipe en métal</p> <p>runde Besprechungstische auf Metallsäule</p> <p>mesas de reunião circulares com pedestal em metal</p>	100 39 3/8"	100 39 3/8"	74 29 1/4"	817.TR.01.10	358	23,10 50,93	0,058 2,04	3 3	
	120 47 1/4"	120 47 1/4"	74 29 1/4"	817.TR.01.12	386	27,00 59,53	0,076 2,68	3 3	
 <p>tavolo riunioni su 2 gamboni in metallo</p> <p>rectangular meeting tables on 2 metal columns</p> <p>mesa reuniones rectangular con 2 patas cilíndricas metálicas</p> <p>table de réunion rectangulaire sur 2 pieds tulipe en métal</p> <p>Rechteckige Besprechungstische auf 2 Metallsäulen</p> <p>mesas de reunião rectangulares sobre 2 pedestais em metal</p>	200 78 3/4"	100 39 3/8"	74 29 1/4"	817.TR.02.20	565	50,30 110,91	0,112 3,95	5 5	
	240 94 1/2"	120 47 1/4"	74 29 1/4"	817.TR.02.24	706	59,00 130,09	0,146 5,15	5 5	
 <p>tavolo riunioni ovale su 2 gamboni in metallo</p> <p>oval conference table with 2 metal columns</p> <p>mesa de reuniones oval con 2 patas de metal</p> <p>table de réunion ovale sur 2 pieds en métal</p> <p>ovaler Besprechungstisch 250 cm auf 2 Metallsäulen</p> <p>mesa de reunião oval sobre 2 pedestais em metal</p>	250 98 1/2"	125 49 1/4"	74 29 1/4"	817.TR.04.25	724	59,00 130,09	0,161 5,68	5 5	

DV817 Oslo

M1	V01 piani worktops	WN	RC	NM				
	V02 gambe metallo metal legs	W	H	A	RO	VS	AP	GO
	V08 ABS	W	G1	A	RO	VS	AP	GO

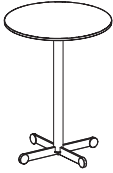
TAVOLI CAFFÈ COFFEE TABLES	L. W.	P. D.	H. H.	CODICE CODE	CATEGORIA PREZZO PRICE CATEGORY	Kg. lb	m³ ft³	n. no.
					M1			
 <p>Tavolino tondo da caffè</p> <p>Round coffee table</p> <p>Mesa de café redonda</p> <p>Table basse ronde</p> <p>runder Kaffeetisch</p> <p>Mesinha de café redondo</p>	80 31 1/2"	80 31 1/2"	45 17 3/4"	817.TT.04.08	328	15,50 34,17	0,041 1,44	3 3
 <p>Tavolo tondo H.107 cm</p> <p>Round table H.107 cm</p> <p>Mesa de café H.107 cm</p> <p>Table H.107 cm</p> <p>Rundtisch H. 107</p> <p>mesinha de café H.107 cm</p>	80 31 1/2"	80 31 1/2"	107 42 1/4"	817.TR.06.08	347	17,80 39,24	0,045 1,59	3 3

canale passacavi cable channel	H
-----------------------------------	---

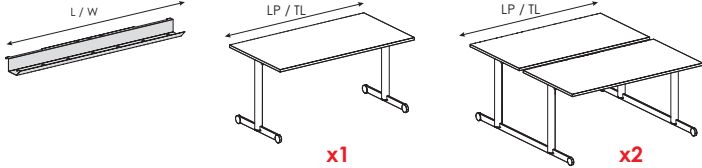
CANALIZZAZIONE WIRE MANAGEMENT	LP TL	L. W.	P. D.	H. H.	CODICE CODE	PREZZO PRICE	Kg. lb	m³ ft³	n. no.
 <p>Canale passacavi singolo per scrivanie e bench</p> <p>single cable channel for desks and benches</p> <p>canal pasacables individual para mesas y para</p> <p>goulotte simple pour bureaux et bench</p> <p>einzelner Kabelkanal für Schreibtische und Bench</p> <p>canal passa-cabos único para mesas e bench</p>	80 31 1/2"	55 21 3/4"	28,2 11 1/8"	6,5 2 5/8"	817.AP.01.08	37	1,30 2,86	0,010 0,35	1 1
	100 39 1/4"	55 21 3/4"	28,2 11 1/8"	6,5 2 5/8"	817.AP.01.10	37	1,30 2,86	0,010 0,35	1 1
	120 47 1/4"	95 37 1/2"	28,2 11 1/8"	6,5 2 5/8"	817.AP.01.12	54	2,00 4,41	0,016 0,56	1 1
	140 55"	95 37 1/2"	28,2 11 1/8"	6,5 2 5/8"	817.AP.01.14	54	2,00 4,41	0,016 0,56	1 1
	160 63"	135 53 1/4"	28,2 11 1/8"	6,5 2 5/8"	817.AP.01.16	68	2,80 6,17	0,025 0,88	1 1
	180 70 3/4"	135 53 1/4"	28,2 11 1/8"	6,5 2 5/8"	817.AP.01.18	68	2,80 6,17	0,025 0,88	1 1

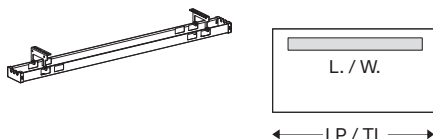
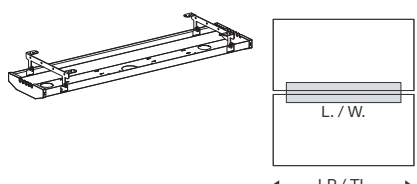
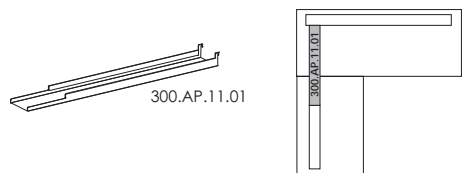
CANALIZZAZIONE WIRE MANAGEMENT	LP TL	L. W.	P. D.	H. H.	CODICE CODE	PREZZO PRICE	Kg. lb	m ³ ft ³	n. no.
 <p>canale passacavi singolo per tavoli single cable channel for desks canal pasacables individual para mesas goulotte simple pour bureaux einzelner Kabelkanal für Schreibtische canal passa-cabos único para mesas</p>	80 31 1/2"	60 23 5/8"	10,2 4 1/8"	11,4 4 1/2"	300.AP.25.06	48	0,90 1,98	0,003 0,10	1 1
	100 39 1/4"	80 31 1/2"	10,2 4 1/8"	11,4 4 1/2"	300.AP.25.08	50	1,50 3,30	0,004 0,14	1 1
	120 47 1/4"	100 39 3/8"	10,2 4 1/8"	11,4 4 1/2"	300.AP.25.10	54	1,90 4,18	0,006 0,21	1 1
	140 55"	120 47 1/4"	10,2 4 1/8"	11,4 4 1/2"	300.AP.25.12	57	2,00 4,41	0,007 0,24	1 1
	160 63"	140 55 1/8"	10,2 4 1/8"	11,4 4 1/2"	300.AP.25.14	61	2,20 4,85	0,009 0,31	1 1
	180 70 3/4"	160 63"	10,2 4 1/8"	11,4 4 1/2"	300.AP.25.16	64	2,50 5,51	0,010 0,35	1 1
 <p>canale passacavi doppio per tavoli a 2 scrivanie "bench" contrapposte double cable channel for desks "bench" composition canal pasacables doble para mesas "bench" enfrentadas goulotte double pour "bench" 2 bureaux v/v doppelter Kabelkanal für gegenüber angeordnete "Bench" Schreibtisch mit 2 gegenüber angeordneten Tischen canal passa-cabos duplo para mesas 2 escrivaninhas "bench" contrapostas</p>	140 55"	120 47 1/4"	28,2 11 1/8"	13 5 1/8"	300.AP.26.12	95	3,60 7,93	0,024 0,84	1 1
	160 63"	140 55 1/8"	28,2 11 1/8"	13 5 1/8"	300.AP.26.14	102	4,00 8,82	0,029 1,02	1 1
	180 70 3/4"	160 63"	28,2 11 1/8"	13 5 1/8"	300.AP.26.16	105	4,50 9,92	0,033 1,16	1 1
 <p>Prolunga da aggiungere ai canali passacavi utilizzati negli allunghi laterali per raccordo con il canale scrivania extension for the cable channels code used on the extension tables for the connection to the desk's cable channel Elemento de unión para integrar a los canales pasacables usados en los alargos laterales, para la unión con el canal de la mesa Rallonge à ajouter aux goulottes utilisées avec les extensions latérales pour unir à la goulotte du bureau Verlängerung für Kabelkanäle für seitliche Verlängerungen für Anschluss am Kabelkanal des Schreibtischs Extensão para complementar os canais passa-cabos, utilizados nas extensões laterais para interligações com canal escrivaninha</p>		78 30 3/4"	9,5 3 3/4"	4,5 1 7/8"	300.AP.11.01	25	1,30 2,86	0,005 0,17	1 1

CANALIZZAZIONE WIRE MANAGEMENT		CODICE CODE	PREZZO PRICE	Kg. lb	m ³ ft ³	n. no.
 <p>prolunga per canale passacavi singolo (confezione con 2 diverse misure)</p> <p>extension for single cable channel (kit of 2 different lengths)</p> <p>elemento de unión para el canal pasacable individual (bulto con 2 diferentes medidas)</p> <p>rallonge pour goulotte simple (colis de 2 dim. diverses)</p> <p>Verlängerung für einzelnen Kabelkanal (Packung mit 2 verschiedenen Maßen)</p> <p>extensão para canal passa-cabos único (embalagem com 2 medidas diversas)</p>	300.AP.03.01	35	0,60 1,32	0,001 0,03	1 1	
	 <p>prolunga per canale passacavi doppio</p> <p>extension for double cable channel</p> <p>elemento de unión para el canal pasacable doble</p> <p>rallonge pour goulotte double</p> <p>Verlängerung für doppelter Kabelkanal</p> <p>extensão para canal passa-cabos duplo</p>	300.AP.04.01	20	0,76 1,67	0,002 0,07	1 1

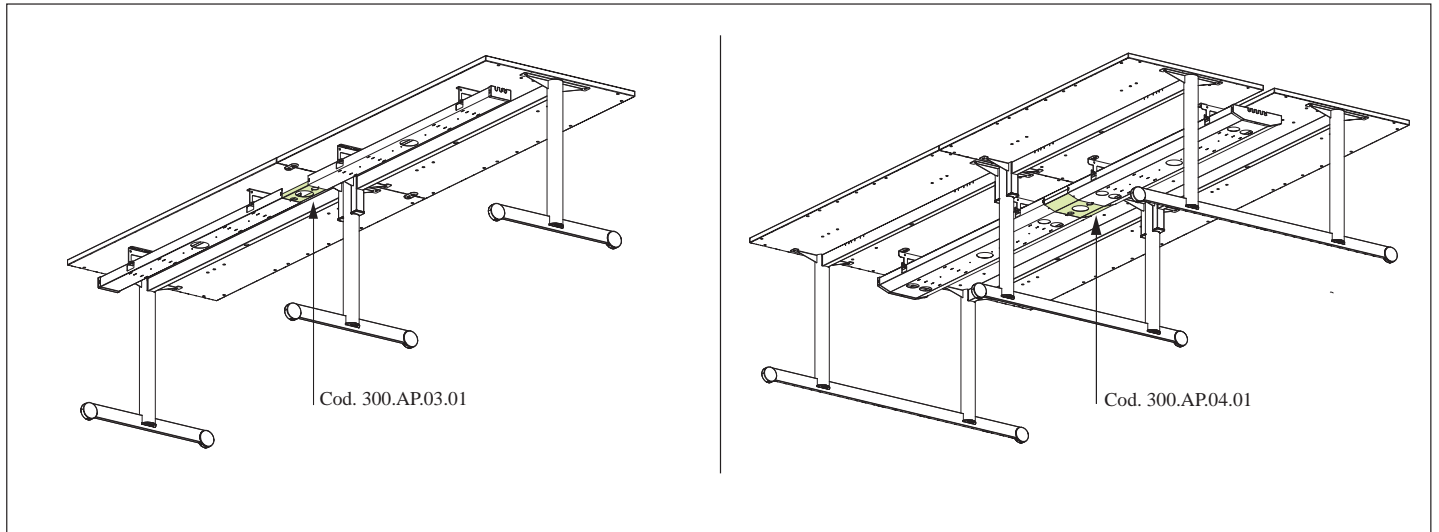

V02	canale cable	W	H	A	RO	VS	AP	GO
-----	-----------------	---	---	---	----	----	----	----

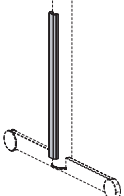
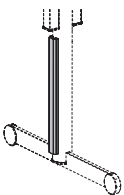
CANALIZZAZIONE WIRE MANAGEMENT		H. H.	CODICE CODE	V02	Kg. lb	m ³ ft ³	n. no.
 <p>Canale passacavi verticale per gamba terminale</p> <p>cable channel for terminal leg</p> <p>canal pasacables para pata terminal</p> <p>goulotte passe-cables pour pietement</p> <p>Kabelkanal für Tischbeine</p> <p>Canal passa-cabos para perna</p>	55 21 3/4"	817.AP.08.05	48	0,50 1,10	0,001 0,03	1 1	
	 <p>Canale passacavi verticale per gamba intermedia</p> <p>cable channel for middle leg</p> <p>canal pasacables para pata intermedia</p> <p>goulotte passe-cables pour pietement intermédiaire</p> <p>Kabelkanal für Tischbeine</p> <p>Canal passa-cabos para perna intermedia</p>	40 15 3/4"	817.AP.28.04	45	0,40 0,88	0,001 0,03	1 1

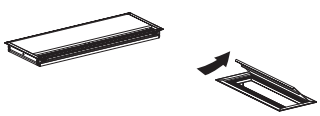

V13 top access top access	W	H	N
------------------------------	---	---	---

CANALIZZAZIONE WIRE MANAGEMENT	piano worktop	L. W.	P. D.	H. H.	CODICE CODE	V13	V13	Kg. lb	m ³ ft ³	n. no.		
 <p>top access in alluminio con sportello apribile</p> <p>top access aluminium coloured with opening door</p> <p>top access con tapa color aluminio</p> <p>top access avec clapet ouvrable couleur aluminium</p> <p>top Access mit Öffnungsklappe aluminiumfarbenem</p> <p>top access com portinhola cor alumínio</p>	25 mm 3/4"	32 12 5/8"	12,3 4 7/8"	2,4 1"	300.AC.38.02	53	145	0,36 0,79	0,005 0,17	1 1		
	<table border="1"> <tr> <td>Applicato</td> </tr> <tr> <td>Inserted Incorporado Appliqué Montiert Aplicado</td> </tr> </table>	Applicato	Inserted Incorporado Appliqué Montiert Aplicado									
Applicato												
Inserted Incorporado Appliqué Montiert Aplicado												

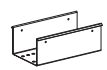
marsupio basket	H
--------------------	---

CANALIZZAZIONE WIRE MANAGEMENT	L. W.	P. D.	H. H.	CODICE CODE	PREZZO PRICE	Kg. lb	m ³ ft ³	n. no.
 <p>marsupio color alluminio per top access art. 300.AC.38.__</p> <p>basket (aluminium coloured) for top access art. 300.AC.38.__</p> <p>caja pasacables (color aluminio) para top access artículo 300.AC.38.__</p> <p>corbeille passe-câbles (couleur aluminium) pour top access art. 300.AC.38.__</p> <p>Warenkorb (Aluminium Farben) für top Access 300.AC.38.__</p> <p>cesta (cor aluminio) para top access art. 300.AC.38.__</p>	32 12 5/8"	10 4"	12 4 3/4"	300.AC.67.03	21	0,17 0,37	0,004 0,14	1 1

V13 top access top access	W	H	N
-------------------------------------	----------	----------	----------

CANALIZZAZIONE WIRE MANAGEMENT	L. W.	P. D.	H. H.	CODICE CODE	V13	V13	Kg. lb	m ³ ft ³	n. no.		
 <p>top access con sportello apribile su due lati top access with door opening on both sides top access con tapa que se puede abrir en los dos lados top access avec clapet ouvrable sur les deux cotés top Access mit Öffnungsklappe auf beiden Seiten top access com portinhola dos dois lados</p>	24,7 9 3/4"	17,5 7"	5 2"	300.AC.20.02	87	179	0,70 1,54	0,004 0,14	1 1		
	34,7 13 3/4"	17,5 7"	5 2"	300.AC.20.03	99	191	0,80 1,76	0,005 0,17	1 1		
	44,7 17 5/8"	17,5 7"	5 2"	300.AC.20.04	111	203	0,90 1,98	0,007 0,24	1 1		
						<table border="1"> <tr> <td>Applicato</td> </tr> <tr> <td>Inserted Incorporado Appliqué Montiert Aplicado</td> </tr> </table>	Applicato	Inserted Incorporado Appliqué Montiert Aplicado			
Applicato											
Inserted Incorporado Appliqué Montiert Aplicado											
 <p>top access+marsupio con sportello apribile su due lati top access+basket with door opening on both sides top access+caja pasacables con tapa que se puede abrir en los dos lados top access+corbeille passe-câbles avec clapet ouvrable sur les deux cotés top Access+Warenkorb mit Öffnungsklappe auf beiden Seiten top access+cesta com portinhola dos dois lados</p>	24,7 9 3/4"	17,5 7"	15 6"	300.AC.26.02	126	218	1,40 3,08	0,011 0,38	2 2		
	34,7 13 3/4"	17,5 7"	15 6"	300.AC.26.03	142	234	1,70 3,74	0,014 0,49	2 2		
	44,7 17 5/8"	17,5 7"	15 6"	300.AC.26.04	156	248	2,10 4,63	0,019 0,67	2 2		
						<table border="1"> <tr> <td>Applicato</td> </tr> <tr> <td>Inserted Incorporado Appliqué Montiert Aplicado</td> </tr> </table>	Applicato	Inserted Incorporado Appliqué Montiert Aplicado			
Applicato											
Inserted Incorporado Appliqué Montiert Aplicado											