

Toledo

DV818



LINEA OPERATIVA

OPERATIVE LINE

SERIE OPERATIVA

LIGNES OPÉRATIONNELLES

BÜROEINRICHTUNGSPROGRAMME

LINHA OPERATIVA

DV804
E-PLACE

DV801
ENTITY

DV812
ENNA

DV802
PAG

DV803
NOBU

DV818
TOLEDO

**con serratura**

with lock
con cerradura
avec serrure
mit Schloss
com fechadura

**articolo non in pronta consegna. Per la disponibilità contattare l'ufficio commerciale**

item not in prompt delivery. Please contact the commercial department for checking availability
producto no disponible en stock. Para la disponibilidad contactar con el departamento comercial
article non disponible en stock. Merci de contacter le service commercial pour vérifier la disponibilité
Dieses Produkt ist nicht sofort lieferbar. Setzen Sie sich mit unserem Handelsbüro in Verbindung für die Warenverfügbarkeit
produtos não pronta entrega. Acerca da disponibilidade, contactar o sector comercial

V01 M1 **Piani di lavoro in melaminico sp. 25 mm**
Melamine worktops 25 mm thick
Sobres de trabajo en melamina 25 mm de grosor
Plans de travail en mélaminé ép. 25 mm
Tischplatten aus Melamin St. 25 mm
Planos de trabalho em melamínico esp. 25 mm



Bianco
White
Blanco
Blanc
Weiss
Branco

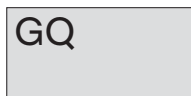

Grigio chiaro
Light grey
Gris claro
Gris clair
Hellgrau
Cinza claro



Rovere chiaro
Light oak
Roble claro
Chêne clair
Eiche hell
Carvalho claro



Noce "Maroncelli"
Walnut "Maroncelli"
Nogal "Maroncelli"
Noyer "Maroncelli"
Nussbaum "Maroncelli"
Nogueira "Maroncelli"



Terra d'ombra
Umber
Tierra sombra
Terre d'ombre
Umbr
Terra sombra

V01 M2 **NO**

Nero opaco
Matt black
Negro mate
Noir mat
Schwarz matt
Preto opaco

V02 **Strutture metalliche**
Metal structures
Estructuras metálicas
Structures métalliques
Metallstrukturen
Estruturas metálicas



Bianco
White
Blanco
Blanc
Weiß
Branco



Alluminio
Aluminium
Aluminio
Aluminium
Aluminium
Aluminio



Antracite
Anthracite
Antracita
Anthracite
Anthrazit
Antracite

V19 **Alimentazione elettrica**
Power supply
Alimentación eléctrica
Alimentation électrique
Stromversorgung
fonte de alimentação

EU

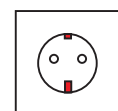

Presa per mercato EU
EU power outlet
Enchufe eléctrico EU
Prise électrique EU
Stecker für den EU-Markt
soquete eléctrico EU

UK

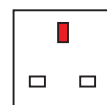

Presa per mercato UK
UK power outlet
Enchufe eléctrico UK
Prise électrique UK
Stecker für den UK-Markt
soquete eléctrico US

US

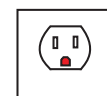

Presa per mercato US
US power outlet
Enchufe eléctrico US
Prise électrique US
Stecker für den UK-Markt
soquete eléctrico US

DV818 Toledo



Finiture - finishes - acabados - finitions - farben - acabamentos

V09 M1 Modesty panel sp.18 mm
 Modesty panel 18 mm thick
 Panel de protección en melamina 18 mm de grosor
 Voile de fond en melaminé ép. 18 mm
 Knieblende aus Melamin St. 18 mm
 Modesty panel en melaminico esp. 18 mm

WN	GQ	RC	NM	TD
Bianco White Blanco Blanc Weiss Branco	Grigio chiaro Light grey Gris claro Gris clair Hellgrau Cinza claro	Rovere chiaro Light oak Roble claro Chêne clair Eiche hell Carvalho claro	Noce "Maroncelli" Walnut "Maroncelli" Nogal "Maroncelli" Noyer "Maroncelli" Nussbaum "Maroncelli" Nogueira "Maroncelli"	Terra d'ombra Umber Tierra sombra Terre d'ombre Úmbra Terra sombra

V09 M2 NO
Nero opaco
 Matt black
 Negro mate
 Noir mat
 Schwarz matt
 Preto opaco

V13 Top access Alluminio
 Top access Aluminium
 Top access Aluminio
 Top access Aluminium
 Top Access Aluminium
 Top access Aluminio

		
W	H	N
Bianco White Blanco Blanc Weiss Branco	Alluminio Aluminium Aluminio Aluminium Aluminium Aluminio	Nero anodizzato Anodized black Negro anodizado Noir anodisé eloxiert Schwarz Preto anodizado

V04  **ORGATOWER - Scocche in melaminico sp. 18 mm**
 ORGATOWER - Melamine bodies 18 mm thick
 ORGATOWER - Cuerpos en melamina 18 mm de grosor
 ORGATOWER - Coffres en melaminé ép. 18 mm
 ORGATOWER - Korpus aus Melamin St. 18 mm
 ORGATOWER - Corpo en melaminico esp. 18 mm

WN	HH	AN
Bianco	Alluminio	Antracite
White Blanco Blanc Weiss Branco	Aluminium Aluminio Aluminium Aluminium Aluminio	Anthracite Antracita Anthracite Anthrazit Antracite

V01 M1  **ORGATOWER - Top in melaminico sp. 25 mm**
 ORGATOWER - Top 25 mm thick
 ORGATOWER - Encimeras en melamina 25 mm de grosor
 ORGATOWER - Tops en melaminé ép. 25 mm
 ORGATOWER - Abdeckplatte aus Melamin St. 25 mm
 ORGATOWER - Tamos en melaminico esp. 25 mm

WN**	GQ**	RC**	NM**	TD**
Bianco	Grigio chiaro	Rovere chiaro	Noce "Maroncelli"	Terra d'ombra
White Blanco Blanc Weiß Branco	Light grey Gris claro Gris clair Hellgrau Cinza claro	Light oak Roble claro Chêne clair Eiche hell Carvalho claro	Walnut "Maroncelli" Nogal "Maroncelli" Noyer "Maroncelli" Nussbaum "Maroncelli" Nogueira "Maroncelli"	Umber Tierra sombra Terre d'ombre Umbr Terra sombra

V01 M2  **NO****
 Nero opaco
 Black matt
 Negro mate
 Noir mat
 Schwarz matt
 Preto opaco

**** Top bordati in ABS perimetrale, COLORE IN TINTA CON I TOP**
 Tops with perimeter edge banding in ABS, WITH MATCHING TOP COLOUR
 Encimeras con cantos perimétricos en ABS, ACABADO COORDINADO A LAS ENCIMERAS
 Tops avec chants de périmètre en ABS, FINITION COORDONNEE AUX TOPS
 Abdeckplatte mit ABS Kante, PASSEND ZU DER ABDECKPLATTE FARBE
 Tamos orladas a ABS perimetral, A MESMA COR QUE A DAS TAMPOS

V23  **ORGATOWER - Maniglia per ante**
 ORGATOWER - Handle for doors
 ORGATOWER - Tirador para puerta
 ORGATOWER - Poignée pour porte
 ORGATOWER - Standardgriff für Türen
 ORGATOWER - Puxadores para portas

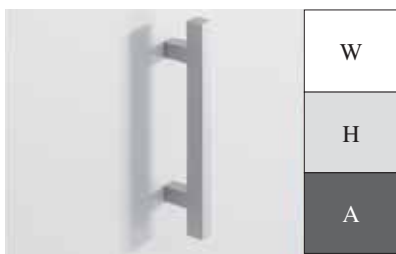

DV818 Toledo

Finiture - finishes - acabados - finitions - farben - acabamentos

V81

ORGATOWER - Anta singola : maniglia lato SINISTRO (SX) o lato DESTRO (DX)

ORGATOWER - Single door : handle LEFT hand (SX) or RIGHT hand (DX)
 ORGATOWER - Puerta : tirador lado izq (SX) o lado drch (DX)
 ORGATOWER - Porte : poignée côté GAUCHE (SX) ou côté DROITE (DX)
 ORGATOWER - Tür : griff LINKS (SX) oder RECHT (DX)
 ORGATOWER - Porta : puxadored lateral ISQUIERDA (SX) ou lateral DIREITO (DX)

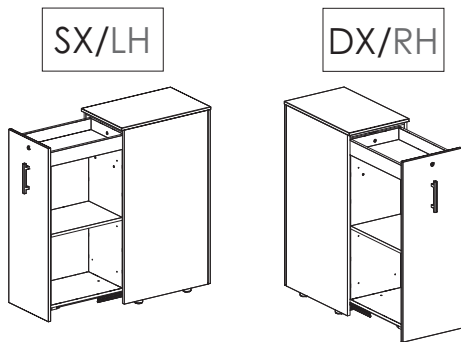

V05
M1

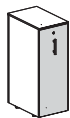

ORGATOWER - Frontali in melaminico sp. 18 mm

ORGATOWER - Melamine drawers 18 mm thick
 ORGATOWER - Frontales en melamina 18 mm de grosor
 ORGATOWER - Frontale en melaminé ép. 18 mm
 ORGATOWER - Türen aus Melamin St. 18 mm
 ORGATOWER - Frontal en melaminico esp. 18 mm

WN**

Bianco
 White
 Blanco
 Blanc
 Weiß
 Branco

GQ**

Grigio chiaro
 Light grey
 Gris claro
 Gris clair
 Hellgrau
 Cinza claro

RC**

Rovere chiaro
 Light oak
 Roble claro
 Chêne clair
 Eiche hell
 Carvalho claro

NM**

Noce "Maroncelli"
 Walnut "Maroncelli"
 Nogal "Maroncelli"
 Noyer "Maroncelli"
 Nussbaum "Maroncelli"
 Nogueira "Maroncelli"

TD**

Terra d'ombra
 Umber
 Tierra sombra
 Terre d'ombre
 Umbra
 Terra sombra

AT*

Azzurro turchese
 Turquoise blue
 Azul turquesa
 Bleu turquoise
 Türkisblau
 Azul turquesa

GS*

Giallo senape
 Mustard yellow
 Amarillo mostaz
 Jaune moutarde
 Senfgelb
 Amarela mostarda

RP*

Rosso papavero
 Poppy red
 Rojo amapola
 Rouge coquelicot
 Mohnrot
 Vermelho papoula

VB*

Verde bambù
 Bamboo green
 Verde bambù
 Vert bambou
 Bambusgrün
 Verde bambù

V05
M2

NO**

Nero opaco
 Black matt
 Negro mate
 Noir mat
 Schwarz matt
 Preto opaco

* Frontali bordati in ABS perimetrale, colore ALLUMINIO (H)

Drawers with perimeter edge banding in ABS, ALUMINIUM colour (H)
 Frontales con cantos perimétricos en ABS, color ALUMINIO (H)
 Frontales avec chants de périmètre en ABS, couleur ALUMINIUM (H)
 Türen mit ABS Kante, ALUMINIUM (H) Farbe
 Frontales orladas a ABS perimetral, cor ALUMÍNIO (H)

** Frontali bordati in ABS perimetrale, colore IN TINTA CON LE ANTE

Drawers with perimeter edge banding in ABS, WITH MATCHING DOOR COLOUR
 Frontales con cantos perimétricos en ABS, ACABADO COORDINADO A LAS PUERTAS
 Frontales avec chants de périmètre en ABS, FINITION COORDONNEE AUX PORTES
 Türen mit ABS Kante, PASSEND ZU DER TÜR FARBE
 Frontales orladas a ABS perimetral, À MESMA COR QUE A DAS PORTAS

V06

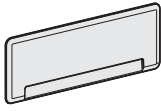

Frontal panels in tessuto acustici - Rivestimento in poliester

Acoustic fabric frontal panels - Polyester coating
 Paneles frontales acústico en tejido - Revestimiento en polyester
 Panneaux écran acoustique en tissu - Revêtement en polyéster
 Akustische Sichtblende mit Stoffueberzug aus Stoff - Beistellschrank aus polyester
 Frontal panels acústico em tecido - Revestimento em polyéster



JB9109

JB9109 - Pepe

JB9109 - Pepper
 JB9109 - Pimienta
 JB9109 - Poivre
 JB9109 - Pfeffer
 JB9109 - Pimenta

JB9110

JB9110 - Sesamo

JB9110 - Sesame
 JB9110 - Sésamo
 JB9110 - Sésame
 JB9110 - Sesam
 JB9110 - Sésamo

JB9804

JB9804 - Timo

JB9804 - Thyme
 JB9804 - Tomillo
 JB9804 - Thym
 JB9804 - Thymian
 JB9804 - Tomilho

JB9806

JB9806 - Liquirizia

JB9806 - Licorice
 JB9806 - Regaliz
 JB9806 - Réglisse
 JB9806 - Lakritze
 JB9806 - Alcaçuz



Trevira CS Bioactive

Rivestimento non in pronta consegna. Per la disponibilità contattare l'ufficio commerciale.

Coating not in prompt delivery. Please contact the commercial department for checking the availability.
 Revestimiento no disponible en stock. Para la disponibilidad contactar con el departamento comercial.
 Revêtement non disponible en stock. Merci de contacter le service commercial pour vérifier la disponibilité.
 Dieses Überzug ist nicht sofort lieferbar. Setzen Sie sich mit unserem Handelsbüro in Verbindung für die Warenverfügbarkeit.
 Revestimento não pronta entrega. Acerca da disponibilidade, contactar o sector comercial.

Quantità minima per dimensione e colore : 30 pz

Minimum quantity per dimension and color: 30 pcs
 Quantité minimum par dimension et couleur: 30 pièces
 Cantidad mínima por talla y color: 30 piezas
 Mindestbestellmenge: 30 Stk pro Farbe und Abmessung.
 Quantidade mínima por tamanho e cor : 30 peças

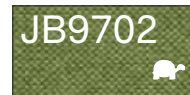
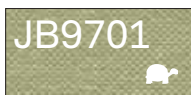
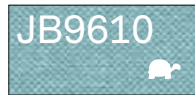
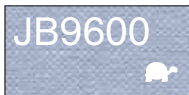
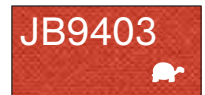
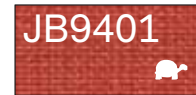
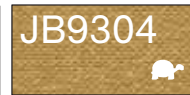
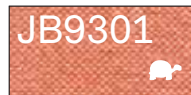
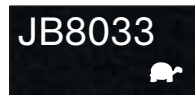
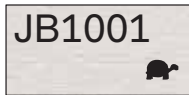

Morsetti realizzati in nylon stampato colore bianco (W), antracite (A) o grigio (G)

Clamps made of moulded nylon painted in white (W), anthracite (A) or grey (G) colour
 Abrazaderas realizados en nylon moldeado color blanco (W), antracita (A) o gris (G)
 Structures métalliques - Réalisés en nylon moulé couleur blanc (W), anthracite (A) ou gris (G)
 Klemmen gefertigt aus geprägtem nylon in Farbe Weiß (W), Anthrazit (A) oder Grau (G)
 Grampos realizados em nylon moldado na cor branco (W), antracite (A) ou cinza (G)

W	A	G	
Bianco	Antracite	Grigio	
White	Anthracite	Grey	
Blanco	Antracita	Gris	
Blanc	Anthracite	Gris	
Weiss	Anthrazit	Grau	
Branco	Antracite	Cinza	

DV818 Toledo

Finiture - finishes - acabados - finitions - farben - acabamentos

V06

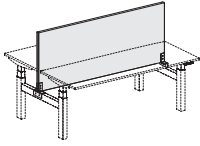

Frontal panel in melaminico rivestito in tessuto per bench (NON ACUSTICO)

Fabric-covered melamine frontal panel for bench (NOT ACOUSTIC)
 Panel frontal de melamina revestido en tejido para bench (NO ACÚSTICO)
 Panneau écran en mélamine revêtu en tissu pour tables avec deux bureaux vis-à-vis (NO ACOUSTIQUE)
 Sichtblende mit Stoffueberzug aus Stoff - Beistellschrank aus polyester (KEINE AKUSTISCHE)
 Frontal panels em melamina revestido tecido - Revestimento em polyéster (NO ACÚSTICO)



JB9109

JB9110

JB9804

JB9806

JB9109 - Pepe

JB9110 - Sesamo

JB9804 - Timo

JB9806 - Liquirizia

JB9109 - Pepper
 JB9109 - Pimienta
 JB9109 - Poivre
 JB9109 - Pfeffer
 JB9109 - Pimenta

JB9110 - Sesame
 JB9110 - Sésamo
 JB9110 - Sésame
 JB9110 - Sesam
 JB9110 - Sésamo

JB9804 - Thyme
 JB9804 - Tomillo
 JB9804 - Thym
 JB9804 - Thymian
 JB9804 - Tomilho

JB9806 - Licorice
 JB9806 - Regaliz
 JB9806 - Régλισse
 JB9806 - Lakritze
 JB9806 - Alcaçuz



Trevira CS Bioactive

Rivestimento non in pronta consegna. Per la disponibilità contattare l'ufficio commerciale.

Coating not in prompt delivery. Please contact the commercial department for checking the availability.
 Revestimiento no disponible en stock. Para la disponibilidad contactar con el departamento comercial.
 Revêtement non disponible en stock. Merci de contacter le service commercial pour vérifier la disponibilité.
 Dieses Überzug ist nicht sofort lieferbar. Setzen Sie sich mit unserem Handelsbüro in Verbindung für die Warenverfügbarkeit.
 Revestimento não pronta entrega. Acerca da disponibilidade, contactar o sector comercial.

Quantità minima per dimensione e colore : 30 pz

Minimum quantity per dimension and color: 30 pcs
 Quantité minimum par dimension et couleur: 30 pièces
 Cantidad mínima por talla y color: 30 piezas
 Mindestbestellmenge: 30 Stk pro Farbe und Abmessung.
 Quantidade mínima por tamanho e cor : 30 peças

JB1001

JB8033

JB9301

JB9304

JB9401

JB9403

JB9600

JB9610

JB9701

JB9702

JB9805

DV818 Toledo

M1	V01 piani worktops	WN	GQ	RC	NM	TD
	V02 gambe legs	W	H	A		

M2	V01 piani worktops	NO		
	V02 gambe legs	W	H	A

V19 alimentazione power supply	EU	UK	US
--------------------------------	----	----	----

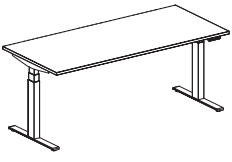
SCRIVANIA DESKS	L. W.	P. D.	H. H.	CODICE CODE	M1			M2			Kg. lb	m ³ ft ³	n. no.
					EU	UK	US	EU	UK	US			
 <p>Scrivania regolabile in altezza desk with electric height adjustment mesa ajustables en altura table de bureau avec réglage en hauteur Schreibtische mit Höheneinstellung mesa escritivaninha com regulagem de altura</p>	140 55 1/8"	65 25 5/8"	64,5÷130 25 1/2"-51 1/4"	818.TS.57.14	1.017	1.017	1.032	1.113	1.113	1.128	48,50 106,94	0,090 3,18	4 4
	160 63"	65 25 5/8"	64,5÷130 25 1/2"-51 1/4"	818.TS.57.16	1.035	1.035	1.050	1.123	1.123	1.138	51,70 113,99	0,096 3,39	4 4
	180 70 7/8"	65 25 5/8"	64,5÷130 25 1/2"-51 1/4"	818.TS.57.18	1.078	1.078	1.093	1.170	1.170	1.185	53,40 117,74	0,102 3,60	4 4
	140 55 1/8"	80 31 1/2"	64,5÷130 25 1/2"-51 1/4"	818.TS.58.14	1.025	1.025	1.040	1.128	1.128	1.143	54,00 119,07	0,101 3,56	4 4
	160 63"	80 31 1/2"	64,5÷130 25 1/2"-51 1/4"	818.TS.58.16	1.040	1.040	1.055	1.135	1.135	1.150	55,60 122,59	0,108 3,81	4 4
	180 70 7/8"	80 31 1/2"	64,5÷130 25 1/2"-51 1/4"	818.TS.58.18	1.092	1.092	1.107	1.183	1.183	1.198	60,00 132,30	0,115 4,06	4 4

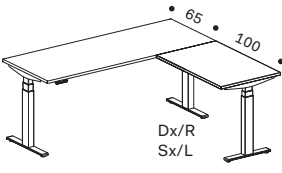
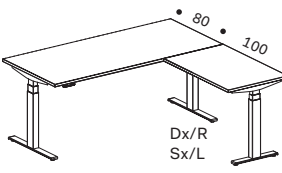
COMPOSIZIONI SCRIVANIA CON DATTELO DESK WITH LATERAL SIDE COMPOSITIONS	L. W.	P. D.	H. H.	CODICE CODE	M1			M2			Kg. lb	m ³ ft ³	n. no.
					EU	UK	US	EU	UK	US			
 <p>Scrivania P.65 cm con 1 dattilo laterale (Dx/Sx) D.65 desk with return (LH/RH) Mesa P.65 cm con 1 alargo lateral (Drh/Izq) Bureau P. 65 cm avec retour (D/G) Tisch T.65 cm mit 1 Seitenverbindungstisch (R/L) Mesa P.65 cm com 1 extensão lateral (Dx/Sx)</p>	140 55 1/8"	165 65"	64,5÷130 25 1/2"-51 1/4"	818.TD.50.14	1.661	1.661	1.676	1.807	1.807	1.822	80,20 176,84	0,166 5,86	8 8
	160 63"	165 65"	64,5÷130 25 1/2"-51 1/4"	818.TD.50.16	1.679	1.679	1.694	1.817	1.817	1.832	83,40 183,89	0,172 6,07	8 8
	180 70 7/8"	165 65"	64,5÷130 25 1/2"-51 1/4"	818.TD.50.18	1.722	1.722	1.737	1.864	1.864	1.879	85,10 187,64	0,178 6,28	8 8
 <p>Scrivania P.80 cm con 1 dattilo laterale (Dx/Sx) D.80 desk with return (LH/RH) Mesa P.80 cm con 1 alargo lateral (Drh/Izq) Bureau P. 80 cm avec retour (D/G) Tisch T.80 cm mit 1 Seitenverbindungstisch (R/L) Mesa P.80 cm com 1 extensão lateral (dir./esq.)</p>	140 55 1/8"	180 70 7/8"	64,5÷130 25 1/2"-51 1/4"	818.TD.51.14	1.669	1.669	1.684	1.822	1.822	1.837	85,70 188,96	0,177 6,25	8 8
	160 63"	180 70 7/8"	64,5÷130 25 1/2"-51 1/4"	818.TD.51.16	1.684	1.684	1.699	1.829	1.829	1.844	87,30 192,49	0,184 6,50	8 8
	180 70 7/8"	180 70 7/8"	64,5÷130 25 1/2"-51 1/4"	818.TD.51.18	1.736	1.736	1.751	1.877	1.877	1.892	91,70 202,19	0,191 6,74	8 8

DV818 Toledo

M1	V01 piani worktops	WN	GQ	RC	NM	TD
	V02 gambe legs	W	H	A		

M2	V01 piani worktops	NO		
	V02 gambe legs	W	H	A

V19 alimentazione power supply	EU	UK	US
--------------------------------	----	----	----

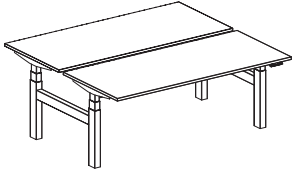
TAVOLI BENCH BENCH DESKS	L. W.	P. D.	H. H.	CODICE CODE	M1			M2			Kg. lb	m³ ft³	n. no.	
					EU	UK	US	EU	UK	US				
 <p>Bench regolabile elettricamente</p> <p>2 desk "bench" composition with electric height adjustment</p> <p>2 mesas "bench" enfrentadas</p> <p>2 "bench" bureaux v/v</p> <p>"Bench" Schreibtisch mit 2 gegenüber angeordneten Tischen</p> <p>mesa 2 escritaninhas "bench" contrapostas</p>	140 55 1/8"	136,5 53 3/4"	61,5÷127,5 24 1/4"-49 1/4"	818.TB.32.14	2.219	2.219	2.249	2.411	2.411	2.441	92,60 204,18	0,183 6,46	7 7	
	160 63"	136,5 53 3/4"	61,5÷127,5 24 1/4"-49 1/4"	818.TB.32.16	2.255	2.255	2.285	2.431	2.431	2.461	99,00 218,29	0,195 6,89	7 7	
	180 70 7/8"	136,5 53 3/4"	61,5÷127,5 24 1/4"-49 1/4"	818.TB.32.18	2.341	2.341	2.371	2.525	2.525	2.555	102,40 225,79	0,207 7,31	7 7	
	140 55 1/8"	166,5 65 5/8"	61,5÷127,5 24 1/4"-49 1/4"	818.TB.33.14	2.234	2.234	2.264	2.440	2.440	2.470	101,80 224,46	0,204 7,20	7 7	
	160 63"	166,5 65 5/8"	61,5÷127,5 24 1/4"-49 1/4"	818.TB.33.16	2.264	2.264	2.294	2.454	2.454	2.484	105,00 231,52	0,218 7,70	7 7	
	180 70 7/8"	166,5 65 5/8"	61,5÷127,5 24 1/4"-49 1/4"	818.TB.33.18	2.368	2.368	2.398	2.550	2.550	2.580	113,80 250,92	0,232 8,19	7 7	

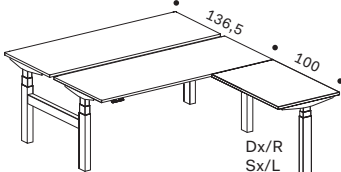
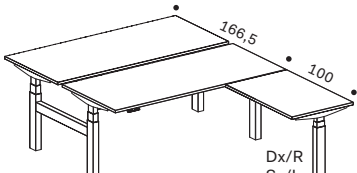



COMPOSIZIONI BENCH CON ALLUNGO BENCH WITH LATERAL SIDE COMPOSITIONS	L. W.	P. D.	H. H.	CODICE CODE	M1			M2			Kg. lb	m³ ft³	n. no.
					EU	UK	US	EU	UK	US			
 <p>Bench P.136,5 cm con 1 dattilo laterale (Dx/Sx)</p> <p>Bench desk D.136,5 cm with 1 lateral extension (R/L)</p> <p>Bench P.136,5 cm con 1 alargamento lateral (Drh/lzq)</p> <p>Bench P. 136,5 avec 1 retour (D/G)</p> <p>"Bench" Schreibtisch T.136,5 cm mit 1 Seitenverbindungstisch (R/L)</p> <p>2 mesas com escritaninhas contrapostas P.136,5 cm com 1 extensão lateral (dir./esq.)</p>	140 55 1/8"	236,5 93 1/8"	61,5÷127,5 24 1/4"-49 1/4"	818.TD.52.14	2.795	2.795	2.825	3.037	3.037	3.067	122,10 269,23	0,257 9,08	10 10
	160 63"	236,5 93 1/8"	61,5÷127,5 24 1/4"-49 1/4"	818.TD.52.16	2.831	2.831	2.861	3.057	3.057	3.087	128,50 283,34	0,269 9,50	10 10
	180 70 7/8"	236,5 93 1/8"	61,5÷127,5 24 1/4"-49 1/4"	818.TD.52.18	2.917	2.917	2.947	3.151	3.151	3.181	131,90 290,83	0,281 9,92	10 10
 <p>Bench P.166,5 cm con 1 dattilo laterale (Dx/Sx)</p> <p>Bench desk D.166,5 cm with 1 lateral extension (R/L)</p> <p>Bench P.166,5 cm con 1 alargamento lateral (Drh/lzq)</p> <p>Bench P. 166,5 avec 1 retour (D/G)</p> <p>"Bench" Schreibtisch T.166,5 cm mit 1 Seitenverbindungstisch (R/L)</p> <p>2 mesas com escritaninhas contrapostas P.166,5 cm com 1 extensão lateral (dir./esq.)</p>	140 55 1/8"	266,5 105"	61,5÷127,5 24 1/4"-49 1/4"	818.TD.53.14	2.810	2.810	2.840	3.066	3.066	3.096	131,30 289,51	0,278 9,82	10 10
	160 63"	266,5 105"	61,5÷127,5 24 1/4"-49 1/4"	818.TD.53.16	2.840	2.840	2.870	3.080	3.080	3.110	134,50 296,57	0,292 10,31	10 10
	180 70 7/8"	266,5 105"	61,5÷127,5 24 1/4"-49 1/4"	818.TD.53.18	2.944	2.944	2.974	3.176	3.176	3.206	143,30 315,97	0,306 10,81	10 10

DV818 Toledo

M1	V01 piani worktops	WN	GQ	RC	NM	TD
	V02 gambe legs	W	H	A		

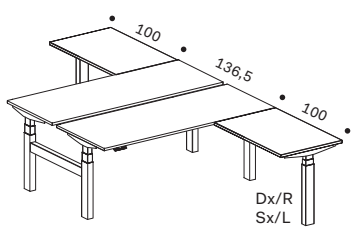
M2	V01 piani worktops	NO		
	V02 gambe legs	W	H	A

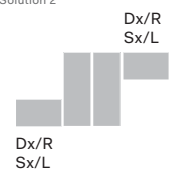
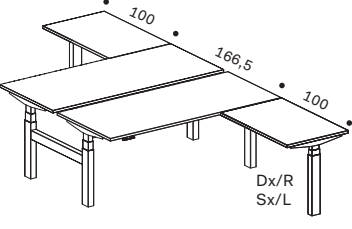
V19 alimentazione power supply	EU	UK	US
--------------------------------	----	----	----

COMPOSIZIONI BENCH CON ALLUNGO BENCH WITH LATERAL SIDE COMPOSITIONS	L. W.	P. D.	H. H.	CODICE CODE	M1			M2			Kg. lb	m ³ ft ³	n. no.
					EU	UK	US	EU	UK	US			
 <p>Soluzione 1 Solution 1</p>  <p>Soluzione 2 Solution 2</p>  <p>Bench P.136,5 cm con 2 dattilo laterali (Dx/Sx)</p> <p>Bench desk D.136,5 cm with 2 lateral extensions (R/L)</p> <p>Bench P.136,5 cm con 2 alargos lateral (Drh/Izq)</p> <p>Bench P. 136,5 avec 2 retours (D/G)</p> <p>“Bench” Schreibtisch T.136,5 cm mit 2 Seitenverbindungstischen (R/L)</p> <p>2 mesas com escrivaninhas contrapostas P.136,5 cm com 2 extensão laterales (dir./esq.)</p>	140 55 1/8"	336,5 132 1/2"	61,5±127,5 24 1/4"-49 1/4"	818.TD.54.14	3.371	3.371	3.401	3.663	3.663	3.693	151,60 334,27	0,331 11,69	13 13
	160 63"	336,5 132 1/2"	61,5±127,5 24 1/4"-49 1/4"	818.TD.54.16	3.407	3.407	3.437	3.683	3.683	3.713	158,00 348,39	0,343 12,12	13 13
	180 70 7/8"	336,5 132 1/2"	61,5±127,5 24 1/4"-49 1/4"	818.TD.54.18	3.493	3.493	3.523	3.777	3.777	3.807	161,40 355,88	0,355 12,54	13 13
 <p>Soluzione 1 Solution 1</p>  <p>Soluzione 2 Solution 2</p>  <p>Bench P.166,5 cm con 2 dattilo laterali (Dx/Sx)</p> <p>Bench desk D.166,5 cm with 2 lateral extensions (R/L)</p> <p>Bench P.166,5 cm con 2 alargos lateral (Drh/Izq)</p> <p>Bench P. 166,5 avec 2 retours (D/G)</p> <p>“Bench” Schreibtisch T.166,5 cm mit 2 Seitenverbindungstischen (R/L)</p> <p>2 mesas com escrivaninhas contrapostas P.166,5 cm com 2 extensão laterales (dir./esq.)</p>	140 55 1/8"	366,5 144 3/8"	61,5±127,5 24 1/4"-49 1/4"	818.TD.55.14	3.386	3.386	3.416	3.692	3.692	3.722	160,80 354,56	0,352 12,43	13 13
	160 63"	366,5 144 3/8"	61,5±127,5 24 1/4"-49 1/4"	818.TD.55.16	3.416	3.416	3.446	3.706	3.706	3.736	164,00 361,62	0,366 12,93	13 13
	180 70 7/8"	366,5 144 3/8"	61,5±127,5 24 1/4"-49 1/4"	818.TD.55.18	3.520	3.520	3.550	3.802	3.802	3.832	172,80 381,02	0,380 13,42	13 13

DV804 E-PLACE
DV801 ENTITY
DV812 ENNA
DV802 PAG
DV803 NOBU
DV818 TOLEDO

V04 kit unione connection kit	W	H	N
----------------------------------	---	---	---

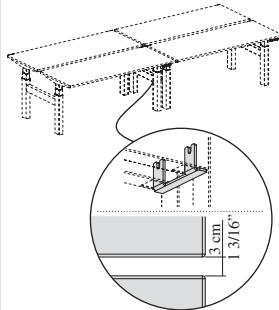
ACCESSORI PER TAVOLI BENCH ACCESSORIES FOR BENCH TABLES	CODICE CODE	V04	Kg. lb	m ³ ft ³	n. no.
 <p>Kit unione bench in linea</p> <p>Side linking unit for bench</p> <p>Placa de union bench en linea</p> <p>Ecarteur pour bureau bench</p> <p>Bausatz für die Verbindung der Verlängerungen "Bench" Tischen</p> <p>Placa de junta para Bench em linea</p>	818.KT.03.00	35	0,50 1,10	0,001 0,03	1 1

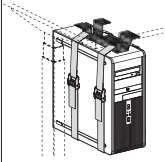
ACCESSORI ACCESSORIES	CODICE CODE	PREZZO PRICE	Kg. lb	m ³ ft ³	n. no.
 <p>porta CPU sospeso</p> <p>hanging CPU holder</p> <p>porta CPU colgante</p> <p>porte unité centrale suspendu</p> <p>Tower-Ablage zum Hängen für Tische</p> <p>porta CPU suspenso</p>	818.AC.01.00	106	1,20 2,64	0,004 0,14	1 1

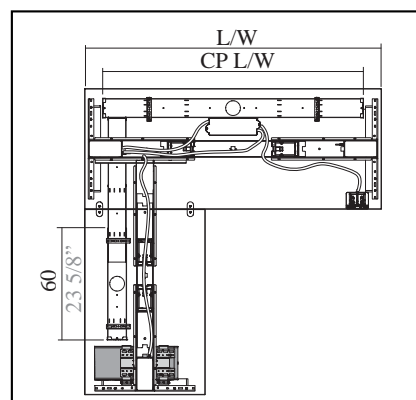
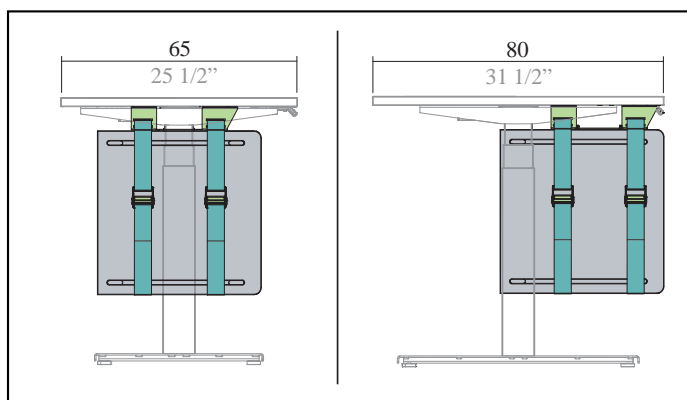

V13 top access top access	W	H	N
------------------------------	---	---	---

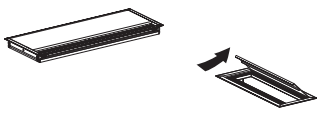
CANALIZZAZIONE WIRE MANAGEMENT	piano worktop	L. W.	P. D.	H. H.	CODICE CODE	V13	V13	Kg. lb	m ³ ft ³	n. no.		
 <p>top access in alluminio con sportello apribile</p> <p>top access aluminium coloured with opening door</p> <p>top access con tapa color aluminio</p> <p>top access avec clapet ouvrable couleur aluminium</p> <p>top Access mit Öffnungsklappe aluminiumfarbenem</p> <p>top access com portinhola cor alumínio</p>	18-25 mm 3/4"	32 12 5/8"	12,3 4 7/8"	2,4 1"	300.AC.38.02	53	145	0,36 0,79	0,005 0,17	1 1		
	<table border="1"> <tr> <td>Applicato</td> </tr> <tr> <td>Insered Incorporado Appliqué Montiert Aplicado</td> </tr> </table>		Applicato	Insered Incorporado Appliqué Montiert Aplicado								
Applicato												
Insered Incorporado Appliqué Montiert Aplicado												

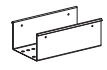

marsupio basket	H
--------------------	---

CANALIZZAZIONE WIRE MANAGEMENT	L. W.	P. D.	H. H.	CODICE CODE	PREZZO PRICE	Kg. lb	m ³ ft ³	n. no.
 <p>marsupio color alluminio per top access art. 300.AC.38.__</p> <p>basket (aluminium coloured) for top access art. 300.AC.38.__</p> <p>caja pasacables (color aluminio) para top access artículo 300.AC.38.__</p> <p>corbeille passe-câbles (couleur aluminium) pour top access art. 300.AC.38.__</p> <p>Warenkorb (Aluminium Farben) für top Access 300.AC.38.__</p> <p>cesta (cor aluminio) para top access art. 300.AC.38.__</p>	32 12 5/8"	10 4"	12 4 3/4"	300.AC.67.03	21	0,17 0,37	0,004 0,14	1 1

CANALIZZAZIONE WIRE MANAGEMENT	L. W.	P. D.	H. H.	CODICE CODE	PREZZO PRICE	Kg. lb	m ³ ft ³	n. no.
 <p>canale passacavi attrezzabile</p> <p>equippable wire management</p> <p>canal pasacables equipable</p> <p>goulotte passe-câbles à accessoriser</p> <p>Kabelkanal</p> <p>canal passa-cabos</p>	115 45 3/8"	12 4 3/4"	2 7/8"	300.CL.01.40	24	1,50 3,30	0,003 0,10	1 1

catena passacavi
cable channel chain

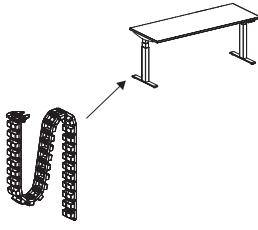
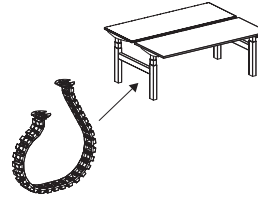
NO

ACCESSORI PER SCRIVANIE REGOLABILI IN ALTEZZA ACCESSORIES FOR DESK WITH HEIGHT ADJUSTMENT		H. H.	CODICE CODE	PREZZO PRICE	Kg. lb	m ³ ft ³	n. no.
 <p>Vertebra passacavi per scrivania con regolazione elettrica in altezza</p> <p>Cable management chain for desks with electric height adjustment</p> <p>Cadena de gestión de cables para mesas con ajuste de altura eléctrico</p> <p>Chaîne de gestion des câbles pour bureaux avec réglage hauteur électrique</p> <p>Kabelführungskette für Tische mit elektrischer Höheneinstellung</p> <p>Cadeia de gerenciamento de cabos para mesas com regulação eléctrica em altura</p>	132 52"	818.AP.10.13	74	1,00 2,20	0,004 0,14	1 1	
 <p>Vertebra passacavi per tavolo a 2 scrivanie bench con regolazione elettrica in altezza</p> <p>Cable management chain for bench desks with electric height adjustment</p> <p>Cadena de gestión de cables para "bench" enfrontadas con ajuste de altura eléctrico</p> <p>Chaîne de gestion des câbles pour bench bureaux v/v avec réglage hauteur électrique</p> <p>Kabelführungskette für „Bench“ Schreibtisch mit elektrischer Höheneinstellung</p> <p>Cadeia de gerenciamento de cabos para escrivaninhas "bench" contrapostas com regulação eléctrica em altura</p>	94 37 1/8"	818.AP.10.09	45	1,00 2,20	0,004 0,14	1 1	
 <p>passacavi verticale a spirale</p> <p>Vertical spiral cable duct</p> <p>pasacables vertical en espiral</p> <p>passé-câbles vertical à spirales</p> <p>senkrechte, spiralförmige Kabelführung</p> <p>passa-cabos vertical em espiral</p>		300.AP.V1.00	53	0,84 1,85	0,004 0,14	1 1	
		passacavi a spirale spiral cable duct	W	H	A		

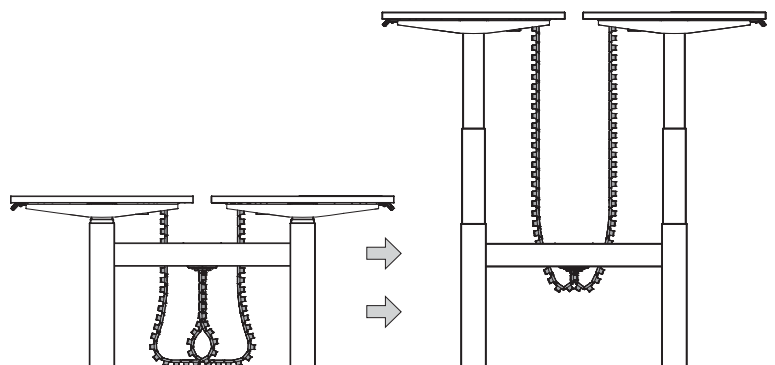
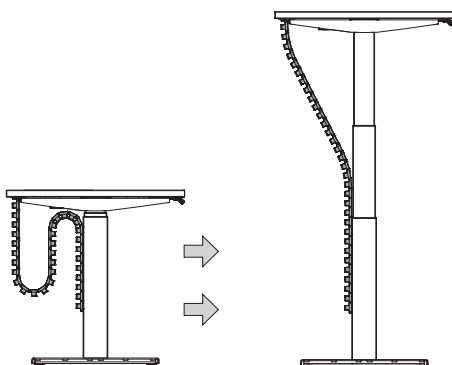
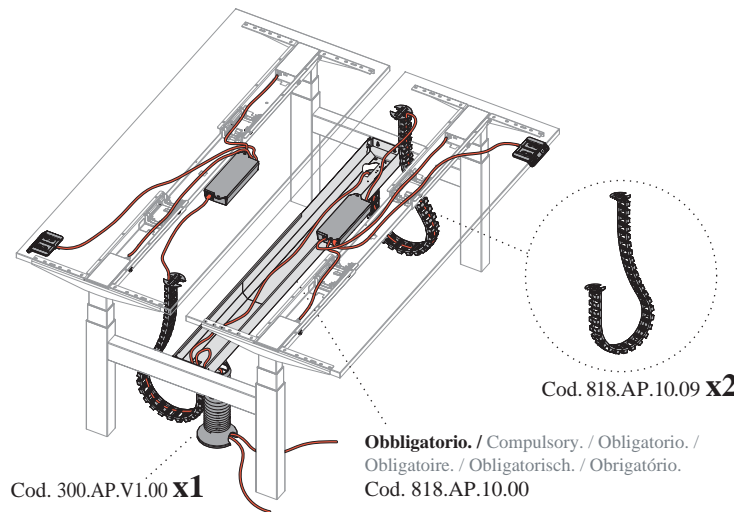
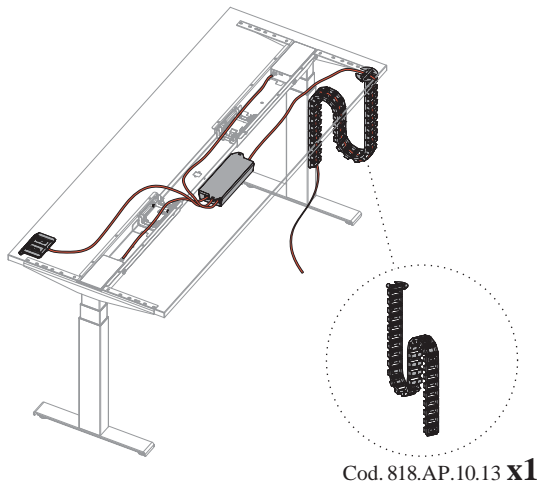

V02 canale cable channel	W	H	A
-----------------------------	---	---	---

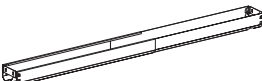
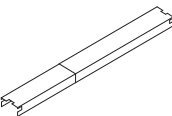
CANALIZZAZIONE WIRE MANAGEMENT		L. W.	CODICE CODE	V02	Kg. lb	m ³ ft ³	n. no.
 <p>Canalizzazione telescopica in lamiera per tavoli bench L.140,160,180 cm Telescopic wire management in metal sheet for bench desks L.140,160,180 cm Canalización telescópico en chapa para bench Goulottes télescopique métalliques Ausziehbarer Kabelkanal aus blech Canalizaçãõ telescópica em chapa</p>	140-160-180 55"-63"-70 3/4"	818.AP.10.00	97	5,40 11,90	0,022 0,77	1 1	
 <p>Carter di copertura telescopico per canalina bench Telescopic bench cable-channel cover casing Carter de cobertura telescópico para canal pasacables bench Carter de couverture telescopique pour goulotte bench Abdeckleiste ausziehbarer für Bench-Kabelkanal Carter de cobertura telescópico para fiação de mesa Bench</p>	140-160-180 55"-63"-70 3/4"	818.AP.43.00	82	4,20 9,26	0,022 0,77	1 1	

canale cable channel	H
-------------------------	---

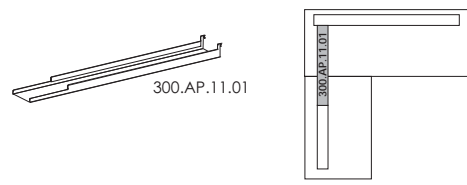
CANALIZZAZIONE WIRE MANAGEMENT		LP TL	L. W.	P. D.	H. H.	CODICE CODE	PREZZO PRICE	Kg. lb	m ³ ft ³	n. no.
 <p>canale passacavi singolo per tavoli single cable channel for desks canal pasacables individual para mesas goulotte simple pour bureaux einzelner Kabelkanal für Schreibtische canal passa-cabos único para mesas</p>	100 39 1/4"	40 15 3/4"	10,2 4 1/8"	11,4 4 1/2"	300.AP.25.04	42	0,80 1,76	0,002 0,07	1 1	
	100 39 1/4"	60 23 5/8"	10,2 4 1/8"	11,4 4 1/2"	300.AP.25.06	48	0,90 1,98	0,003 0,10	1 1	
	100 39 1/4"	80 31 1/2"	10,2 4 1/8"	11,4 4 1/2"	300.AP.25.08	50	1,50 3,30	0,004 0,14	1 1	
	140 55"	120 47 1/4"	10,2 4 1/8"	11,4 4 1/2"	300.AP.25.12	57	2,00 4,41	0,007 0,24	1 1	
	160 63"	140 55 1/8"	10,2 4 1/8"	11,4 4 1/2"	300.AP.25.14	61	2,20 4,85	0,009 0,31	1 1	
	180 70 3/4"	160 63"	10,2 4 1/8"	11,4 4 1/2"	300.AP.25.16	64	2,50 5,51	0,010 0,35	1 1	
 <p>Prolunga da aggiungere ai canali passacavi utilizzati negli allunghi laterali per raccordo con il canale scrivania extension for the cable channels code used on the extension tables for the connection to the desk's cable channel Elemento de unión para integrar a los canales pasacables usados en los alargos laterales, para la unión con el canal de la mesa Rallonge à ajouter aux goulottes utilisées avec les extensions latérales pour unir à la goulotte du bureau Verlängerung für Kabelkanäle für seitliche Verlängerungen für Anschluss am Kabelkanal des Schreibtischs Extensão para complementar os canais passa-cabos, utilizados nas extensões laterais para interligações com canal escrivania</p>		78 30 3/4"	9,5 3 3/4"	4,5 1 7/8"	300.AP.11.01	25	1,30 2,86	0,005 0,17	1 1	

DV818 Toledo

V04 cassetto drawer	W	H	A
---------------------	---	---	---

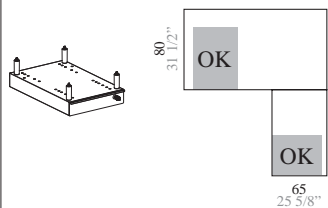
CASSETTIERE SOPPESE HANGING PEDESTAL		L. W.	P. D.	H. H.	CODICE CODE	V04	Kg. lb	m ³ ft ³	n. no.
	Cassettiera sospesa metallica con 1 cassetto FO	32,5 12 7/8"	52 20 1/2"	14,5 5 3/4"	818.CA.01.05	199	4,30 9,48	0,013 0,45	2 2
	1 metal drawers hanging pedestal								
	Cajonera colgante metalica con 1 cajon								
	Caisson-suspendu métallique 1 tiroir								
	Hängeschubladenelement aus Metall mit 1 Schüben								
Gaveteiro suspenso em metal com 1 gaveta									

V23 maniglia handle	Q		W	H	A
---------------------	---	---	---	---	---

V04 cassettiere pedestals	WN	HH
---------------------------	----	----

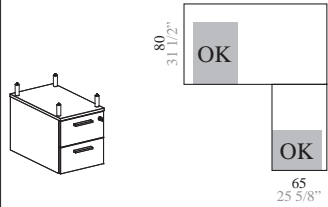
CASSETTIERE SOPPESE HANGING PEDESTAL		L. W.	P. D.	H. H.	CODICE CODE	V04 / V23	Kg. lb	m ³ ft ³	n. no.
	cassettiera sospesa 2 cassetti Q FO	33 13"	54 21 3/8"	37 14 5/8"	818.CS.11.03	203	18,90 41,67	0,097 3,42	2 2
	2 drawers hanging pedestal								
	cajonera colgante 2 cajones								
	caisson-suspendu 2 tiroirs								
	Hängeschubladenelement mit 2 Schüben								
gaveteiro suspenso, 2 gavetas									

M1	V01 modesty panel	WN	HH	GQ	RC	NM	TD
	V02 staffe brackets	W	H	A			

M2	V01 modesty panel	NO		
	V02 staffe brackets	W	H	A

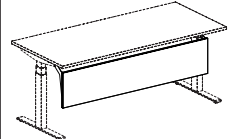
MODESTY PANELS MODESTY PANELS	LT TW	L. W.	P. D.	H. H.	CODICE CODE	CATEGORIA PREZZO / PRICE CATEGORY		Kg. lb	m ³ ft ³	n. no.
						M1	M2			
							140 55"			
160 63"	147 57 7/8"	1,8 3/4"	35 13 7/8"	818.MP.01.16	94		133	9,00 19,84	0,022 0,77	2 2
180 70 3/4"	167 65 3/4"	1,8 3/4"	35 13 7/8"	818.MP.01.18	96		138	9,40 20,72	0,024 0,84	2 2
modesty panel per scrivanie modesty panel for desks panel de protección para mesas voile de fond pour bureaux Knieblende für Tisch modesty panel para mesa										

DV818 Toledo

V01 top top

M1	WN	GQ	RC	NM	TD
M2	NO				

V04 scocche bodies	WN	HH	AN
---------------------------	----	----	----

V81 Verso Hand	Sx	Dx
-----------------------	----	----

V05 frontali drawers

M1	WN	GQ	RC	NM	AT	GS	RP	TD	VB
M2	NO								

V23 maniglia handle		W
		H
		A

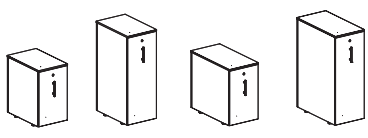
ORGATOWER ORGATOWER	L. W.	P. D.	H. H.	CODICE CODE	CATEGORIA PREZZO PRICE CATEGORY		Kg. lb	m ³ ft ³	n. no.
					M1	M2			
 <p>H.74 / P65 H. 15 3/4" / D. 25 5/8"</p> <p>H.115 / P65 H. 30 3/4" / D. 25 5/8"</p> <p>H.74 / P80 H. 45 3/4" / D. 31 1/2"</p> <p>H.115 / P80 H. 60 3/4" / D. 31 1/2"</p>	42 16 5/8"	65 25 5/8"	74 29 1/4"	505.TW.02.02	815	853	27,60 60,85	0,253 8,93	5 5
	42 16 5/8"	80 31 1/2"	74 29 1/4"	505.TW.02.03	908	946	30,60 67,47	0,308 10,88	5 5
	42 16 5/8"	65 25 5/8"	115 45 3/8"	505.TW.04.02	1.057	1.095	37,60 82,90	0,396 13,99	5 5
	42 16 5/8"	80 31 1/2"	115 45 3/8"	505.TW.04.03	1.158	1.196	42,60 93,93	0,485 17,13	5 5
Cassettini a estrazione totale del frontale									
Drawers with total frontal extraction									
Cajoneras con extracción frontal total									
Caissons à extraction frontale totale									
Vollauszug Schubkästen									
Gavetão com extração total do frontal									

V06	frontal panel frontal panel	9109	9110	9804	9806
-----	--------------------------------	------	------	------	------

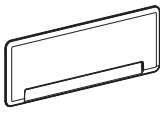
FRONTAL PANEL IN TESSUTO FONOASSORBENTE PER SCRIVANIE SOUNDPROOF FABRIC FRONTAL PANELS FOR SINGLE DESKS	L. W.	P. D.	H. H.	CODICE CODE	PREZZO PRICE	Kg. lb	m ³ ft ³	n. no.
 <p>frontal panel rettangolare rivestito in tessuto - per scrivanie rectangular frontal panel upholstered with fabric - for desks panel frontal rectangular tapizado en tejido - para mesas panneau-écran rectangulaire revêtu de tissu - pour bureaux rechteckige Sichtblende mit farbigem Stoffbezug - für Schreibtische panel frontal rectangular revestido em tecido - para mesa escritivanhas</p>	79 31 1/8"	3 1 1/4"	39 15 3/8"	300.FP.40.07	129	1,30 2,86	0,014 0,49	1 1
	99 39"	3 1 1/4"	39 15 3/8"	300.FP.40.09	169	1,70 3,74	0,018 0,63	1 1
	139 54 3/4"	3 1 1/4"	39 15 3/8"	300.FP.40.13	218	2,70 5,95	0,026 0,91	1 1
	159 62 5/8"	3 1 1/4"	39 15 3/8"	300.FP.40.15	228	3,10 6,83	0,029 1,02	1 1
	179 70 1/2"	3 1 1/4"	39 15 3/8"	300.FP.40.17	258	3,40 7,49	0,033 1,16	1 1
	139 54 3/4"	3 1 1/4"	59 23 1/4"	300.FP.50.13	303	4,10 9,04	0,047 1,66	1 1
	159 62 5/8"	3 1 1/4"	59 23 1/4"	300.FP.50.15	328	4,60 10,14	0,054 1,90	1 1

I frontal panels vanno completati con i morsetti specifici, da ordinare a parte

The frontal panels must be completed with specific clamps, to be ordered separately
Los paneles frontales se tienen que completar con las específicas abrazaderas, para pedir por separado
Les panneaux écran doivent être complétés avec étriers spécifiques, à commander à part
Die Sichtblenden müssen mit spezifischen Halterungen ergänzt werden, die separate bestellt werden müssen
Os painéis frontais são complementados com os mordentes específicos, a serem pedidos a parte

morsetti in nylon nylon clamps	W	A	G
-----------------------------------	---	---	---

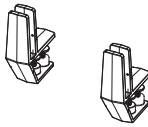
MORSETTI IN ABS PER FRONTAL PANEL ABS CLAMPS FOR FRONTAL PANELS	CODICE CODE	PREZZO PRICE	Kg. lb	m ³ ft ³	n. no.
 <p>coppia morsetti per piani (da utilizzare con tutte le serie operative) pair of clamps for working top (for use on all operative series) par de abrazaderas para sobre (para utilizar en todas las series operativas) pair d'étriers pour plateau (à utiliser sur tout lignes opérationnelles) Klemmenpaar für Platte (für alle Büroeinrichtungsprogramme) par de grampos para plano (para utilizar na todos linha operacional)</p>	300.FP.27.00	35	1,80 3,96	0,004 0,14	1 1

V04	staffe brackets	W	H	A
-----	--------------------	---	---	---

V06	frontal panel frontal panel	9109	9110	9804	9806
-----	--------------------------------	------	------	------	------

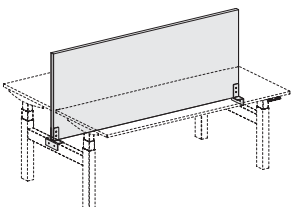
FRONTAL PANEL IN TESSUTO PER TAVOLI BENCH FABRIC FRONTAL PANELS FOR BENCH DESKS	L. W.	P. D.	H. H.	CODICE CODE	V06	Kg. lb	m ³ ft ³	n. no.
 <p>Frontal panel per bench, in melaminico rivestito in tessuto Fabric frameless screen for bench Panel frontal para bench, de melamina revestido en tejido Panneau de séparation revêtu en tissu pour bench Sichtblende für "Bench" Tisch, aus Melamin mit Stoffbezug Painel frontal para Bench, em melamina revestido em tecido</p>	140 55 1/8"	3 1 1/4"	70 27 5/8"	818.FR.21.14	433	20,22 44,58	0,043 1,51	2 2
	160 63"	3 1 1/4"	70 27 5/8"	818.FR.21.16	456	22,72 50,09	0,050 1,76	2 2
	180 70 7/8"	3 1 1/4"	70 27 5/8"	818.FR.21.18	478	25,22 55,61	0,056 1,97	2 2

FRONTAL PANEL IN TESSUTO PER TAVOLI BENCH

Fabric frontal panel for bench desk composition / Panel frontal en tejido para dos mesas enfrentadas / Panneau écran de tissu pour tables avec deux bureaux vis à vis / Sichtblenden auf Stoff für Schreibtische mit zwei gegenüber angeordneten Tischen / Painel frontal em tecido para mesas com dois escritaninhas contrapostas

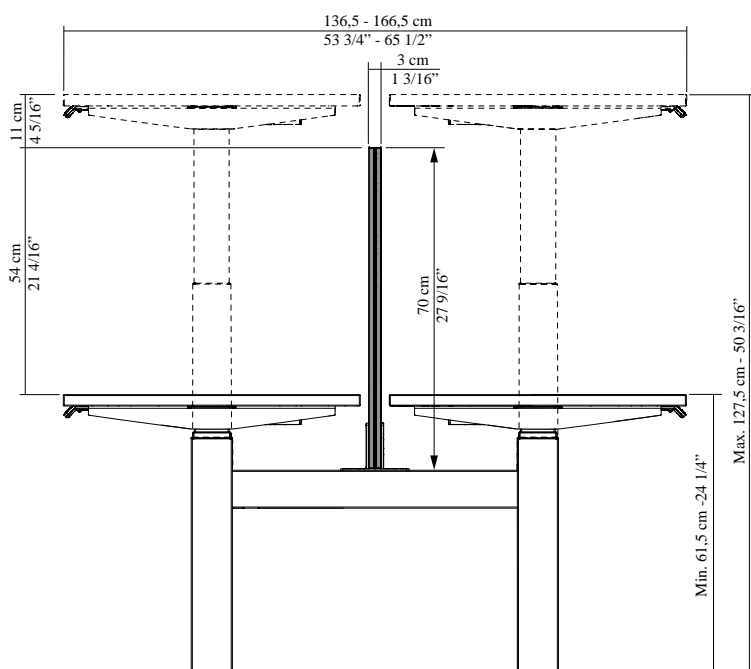
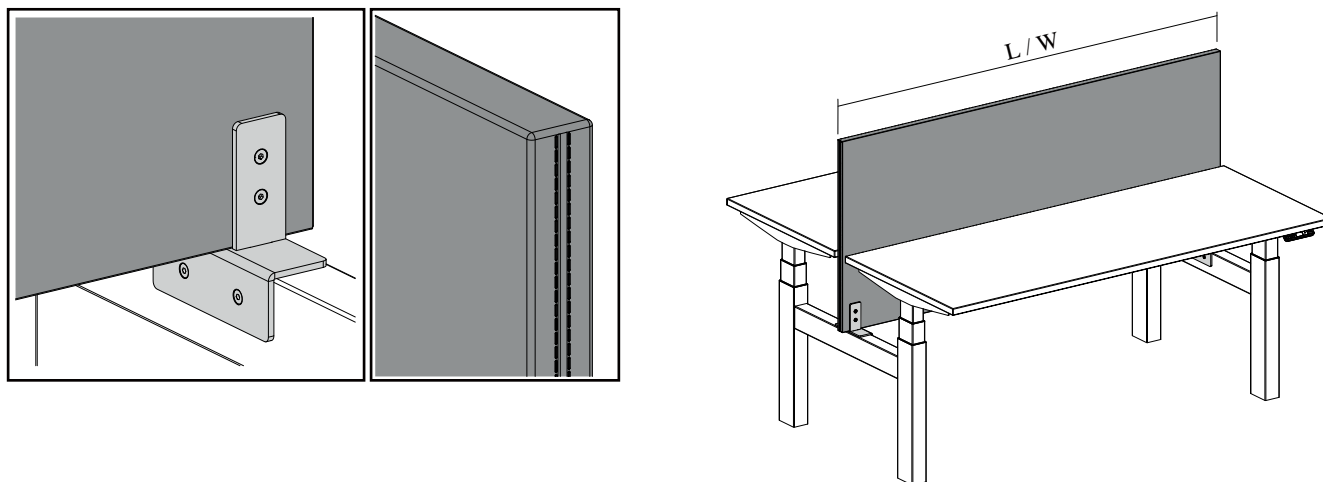

L/W	Cod.
140 cm - 55 1/8"	818.FR.21.14
160 cm - 63"	818.FR.21.16
180 cm - 70 7/8"	818.FR.21.18

